

MINOLTA

The essentials of imaging

www.minoltaeurope.com



DiMAGE S404

9224-2781-11 H-A201

E INSTRUCTION MANUAL

BEFORE YOU BEGIN

Thank you for purchasing this Minolta digital camera. Please take the time to read through this instruction manual so you can enjoy all the features of your new camera.

This manual contains information regarding products introduced before February, 2002. To obtain compatibility information for products released after this date, contact a Minolta Service Facility listed on the back cover of this manual.

Check the packing list before using this product. If any items are missing, immediately contact your camera dealer.

Minolta DiIMAGE S404 digital camera
AA alkaline batteries (set of four)
Neck strap NS-DG304
Lens cap LF-236
16MB CompactFlash card
AV cable AVC-100
USB cable USB-600
DiIMAGE software CD-ROM
ArcSoft PhotoImpression CD-ROM
DiIMAGE Image Viewer Utility instruction manual (PDF)
Camera manual (PDF)
Quick Reference Guide
Warranty card

Because the performance of alkaline batteries with digital cameras is low, the use of Ni-MH batteries is recommended. Although alkaline batteries are supplied with this product, its performance will be limited; only use alkaline batteries for test photographs or when Ni-MH batteries, the Minolta external battery pack, or the AC adapter are not available. Fully recharge the Ni-MH batteries just before using the camera.

FOR PROPER AND SAFE USE

Read and understand all warnings and cautions before using this product.

WARNING

Using batteries improperly can cause them to leak harmful solutions, overheat, or explode which may damage property or cause personal injury. Do not ignore the following warnings.

- Only use the batteries specified in this instruction manual.
- Do not install the batteries with the polarity (+/-) reversed.
- Do not use batteries which show wear or damage.
- Do not expose batteries to fire, high temperatures, water, or moisture.
- Do not attempt to short or disassemble batteries.
- Do not store batteries near or in metallic products.
- Do not mix batteries of different types, brands, ages, or charge levels.
- Do not charge alkaline batteries.
- When recharging rechargeable batteries, only use the recommended charger.
- Do not use leaking batteries. If fluid from the batteries enters your eye, immediately rinse the eye with plenty of fresh water and contact a doctor. If fluid from the batteries makes contact with your skin or clothing, wash the area thoroughly with water.

- Use only the specified AC adapter within the voltage range indicated on the adapter unit. An inappropriate adapter or current may cause damage or injury through fire or electric shock.
- Do not disassemble this product. Electric shock may cause injury if a high voltage circuit inside the product is touched.
- Immediately remove the batteries or unplug the AC adapter and discontinue use if the camera is dropped or subjected to an impact in which the interior, especially the flash unit, is exposed. The flash has a high voltage circuit which may cause an electric shock resulting in injury. The continued use of a damaged product or part may cause injuries or fire.
- Keep batteries or small parts that could be swallowed away from infants. Contact a doctor immediately if an object is swallowed.
- Store this product out of reach of children. Be careful when around children, not to harm them with the product or parts.
- Do not fire the flash directly into the eyes. It may damage eyesight.

FOR PROPER AND SAFE USE

- Do not fire the flash at vehicle operators. It may cause a distraction or temporary blindness which may lead to an accident.
- Do not use the monitor while operating a vehicle or walking. It may result in injury or an accident.
- Do not use this product in a humid environment, or operate this product with wet hands. If liquid enters the product, immediately remove the batteries or unplug the AC adapter and discontinue use. The continued use of a product exposed to liquids may cause damage or injury through fire or electric shock.
- Do not use the product near inflammable gases or liquids such as gasoline, benzine, or paint thinner. Do not use inflammable products such as alcohol, benzine, or paint thinner to clean the product. The use of inflammable cleaners and solvents may cause an explosion or fire.
- When unplugging the AC adapter, do not pull on the power cord. Hold the adapter unit when removing it from an outlet.
- Do not damage, twist, modify, heat, or place heavy objects on the AC adapter cord. A damaged cord may cause damage or injury through fire or electric shock.
- If the product emits a strange odor, heat, or smoke, discontinue use. Immediately remove the batteries taking care not to burn yourself as the batteries become hot with use. The continued use of a damaged product or part may cause injuries or fire.
- Take the product to a Minolta Service Facility when repairs are required

CAUTION

- Do not use or store the product in a hot or humid environment such as the glove compartment or trunk of a car. It may damage the product and batteries which may result in burns or injuries caused by heat, fire, explosion, or leaking battery fluid.
- If batteries are leaking, discontinue use of the product.
- The camera temperature rises with extended periods of use. Care should be taken to avoid burns.
- Burns may result if the CompactFlash card or batteries are removed immediately after extended periods of use. Turn the camera off and wait for it to cool.
- Do not fire the flash while it is in contact with people or objects. The flash unit discharges a large amount of energy which may cause burns.
- Do not apply pressure to the LCD monitor. A damaged monitor may cause injury, and the liquid from the monitor may cause inflammation. If liquid from the monitor makes contact with skin wash the area with fresh water. If liquid from the monitor comes in contact with the eyes, immediately rinse the eyes with plenty of water and contact a doctor.
- When using the AC adapter, insert the plug securely into the electrical outlet.
- Do not use if the AC adapter cord is damaged.
- Do not cover the AC adapter. A fire may result.
- Do not obstruct access to the AC adapter; this can hinder the unplugging of the unit in emergencies.
- Unplug the AC adapter when cleaning or when the product is not in use.

TABLE OF CONTENTS

ABOUT THIS MANUAL

The basic operation of this camera is covered between pages 10 and 27. This section of the manual covers the camera parts, preparation of the camera for use, and the basic camera operation for recording, viewing, and deleting images.

The auto-recording mode section covers all the basic functions of the camera in this mode and the multi-function recording mode. Take time to read this section before moving on to the multi-function recording mode section. The other sections, movie recording mode, playback mode, setup mode, and data transfer mode, can be read as needed.

Many of the features of this camera are controlled with menus. The menu navigation sections concisely describe how to change menu settings. Descriptions of the settings immediately follow the navigation sections.

Throughout the text are shooting tips and camera notes. Shooting tips give advice and information on photography and how to use the camera to achieve the best results. Camera notes cover details on camera operation.

Names of parts	
Camera body	10
Viewfinder	12
Mode dial	12
Data panel	13
LCD monitor display	14
Getting up and running.....	15
Attaching the neck strap and lens cap	15
Changing batteries	16
Battery condition indicator	17
Auto power save	17
External power supplies (sold separately).....	18
Changing the CompactFlash card.....	18
Auto-recording mode - basic operation	20
Handling the camera	20
Setting the camera to record images automatically	21
Zoom lens and digital zoom	22
Basic recording operation.....	23
Focus lock.....	24
Focus range.....	24
Focus signals.....	25

Special focusing situations	25
Quick view	26
Quick-view display	27
Deleting images in quick view	27
Digital-subject-program button	28
Flash modes	30
Flash range - auto-recording mode	31
Flash signals	31
Camera-shake warning	31
Drive modes	32
Self-timer	33
Remote control (sold separately)	34
Continuous advance	35
Bracketing	36
Display button - recording mode	37
Navigating the auto-recording mode menu	38
Image size	40
Image quality	41
Image-file size and CompactFlash card capacity	42
Voice memo	43
Date imprinting	44
Instant playback	45
Exposure compensation	46
What is an Ev? What is a stop?	47
Multi-function recording mode - advanced operation	48
Autofocus areas and control	48
Navigating the multi-function recording mode menu	50
Exposure modes	52
Program	52
Aperture priority - A	52
Manual exposure - M	53
White balance	54
Automatic white balance	54
Preset white balance	54
Custom white balance	55

TABLE OF CONTENTS

Focus modes	56
Camera sensitivity - ISO	57
Flash range and camera sensitivity	57
Full-time AF	58
Metering modes	58
Exposure bracketing	59
Digital zoom and image size	59
Image control - colour, sharpness, contrast, & saturation	60
Bulb exposures	61
A short guide to photography	62
Movie recording	64
Recording movies with the RC-3 remote control (sold separately)	65
Playback mode - viewing and editing images	66
Single-frame playback display	66
Histogram display	67
Movie playback display	67
Viewing pictures	68
Viewing movies	69
Deleting images	69
Display button - playback mode	70
Enlarged playback	71
Navigating the playback-mode menu	72
Playback-mode menu - basic	74
Deleting images	74
Locking images	75
Changing the index playback format	75
Playback-mode menu - custom 1 (Slide Show)	76
Playback-mode menu - custom 2	78
About DPOF	78
Creating a DPOF print order	78
Ordering an index print	79
Canceling a DPOF print order	79
Copying images	80
Frame-selection screen	81
Viewing images on a television	82

Setup mode - controlling the camera's operation.....	83
Navigating the setup menu.....	84
Setup menu – basic.....	86
LCD monitor brightness.....	86
Formatting CompactFlash cards.....	86
Auto power save.....	87
Audio signals.....	87
Volume.....	87
Language.....	87
Setup menu - custom 1.....	88
File number memory.....	88
Select folder.....	88
Setup menu - Custom 2.....	89
Resetting the camera.....	89
Setting the date and time.....	90
Setting the date format.....	91
Video output.....	91
Data-transfer mode - connecting to a computer.....	92
Arcsoft PhotoImpression system requirements.....	93
QuickTime system requirements.....	93
Connecting the camera to a computer.....	94
Connecting to Windows 98 and 98SE.....	96
Automatic installation.....	96
Manual installation.....	97
Connecting to Mac OS 8.6.....	99
Auto power save (data-transfer mode).....	99
CompactFlash card folder organization.....	100
Disconnecting the camera from the computer.....	102
Windows 98 and 98SE.....	102
Windows Me, 2000 Professional, and XP.....	102
Macintosh.....	103
Changing the CompactFlash card (data-transfer mode).....	104
Troubleshooting.....	105
About Ni-MH batteries.....	107
Removing the driver software - Windows.....	108
Care and storage.....	109
Technical specifications.....	114

NAMES OF PARTS

CAMERA BODY

* This camera is a sophisticated optical instrument. Care should be taken to keep these surfaces clean.
Please read the care and storage instructions in the back of this manual (p. 109).

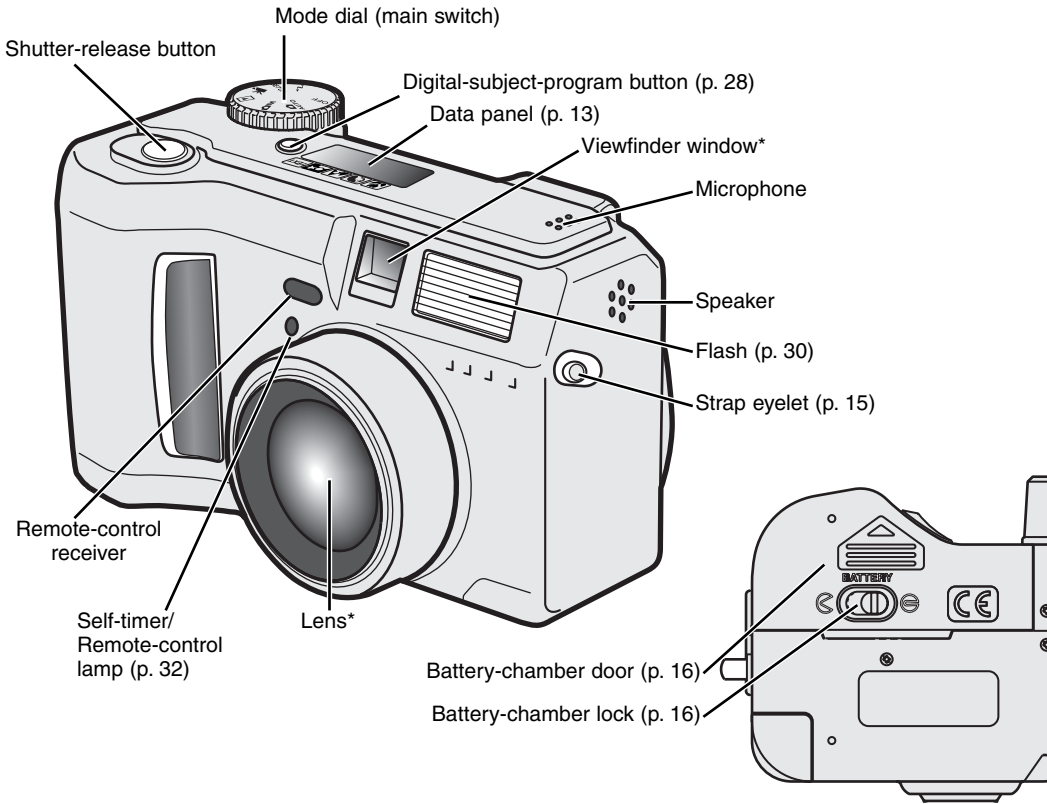

Flash mode/Magnification button (p. 30, 71)

CCD plane

Drive-mode button (p. 32)

Exposure-compensation button (p. 46)

Viewfinder* (p. 12)

LCD monitor*
(p. 14)

Controller

Menu button

QV/ Delete button (p. 26)

Display button (p. 37, 70)

Access lamp

Card-slot door release

DC terminal cover (p. 18)

Card-slot door (p. 18)
The USB port and AV-out terminal
are located behind the card-slot
door.

Tripod socket

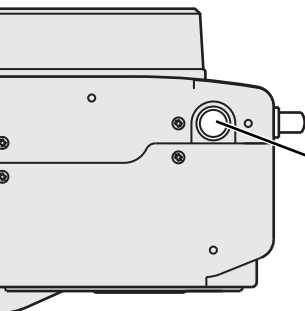

NAMES OF PARTS

VIEWFINDER

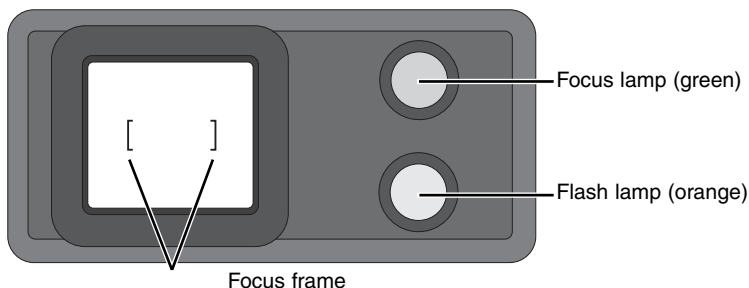



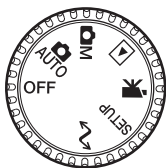

Because the optical viewfinder and the lens are slightly separated, the image seen through one is not exactly the same as the other; this is called parallax. Parallax can cause errors in framing at close distances and is more pronounced at longer focal lengths. When the subject is closer than 1m (3ft) at the wide-angle lens positions or 3m (9.8ft) at the telephoto lens position, use the LCD monitor to compose the image; because the lens creates the monitor image, it does not suffer from parallax.

MODE DIAL

This dial gives direct and easy access to the camera's major modes. It also acts as the main switch





-  **AUTO** Auto-recording mode (p. 20)
-  **M** Multi-function recording mode (p. 48)
-  Playback mode (p. 66)
-  Movie-recording mode (p. 64)
- SETUP** Setup mode (p. 83)
-  Data-transfer mode (p. 92)

DATA PANEL

 Digital-subject-program indicators (p. 28)

 White-balance indicator (p. 54)

 Manual-focus indicator (p. 56)

 Camera-sensitivity indicator (p. 57)

 Spot-metering indicator (p. 58)

 Flash-mode indicators (p. 30)
AUTO

SIZE  Image-size display (p. 40)

QUAL  Image-quality display (p. 41)

 Drive-mode indicators (p. 32)

 Microphone indicator (p. 43)

 Battery-condition indicator (p. 17)

 Exposure-compensation indicator (p. 46)

AM Exposure-mode indicators (p. 52)

Digital-subject-program icons (p. 28)

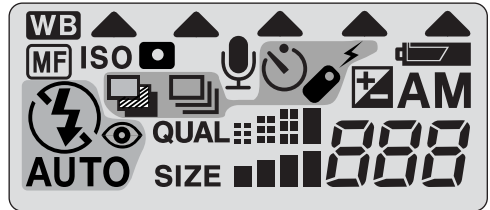

Frame counter
(p. 42)

NAMES OF PARTS

LCD MONITOR DISPLAY

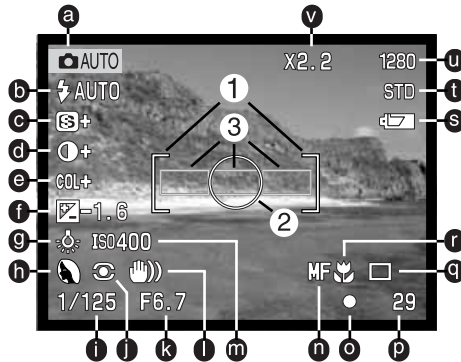

- a. Mode indicator (p. 12)
- b. Flash-mode indicator (p. 30)
- c. Sharpness display (p. 60)
- d. Contrast-compensation display (p. 60)
- e. Colour-saturation-compensation display (p. 60)
- f. Exposure-compensation display (p. 46)
- g. White-balance indicator (p. 54)
- h. Exposure-mode (p. 52)/
Digital-subject-program indicators (p. 28)
- i. Shutter-speed display
- j. Metering-mode indicator (p. 58)
- k. Aperture display
- l. Camera-shake warning (p. 31)
- m. Camera-sensitivity (ISO) display (p. 57)
- n. Manual-focus indicator (p. 56)
- o. Focus signal (p. 25)
- p. Frame counter (p. 42)
- q. Drive-mode indicator (p. 32)
- r. Macro indicator (p. 28)
- s. Battery-condition indicator (p. 17)
- t. Image-quality indicator (p. 41)
- u. Image-size display (p. 40)
- v. Digital-zoom display (p. 22)
- 1. Focus frame (p. 48)
- 2. Spot metering area (p. 58)
- 3. AF sensors (p. 23)

GETTING UP AND RUNNING

ATTACHING THE NECK STRAP AND LENS CAP

Attach the small strap to the lens cap by passing one of the small loops through the eyelet on the cap (1) and then passing the other loop through the first loop (2) and tightening.

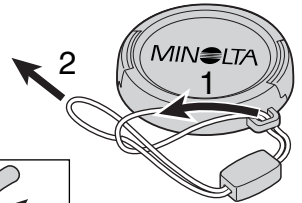

Attach the camera strap to the strap eyelets as shown.

- Make sure the neck strap passes through the loop of the lens-cap strap.
- Always keep the camera strap around your neck in the event that you drop the camera.

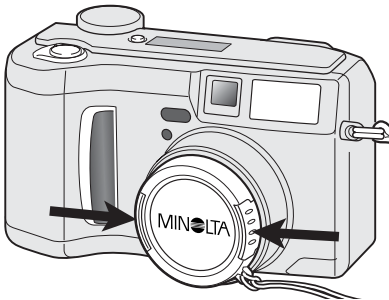
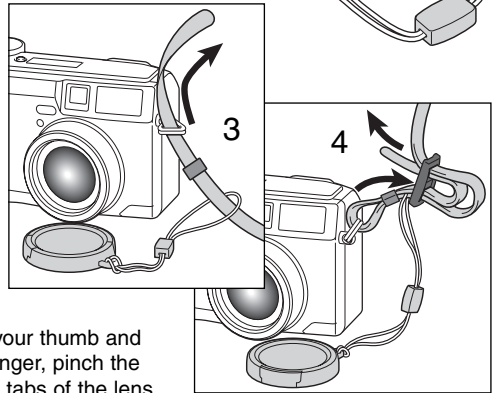

Using your thumb and index finger, pinch the outside tabs of the lens cap to remove or attach.

- When the camera is not in use, always replace the lens cap.

GETTING UP AND RUNNING

CHANGING BATTERIES

This digital camera uses four AA-size alkaline or Ni-MH batteries. Ni-MH batteries are recommended because of longer life. When using Ni-MH batteries, fully recharge them with a battery charger suitable for complex electronic equipment. Please consult your vendor about an appropriate charger.

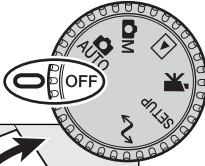

When replacing batteries, the mode dial should be in the off position.

- If the camera is not turned off when replacing exhausted batteries, the low-battery warning may not reset.

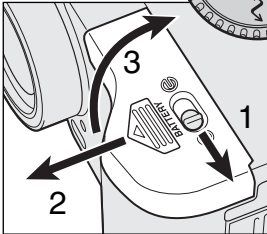

Open the battery-chamber door by moving the battery-chamber lock (1) to the open position (☞). Slide the door forward (2) to release the safety catch; the door should spring open (3).

Insert the batteries.

- Make sure the positive and negative battery terminals are orientated as illustrated on the diagram in the battery chamber.

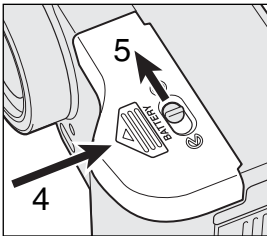
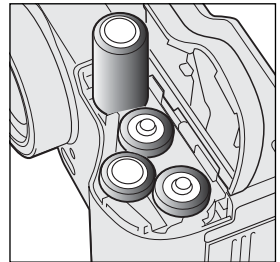

Close the battery-chamber door and slide it back toward the body (4) to engage the safety catch. Move the lock lever (5) to the close position (☐).

- After installing the batteries, the set-time/date message may appear on the monitor. The clock and calendar are set in the custom 2 section of the setup menu (p. 84).

BATTERY CONDITION INDICATOR

This camera is equipped with an automatic battery-condition indicator. When the camera is on, the battery-condition indicator appears on the data panel and monitor. The monitor icon will change from white to red when battery power is low. If the data panel and monitor are blank, the batteries may be dead or installed incorrectly.



Full-battery icon - the batteries are fully charged. This icon is displayed for five seconds on the monitor when the camera is turned on. The icon remains on the data panel.



Low-battery warning - battery power is very low. The batteries should be replaced as soon as possible. This warning automatically appears and remains on the monitor until the batteries are changed.

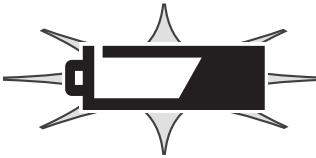

Blinking low-battery icon - when displayed on the data panel with no other icons, power is insufficient for camera operation. The shutter will not release. When replacing exhausted batteries, wait thirty seconds between removing the old batteries and inserting the new ones.

When installing batteries, make sure the battery terminals are clean. Residue or dirt on the terminals can sometimes cause a false low-battery warning. Always use a clean, dry cloth to clean batteries.

AUTO POWER SAVE

To conserve battery power, the camera will turn off displays and unnecessary functions if an operation is not made within a certain period. The LCD monitor will turn off after thirty seconds. The data panel turns off after one minute. To restore the displays, press any button or key, or turn the mode dial to another position. The length of the auto-power-save period for the data panel can be changed in the basic section of the setup menu (p. 84).

GETTING UP AND RUNNING

EXTERNAL POWER SUPPLIES (SOLD SEPARATELY)

The AC Adapter allows the camera to be powered from an electrical household outlet. The AC Adapter is recommended when the camera is interfaced with a computer or during periods of heavy use. AC Adapter model AC-1L is for use in North America, Japan, and Taiwan and AC-2L is for use in all other areas.

The External High-power Battery Pack Kit EBP-100 is a portable source of power for the camera. The kit contains a high-power lithium-ion battery, holder, and charger. The battery and charger are also available separately. This battery pack will significantly extend the operating time of the camera.

**Do not change the power supply while the camera is on.
Always turn off the camera before changing between power supplies.**

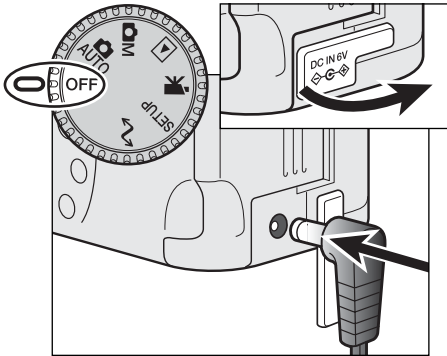

Remove the DC terminal cover from the left.

- The cover is attached to the body to prevent loss.

Insert the mini plug of the AC adapter or battery pack into the DC terminal.

- Always remove exhausted batteries before connecting an external power supply. Always wait thirty seconds between removing the old batteries and plugging in the external power source.

Insert the AC adapter plug into an electrical outlet.

CHANGING THE COMPACTFLASH CARD

A type I CompactFlash card must be inserted for the camera to operate. If a card has not been inserted, a no-card warning will automatically be displayed on the monitor and three dashes (---) will be displayed on the data-panel frame counter. For CompactFlash card care and storage, see page 109.

Always turn off the camera and confirm the access lamp is not lit before inserting or removing a CompactFlash card, otherwise the card may be damaged, and data lost.

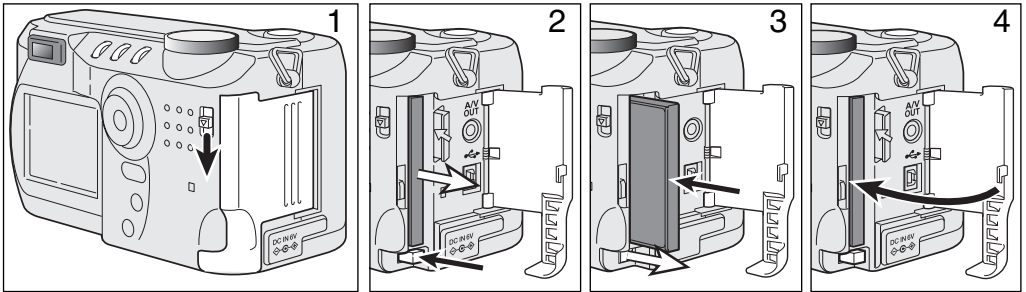

Slide the card-slot door release down to open the card-slot door (1).

To eject a CompactFlash card, press the card-eject lever (2). The card can now be pulled out.

- Take care when removing the card as it becomes hot with use.

Insert the CompactFlash card into the card slot until the card-eject lever pops out (3).

- Insert the card so the face is toward the front of the camera. Always push the card in straight, never at an angle. Never force the card. If the card does not fit, check that it is orientated correctly.

Close the card-slot door (4).

If the card-not-recognized message appears, the inserted card in the camera may need to be formatted. A card used in another camera may have to be formatted before being used. If the unable-to-use-card message appears, the card is not compatible with the camera and cannot be formatted. A card can be formatted in the basic section of the setup menu (p. 84). When a card is formatted, all the data on the card is permanently erased.

AUTO-RECORDING MODE BASIC OPERATION

This section covers the basic operation of this camera. Thoroughly familiarize yourself with the operations in this section before moving on to the other sections in the manual.

The sophisticated technology employed in the auto-recording mode frees the photographer from complicated camera settings to be able to simply concentrate on the subject and composition. Although automated, the camera's operation can be changed to meet various conditions as well as to suit personal shooting preferences.

To set the camera's clock and calendar, see the navigating the setup menu section on page 84. The menu language can also be changed on the setup menu.

HANDLING THE CAMERA

While using the viewfinder or LCD monitor, grip the camera firmly with your right hand while supporting the body with your left hand. Keep your elbows at your side and your feet shoulder-width apart to hold the camera steadily.

When taking vertical pictures, hold the camera so that the flash is above the lens with the grip to the bottom. Take care not to cover the lens with your fingers or the strap.

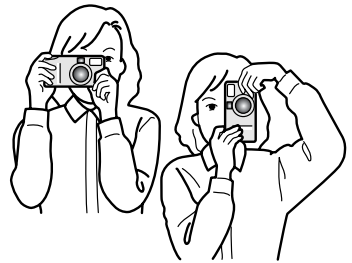

SETTING THE CAMERA TO RECORD IMAGES AUTOMATICALLY

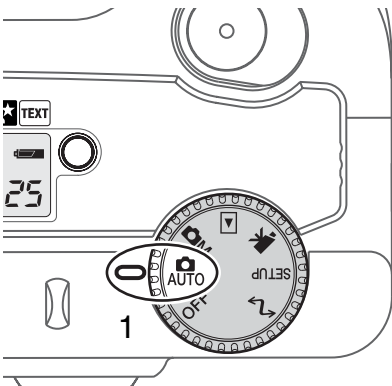

Turn the mode dial to automatic recording (1); all camera operations are now fully automatic. The autofocus, exposure, and imaging systems will work together to bring beautiful results effortlessly.

While many of the camera's systems in this mode are automatic, the camera's operation can be optimized to different subjects very simply with the digital subject program button (p. 28). The flash mode (p. 30) and drive mode (p. 32) can also be changed. Image size and quality can be set on the auto-recording mode menu (p. 38).

Exposure mode	Program	Fixed
Metering mode	Multi-segment	Fixed
Camera sensitivity (ISO)	Auto	Fixed
Flash mode	Auto flash	Can be changed*
Focus area	Wide focus area	Fixed
Focus control	Autofocus	Fixed
Drive mode	Single-frame advance	Can be changed*
Exposure compensation	0.0	Can be adjusted*
Sharpness	Normal	Fixed
Colour mode	Colour	Fixed
White balance	Auto	Fixed

* Changes to the flash or drive mode will reset when the mode dial is turned to another position. Adjustments made with exposure compensation will be reset to 0.0 when the camera is turned off or changed to another mode.

AUTO-RECORDING MODE

ZOOM LENS AND DIGITAL ZOOM

This camera is equipped with a 7.15 to 28.6mm optical zoom. This is equivalent to a 35 to 140mm zoom lens on a 35mm camera. In 35mm photography, focal lengths below 50mm are referred to as wide-angle; the angle of view is larger than that of the human eye. Above 50mm is referred to as telephoto and makes distant objects appear closer. The effect of the optical zoom is visible in both the viewfinder and LCD monitor.

Assisting the optical zoom is a 2.2X digital zoom. The effect of the digital zoom doubles the power of the telephoto position of the optical zoom giving the equivalent of a 308mm lens on a 35mm camera. The effect of the digital zoom is visible on the LCD monitor only. This digital-zoom function is canceled if the LCD monitor is turned off (p. 37). The digital zoom can be disabled in the auto-recording menu (p. 38). In the multi-function recording mode, the zoom can be disabled in the custom 1 section of the multi-function recording mode menu (p. 50).

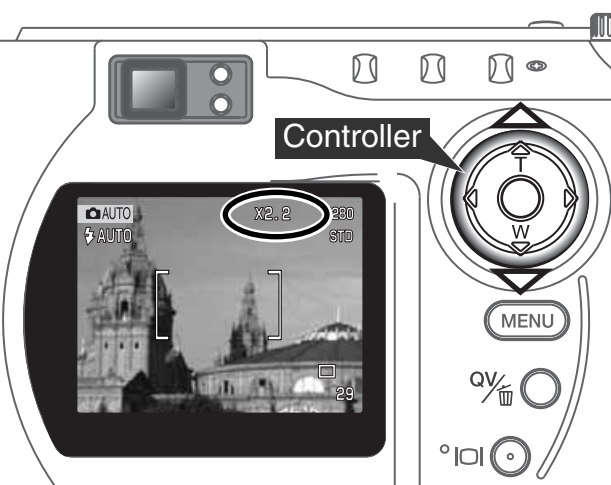

The zoom lens is operated by the controller. Pressing the up key (T) will zoom in to the telephoto position of the lens. Pressing the down key (W) will zoom out to the wide-angle position.

At the maximum telephoto position, pressing the up key (T) will activate the digital zoom.

- X2.2 will be displayed in the top right corner of the monitor.
- To cancel the digital zoom, press the down key.

BASIC RECORDING OPERATION

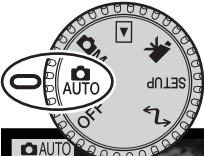

With the mode dial set to auto recording, the camera will be on and the LCD monitor will activate.

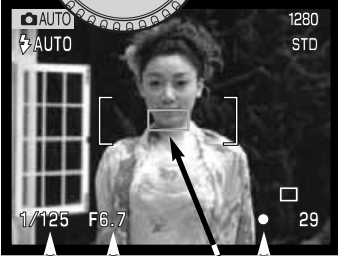

Place the subject within the focus frame.

- The focus-lock function (p. 24) can be used with off-center subjects.
- Make sure the subject is within the focus range of the lens: 0.5m - ∞ (wide-angle position), 0.9m - ∞ (telephoto position. For subjects closer than 0.6m, use the macro function (p. 28).
- If the subject is closer than 1m at the wide-angle lens position or 3m at the telephoto lens position, use the LCD monitor to frame the subject (p. 12).



Press the shutter-release button partway down (1) to lock the focus and exposure.

- The focus signals (p. 25) on the monitor will confirm the focus. If the focus signal is red, the camera was unable to focus on the subject. Repeat the previous steps until the signal is white.
- When the focus is set, an AF sensor will briefly appear on the live image to indicate the point of focus.
- The shutter speed and aperture value will change from white to black indicating the exposure is locked.

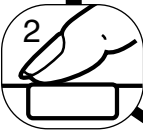

Press the shutter-release button all the way down (2) to take the picture.

- The access lamp will glow indicating image data is being written to the CompactFlash card. Never remove a CompactFlash card while data is being transferred.

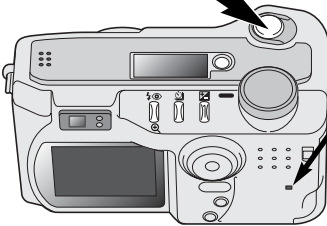

AUTO-RECORDING MODE

FOCUS LOCK

The focus-lock function is used when the subject is off-center and outside the focus frame. Focus lock may also be used when a special focusing situation prevents the camera from focusing on the subject. This function is controlled with the shutter-release button.

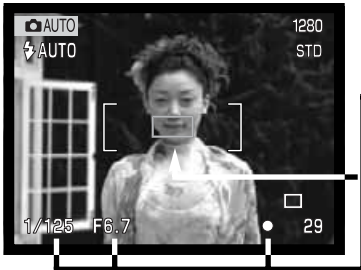

Place the subject within the focus frame. Press and hold the shutter-release button partway down.

- The focus signals will indicate that the focus is locked. The shutter speed and aperture value will change from white to black indicating the exposure is locked.
- When the focus is set, an AF sensor will briefly appear on the live image to indicate the point of focus.

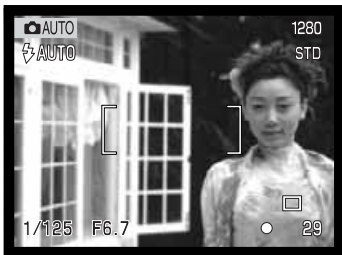

Without lifting your finger from the shutter-release button, recompose the subject within the image area. Press the shutter-release button all the way down to take the picture.

FOCUS RANGE



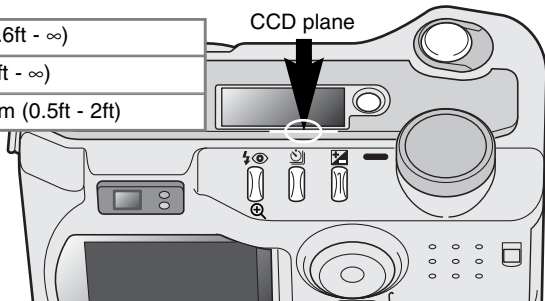

Wide-angle lens position	0.5m - ∞ (1.6ft - ∞)
Telephoto lens position	0.9m - ∞ (3ft - ∞)
Macro mode (p. 28)	0.16m - 0.6m (0.5ft - 2ft)

All distances are measured from the CCD



FOCUS SIGNALS

This digital camera has a quick, accurate autofocus system. The focus icon in the lower right corner of the LCD monitor and the green focus lamp next to the viewfinder indicate the focus status.

 	Focus icon: white Focus lamp: steady	Focus confirmed.
 	Focus icon: red Focus lamp: blinking	Cannot focus. The subject is too close or a special situation is preventing the AF system from focusing.

- The shutter can be released even if the camera cannot focus on the subject.
- When the AF system cannot focus, the focus is set to infinity. When the flash is in use, the focus is set between 3.0 and 3.8m. In this case, focus lock can be used with an object at the same distance as the main subject or the camera can be focused manually in the multi-function recording mode (p. 56).

SPECIAL FOCUSING SITUATIONS

The camera may not be able to focus in certain situations. If the autofocus system cannot focus on a subject, the focus icon will turn red. In this situation the focus-lock function can be used to focus on another object at the same distance as your main subject, and then the image can be recomposed to take the picture.

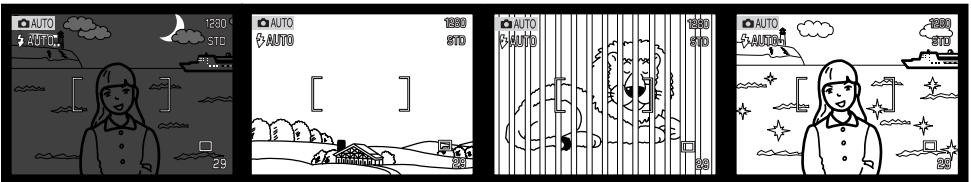

The subject is too dark.

The subject in the focus frame is low in contrast.

Two subjects at different distances overlap in the focus frame.

The subject is near a very bright object or area.

AUTO-RECORDING MODE

QUICK VIEW

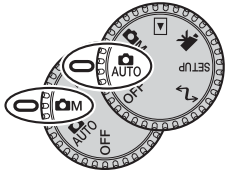

Captured images can be viewed in auto-recording and multi-function recording mode. Simply press the QV/delete button to access the images. The date and time of capture, frame number, printing status, lock status, image size and image quality are displayed with the images. The histogram and shooting data of the image can also be displayed in Quick View.



Press the QV/delete button to play back the recorded images.



Use the left/right keys of the controller to scroll through the images.

- Pressing the display button switched between displaying the image with and without information.



Press the up key to see the histogram of the displayed image.

- When the histogram is displayed, the left/right keys cannot scroll to the next image. Press the down key to cancel the histogram display.



To return to the recording mode, press the menu button or shutter-release button.

—Controller

—Menu button

—QV/Delete button

—Display button

QUICK-VIEW DISPLAY

To view the histogram, press the up key.



Mode indicator

Image size (p. 40)

Image quality (p. 41)

Aperture value

Shutter speed

White-balance setting (p. 54)

Sensitivity setting (p. 57)

Degree of exposure compensation (p. 46)

Folder name (p. 100)

Folder number - image file number

Histogram (p. 67)

Time of capture

Date of capture

Voice-memo icon (p. 43)

Lock icon (p. 75)

Print icon (p. 78)

Frame number/total number of images

DELETING IMAGES IN QUICK VIEW

In quick view, the displayed image can be deleted. When selecting an image for deletion, a confirmation screen will appear before the operation is executed.

Once deleted, an image cannot be recovered.



To delete a displayed image, press the QV/delete button.

- A confirmation screen will appear.



Use the left/right keys to highlight "YES."

- "NO" will cancel the operation.



Press the controller to delete the image.



AUTO-RECORDING MODE

DIGITAL-SUBJECT-PROGRAM BUTTON

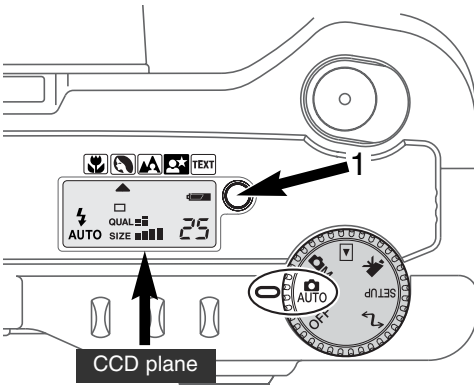

The digital-subject-program button (1) optimizes the camera's performance for various conditions and subjects. Exposure, white-balance, and image-processing systems work in unison for beautiful results.

Pressing the subject-program button cycles through the modes: macro, portrait, landscape, night portrait, text, macro & text, and the original exposure mode. A pointer will indicate the active subject program. The subject program will remain in effect until it is changed or the mode dial is turned to another position. Except for macro, digital subject programs cannot be used in the multi-function recording mode.

While camera performance is optimized for each shooting condition, some changes can be made to camera settings with subject programs. The flash mode

(p. 30) can be changed and the exposure can be altered using the exposure-compensation function (p. 46). In extreme lighting conditions, changes in exposure compensation may not produce the intended results in the portrait, night portrait, or text modes. The camera-shake warning (p. 31) may appear in macro, landscape, night portrait, or text modes.



MACRO - used for close-up photography between 16 and 60 cm from the CCD. When the macro mode is selected, the lens will automatically zoom to the correct position. The zoom position cannot be changed. The LCD monitor should be used to compose the picture and will automatically activate if off. The viewfinder cannot be used because of parallax. The flash is set to flash cancel (p. 30). Fill-flash can be used, but can cause extreme overexposure and uneven illumination.



PORTRAIT - optimized to reproduce soft skin tones and a slight defocusing of the background. The flash mode can be changed (p. 30).

- Most portraits look best at a telephoto setting; longer focal lengths do not exaggerate facial features and the shallower depth of field softens the background.



NIGHT PORTRAIT - for deep, subtle night scenes. When used with fill-flash, the subject and background exposures are balanced.

- When taking pictures of a landscape at night, use a tripod to eliminate blurring from camera shake. To take portraits with night scenes, set the flash mode to fill-flash (p. 30). **ASK** your subject not to move after the flash burst; the shutter will still be open for the background exposure.



LANDSCAPE - optimized to produce sharp, colourful landscapes. The flash mode is set to flash cancel. Fill-flash can be used (p. 30).

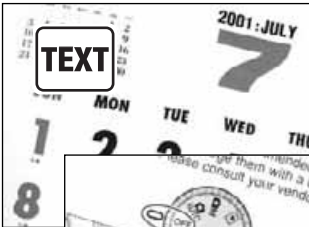

TEXT - for the crisp reproduction of black text on white backgrounds. The flash mode is set to flash cancel (p. 30). Fill-flash can be used.

- Use a tripod to eliminate camera shake and ensure the sharpest images.

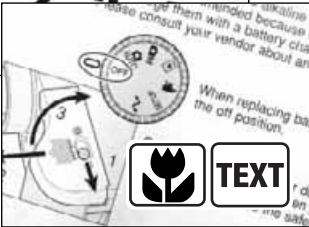

MACRO & TEXT - for close-up images of text between 16cm to 60cm from the CCD. Two pointers will indicate the combined modes on the data panel and both the macro and text icons will be displayed on the LCD monitor.









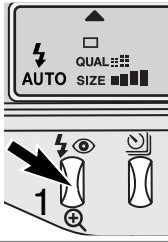



- Use a tripod to ensure the sharpest images.

AUTO-RECORDING MODE

FLASH MODES

To set the flash mode, simply press the flash mode button (1) on the back of the camera until the desired mode is displayed.



LCD monitor	Data panel	
 AUTO	 AUTO	Autoflash
		Fill-flash
		Flash cancel
 AUTO	 AUTO 	Autoflash with red-eye reduction
 	 	Fill-flash with red-eye reduction

Autoflash - the flash fires automatically in low-light and backlit conditions.

Fill-flash - the flash fires with each exposure regardless of the amount of ambient light. Fill-flash can be used to reduce harsh shadows caused by strong direct light or sunshine.



Flash cancel - the flash will not fire. Use flash cancel when flash photography is prohibited, natural light is desired to illuminate the subject, or the subject is beyond the flash range. The camera-shake warning may appear when flash cancel is selected (p. 31).

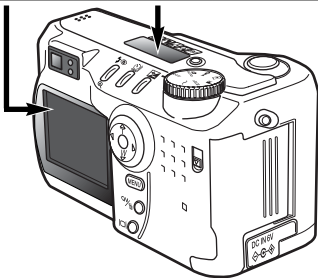

Red-eye reduction - the flash fires twice before the main flash burst to reduce red-eye; an effect caused by light reflected from the retina. Use in low-light conditions when taking photographs of people or animals. The pre-flashes contract the pupils of the subject's eyes.

FLASH RANGE - AUTO-RECORDING MODE

The camera will automatically control the flash output. For well-exposed images, the subject must be within the flash range. Because of the optical system, the flash range is not the same at the lens' wide-angle position as it is at the telephoto position.

Wide-angle position	0.5m ~ 3.5m (1.6 ft. ~ 11.5 ft.)
Telephoto position	0.9m ~ 3.0m (3.0 ft. ~ 9.8 ft.)

At the wide-angle lens position, when using the flash with subjects closer than 1m (3ft.), vignetting can occur. A slight shadow or shading may be apparent at the bottom of a horizontal image.

FLASH SIGNALS

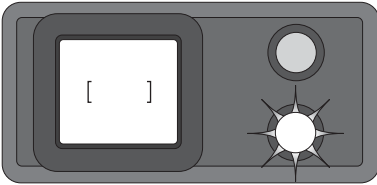

The orange flash lamp next to the viewfinder indicates the status of the flash. When the lamp glows steadily, the flash is charged and ready to fire. When the lamp blinks quickly, the flash is charging and the shutter will not release. The flash lamp is also used as a camera-shake warning, see below.

CAMERA-SHAKE WARNING

If the shutter speed falls below the point where the camera can be safely hand held, the camera-shake warning will appear on the LCD monitor and the orange focus lamp will blink slowly. Camera shake is slight blurring caused by subtle hand motion and is more pronounced at the telephoto setting of the lens than at the wide-angle setting. Although the warning appears, the shutter can still be released. If the warning appears, the following steps can be taken:

- Place the camera on a tripod.
- Use the built-in flash.
- Zoom the lens towards the wide-angle position until the warning disappears.



AUTO-RECORDING MODE

DRIVE MODES

The drive modes control the rate and method images are captured. Icons indicating the selected drive mode appear on the data panel and LCD monitor.

To change the drive mode, simply press the drive-mode button (1) on the back of the camera until the desired mode is displayed.

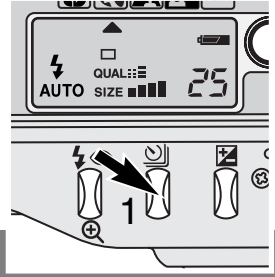

LCD Monitor	Data Panel		
		Single-frame advance	To take a single image each time the shutter-release button is pressed (p. 23).
		Self-timer/ Remote control	To delay the release of the shutter. Used for self-portraits.
		Continuous advance	To take multiple images when the shutter-release button is pressed and held.
		Bracketing	To take a series of three images with differing exposures.

All icons have been shown for clarity. The single-frame advance and continuous drive indicators occupy the same area of the data panel. All the drive-mode icons appear in the lower right corner of the monitor.

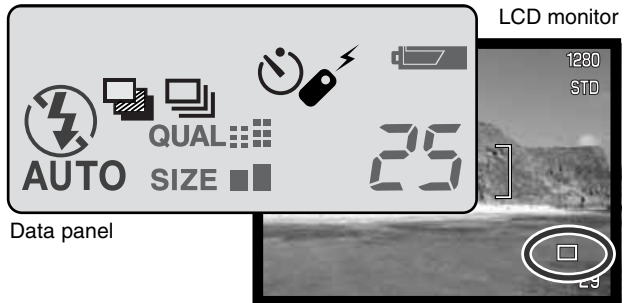

SELF-TIMER



Used for self-portraits, the self-timer will delay the release of the shutter for approximately ten seconds after the shutter-release button is pressed. The self-timer is set with the drive-mode button (p. 32).

With the camera on a tripod, compose the picture as described in the basic recording operation section (p. 23). Focus lock (p.24) can be used with off-center subjects. Press the shutter-release button partway down to lock the exposure and focus (1). Press the shutter-release button all the way down to begin the countdown (2). Because focus and exposure are determined when the shutter-release button is pressed, do not stand in front of the camera when taking a self-timer image. Always confirm the focus with the focus signals before beginning the countdown (p. 25).

During the countdown, the self-timer lamp on the front of the camera (3) will start to blink and is accompanied by an audio signal. A few seconds before the exposure, the self-timer lamp will blink rapidly. The lamp will glow steadily just before the shutter fires. To stop the countdown, press the drive-mode button. The audio signal can be turned off in the basic section of the setup menu (p. 84).

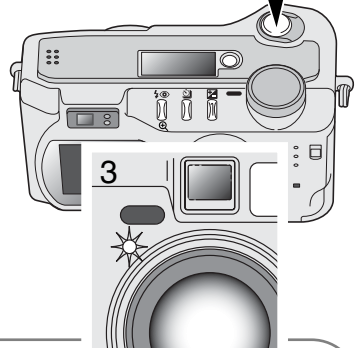
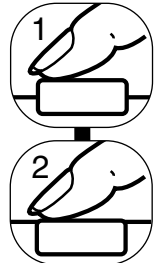

SHOOTING TIPS

The self-timer can be used to minimize camera shake with long exposures. When using the camera on a tripod, photographs of static subjects (landscapes, still-lives, or close-up photographs) can be made with the self-timer. Because no contact is made with the camera during exposure, there is no risk of camera shake caused by the operator.

AUTO-RECORDING MODE

REMOTE CONTROL (SOLD SEPARATELY)

The IR Remote Control RC-3 allows remote camera operation up to 5m (16 ft.) away. The remote control unit can be used in movie recording (p. 65).

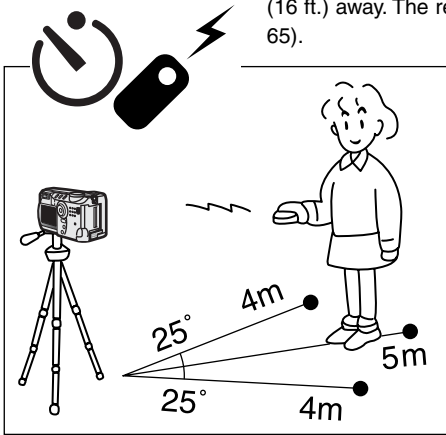

Place the camera on a tripod, and set the drive mode to self-timer / remote control (p. 32).

Arrange the camera and subject to compose the picture. Frame the subject within the focus frame when setting up the camera.

- Focus lock cannot be used with the IR remote control.
- In multi-function recording mode, focus area selection can be used for off-center subjects (p. 48).

Emitter window

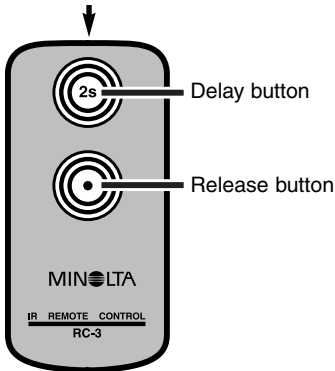

While pointing the emitter window of the remote control unit toward the camera, press the release button or the delay button to take the picture.

- When the release button is pressed, the self-timer lamp on the front of the camera will blink once before the picture is taken.
- When the delay button is pressed, the self-timer lamp on the front of the camera will blink for two seconds before the picture is taken.
- The remote control may not operate with backlit subjects or under fluorescent light.

CONTINUOUS ADVANCE



The continuous-advance drive mode allows a series of images to be captured while holding down the shutter-release button. Continuous advance acts like a motor drive on a film camera. The number of images that can be captured at one time and the rate of capture depend on the image-quality and image-size setting. The maximum rate of capture is 1.3 fps. The continuous-advance mode is set with the drive-mode button (p. 32).

When the shutter-release button is pressed and held, the camera will begin recording images until the maximum number has been taken or the shutter button is released. This mode cannot be used with super-fine images (p. 41). The built-in flash can be used, but the rate of capture is reduced because the flash must recharge between frames.

Compose the picture as described in the basic recording operation section (p. 23). Press the shutter-release button partway down to lock the exposure and focus for the series. Press and hold the shutter-release button all the way down (1) to begin taking pictures.

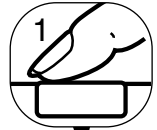

The following chart lists the maximum number of images that can be captured with different image-quality and image-size combinations.

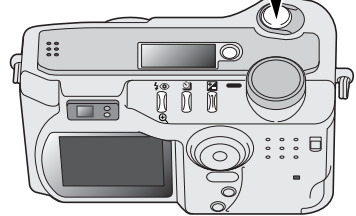

Image Quality \ Image Size	2272 X 1704	1600 X 1200	1280 X 960	640 X 480
Fine	7	12	17	38
Standard	10	18	26	53
Economy	16	28	36	66

AUTO-RECORDING MODE

BRACKETING

This mode makes a three-image bracket of a scene. Bracketing is a method of taking a series of images of a static subject in which each image has a slight variation in exposure. The bracketing mode is set with the drive-mode button (p. 32). Brackets cannot be made with super-fine images (p. 41).

The order of the bracket series is normal exposure (as indicated by the shutter speed and aperture displays), underexposure, and overexposure. The exposure bracket in auto-recording mode is set to 0.5 Ev increments. In multi-function recording mode the increment can be set to 0.3, 0.5, or 1.0 Ev increments (p. 50).

Compose the picture as described in the basic recording operation section (p. 23). Press the shutter-release button partway down (1) to lock the exposure and focus for the series. Press and hold the shutter-release button all the way down (2) to make the bracket series; three consecutive images will be captured. If the CompactFlash is filled or the shutter button is released before the series has completed, the camera will reset and the entire bracket must be made again. When using flash, there will be a delay between frames as the flash charges. The remaining number of frames in the bracket series is displayed on the monitor next to the bracketing icon.

When using exposure compensation (p. 46), the bracketing series will be made in relation to the compensated exposure. Under extreme conditions, one of the bracketed exposures may be inaccurate because it is outside the exposure control range of the camera.

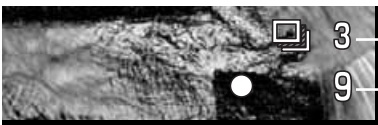
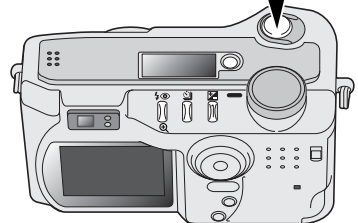
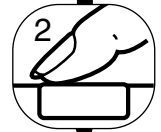
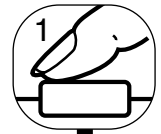
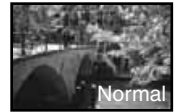

3 — Number of frames in bracketing series
9 — Frame counter

DISPLAY BUTTON - RECORDING MODE

The display-information button controls the LCD monitor display. The display cycles to the next position each time the button is pressed: full display, live image only, and monitor off.

Battery power can be conserved by turning the monitor off and using the viewfinder to take pictures. When the menu or exposure-compensation button is pressed, or the macro mode is activated, the monitor will automatically turn on. Full-time AF (p. 58) and the digital zoom are disabled when the monitor is off.

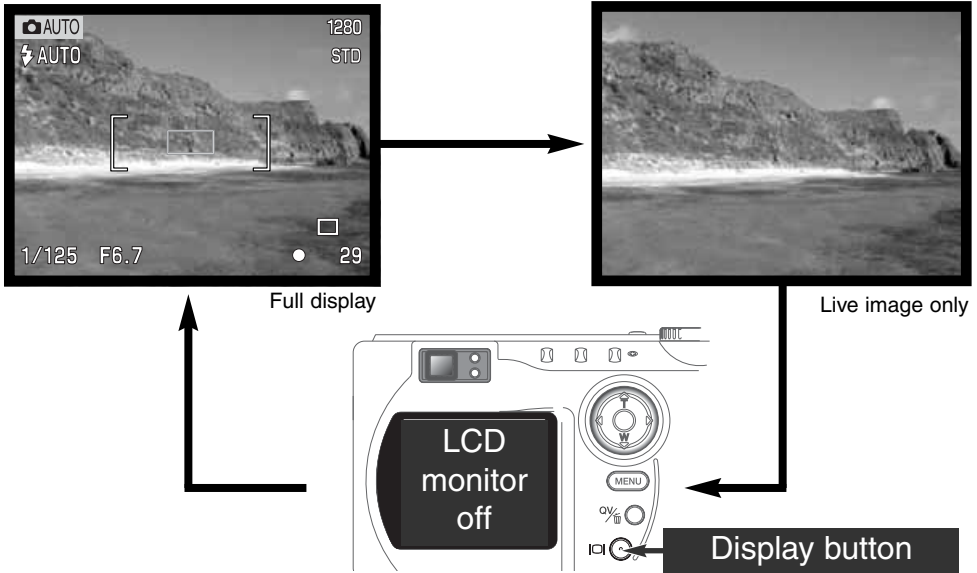

AUTO-RECORDING MODE

NAVIGATING THE AUTO-RECORDING MODE MENU

In auto-recording mode, press the menu button to activate the menu. The menu button also turns off the menu after settings are made. The four-way keys of the controller are used to move the cursor in the menu. Pressing the center of the controller will enter a setting.



Use the up/down keys of the controller (2) to scroll through the menu options. Highlight the option whose setting needs to be changed.

- When scrolling in one direction, the cursor will jump between the top and bottom of the menu.



With the menu option to be changed highlighted, press the right controller key; the settings will be displayed with the current setting highlighted.

- To return to the menu options, press the left key.



Use the up/down keys to highlight the new setting.



Press the center of the controller to select the highlighted setting.

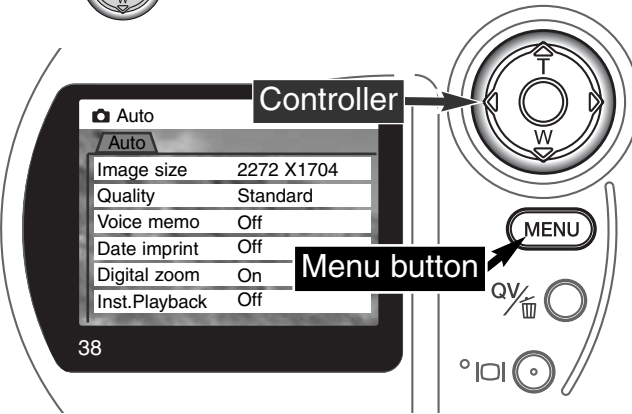

Once a setting has been selected, the cursor will return to the menu options and the new setting will be displayed. Changes can continue to be made. To return to the auto-recording mode, press the menu button.

Changes made on the auto-recording mode menu will also affect the multi-function recording mode.

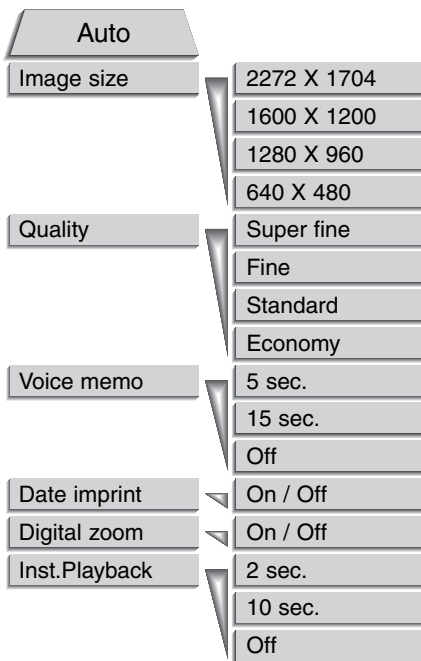

Settings made with the auto-recording menu will remain in effect until changed or the camera is reset to its default settings (p. 89).

Image size - To set the pixel resolution of the images. Image size affects the size of the image file.

Image quality - To set the rate of compression of the images. Image quality affects the size of the image file.

Voice memo - To record audio after a still image has been captured. The function can be turned off and the length of the recording can be set.

Date imprint - The date of recording can be imprinted on each image. The date is set in the custom 2 section of the setup menu (p. 84).

Digital zoom - The digital zoom can be turned off or on (p. 22).

Instant playback - After taking a picture, the image will be displayed on the monitor for two or ten seconds. The displayed image can be deleted before being saved to the CompactFlash card.

Read the following sections for more details on these options and settings. All of these functions appear on the multi-function recording mode menu.

AUTO-RECORDING MODE

IMAGE SIZE

Changing image size affects the number of pixels in each image. The greater the image size, the larger the file size. Choose image size based on the final use of the image - smaller images will be more suitable for web sites whereas larger sizes will produce higher quality prints.

Image size must be set before the picture is taken. Changes made to image size are displayed on the data panel and LCD monitor. Image size must be reset manually. See navigating the auto-recording mode menu section on page 38. In multi-function recording mode, image size is controlled in the basic section of the multi-function recording menu (p. 50).

If the image size is changed, the data panel will display the approximate number of images that can be recorded at that setting on the installed CompactFlash card. One CompactFlash card can contain images with differing sizes.

Data panel	LCD monitor	Number of pixels (hor. X vert.)	Image size
SIZE ■■■■	2272	2272 X 1704	FULL
SIZE ■■■	1600	1600 X 1200	UXGA
SIZE ■■	1280	1280 X 960	SXGA
SIZE ■	640	640 X 480	VGA

IMAGE QUALITY

This camera has four image quality settings: super fine, fine, standard, and economy. Always select the desired setting before taking the picture. See navigating the auto-recording mode menu section on page 38. In multi-function recording mode, image quality is controlled in the basic section of the multi-function recording menu (p. 50).

Image quality controls the rate of compression, but has no effect on the number of pixels in the image. The higher the image quality, the lower the rate of compression and the larger the file sizes. If the economical use of the CompactFlash card is important, use the economy mode. Standard image quality is sufficient for normal usage. The super-fine mode will produce the highest quality image and the largest image files. Depending on image size, when capturing super-fine images, a delay of up to fifty seconds can occur as the image is saved to the CompactFlash card; the monitors will be blank and the access lamp will glow during that period.

File formats vary with the image quality setting. Super fine images are saved as a TIFF file. The fine, standard, and economy settings are formatted as a JPEG file. Super fine, fine, standard, and economy files can be recorded as colour or monochrome images (p. 60) in the multi-function recording mode.

If the image quality is changed, the data panel will display the approximate number of images that can be recorded at that setting on the installed CompactFlash card. One CompactFlash card can contain images with differing qualities.

Data panel	LCD monitor		File type
QUAL ■■■■	S. FIN	Super fine - the highest quality image.	TIFF
QUAL ■■■	FINE	Fine - high quality image.	JPEG
QUAL ■■	STD	Standard - the default setting.	JPEG
QUAL ■	ECON	Economy - the smallest file sizes.	JPEG

AUTO-RECORDING MODE

IMAGE-FILE SIZE AND COMPACTFLASH CARD CAPACITY

The number of images that can be stored on a CompactFlash card is determined by the size of the card and the file size of the images. The actual file size is determined by the scene; some subjects can be compressed further than others.

Approximate file sizes.				
Image quality \ Image size	2272 X 1704	1600 X 1200	1280 X 960	640 X 480
Super fine	12MB	5.6MB	3.6MB	0.96MB
Fine	2MB	1.0MB	0.66MB	0.27MB
Standard	1MB	0.6MB	0.41MB	0.2MB
Economy	0.68MB	0.38MB	0.29MB	0.15MB
Approximate number of images that can be stored on a 16MB CompactFlash card.				
Super fine	1	2	4	15
Fine	7	14	21	48
Standard	12	23	33	65
Economy	20	36	46	79

CAMERA NOTES

The frame counter indicates the approximate number of images that can be stored on the CompactFlash card at the camera's image quality and size settings. If the settings are changed, the frame counter adjusts accordingly. Because the calculation is based on average file sizes, the actual image taken may not change the counter or may decrease it by more than one.

When the frame counter displays zero, it indicates no more images at the image size and quality settings can be captured. Changing the image size or quality settings may allow more image to be saved to the CompactFlash card.

The frame counter cannot exceed 999. When the number of recordable images exceeds this, 999 will be displayed. The frame counter will continue to count down when the number of recordable images falls below one thousand.

VOICE MEMO



Voice memo allows a five or fifteen second audio track to be recorded with a still image. The function is activated and the length of the recording time is set on the auto-recording mode menu (p. 38). In multi-function recording mode, voice memo is controlled in the custom 2 section of the multi-function recording menu (p. 50). When the function is active, the microphone icon is displayed on the data panel and LCD monitor. The voice memo must be set before taking a picture. It will remain in effect until reset.

After an image is captured, a screen will appear indicating the audio recording has started. A bar graph (1) will display the amount of recorded time remaining. The recording will automatically stop when the set time has elapsed. To cancel the recording and erase the audio track, press the down key of the controller (2) or the shutter-release button (3) before the recording has finished.

Voice memo is disabled when used with the continuous-advance or bracketing drive modes (p. 32). The voice memo cannot be played back in quick view; it can only be heard in the playback mode (p. 68). Images with voice-memo audio tracks have a note icon displayed with them.

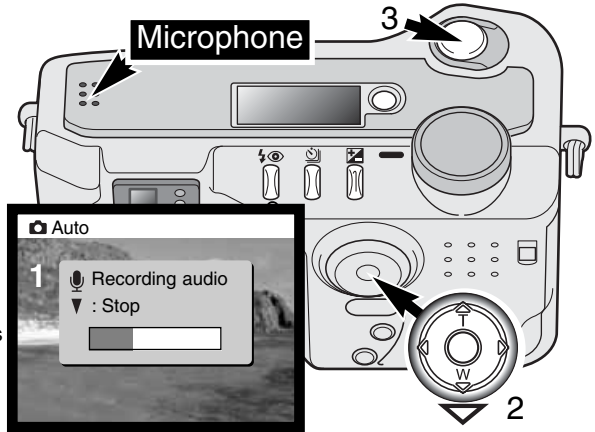

RECORDING TIPS

When making audio recordings, be careful not to touch or cover the microphone. The quality of the recording is proportional to the subject to microphone distance. For best results, hold the camera approximately 20cm (8in) from your mouth.

AUTO-RECORDING MODE

DATE IMPRINTING

The date of recording can be printed directly on the image. The imprinting function must be activated before the image is taken. Once activated, the date will continue to be imprinted until the function is reset; a yellow bar is displayed behind the frame counter on the monitor to indicate the imprinting function is active.

Date-imprinting indicator



Date imprinting is activated with a menu; see navigating the auto-recording mode menu section on page 38. In multi-function recording

mode, date imprinting is controlled in the custom 2 section of the multi-function recording menu (p. 50).

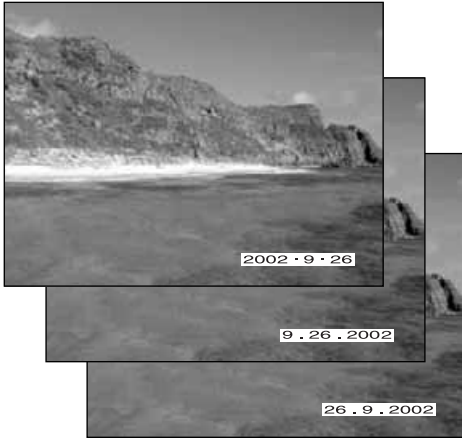

The date is imprinted in the lower right corner of the image when viewed horizontally. It is printed directly on the photograph writing over the image information. The date can be imprinted in three formats: year/month/day, month/day/year, and day/month/year. The date and date format are set in the custom 2 section of the setup-mode menu (p. 84).

Camera Notes

Every time a still image is recorded, it is stored with an exif tag that contains the date and time of recording as well as shooting information. This information can be viewed with the camera in the playback or quick-view mode, or on a computer with the DiIMAGE Image Viewer Utility software.

INSTANT PLAYBACK

After an image is captured, it can be displayed on the monitor before being saved. Instant playback is disabled when used with the continuous-advance or bracketing drive modes (p. 32).

Instant playback is activated with a menu; see navigating the auto-recording mode menu section on page 38. In multi-function recording mode, instant playback is set in the custom 2 section of the multi-function recording menu (p. 50). When used with voice memo, the audio recording will begin after the image is played back.

Menu setting	
Off	Instant playback is disabled.
2 sec	The captured image will be displayed for two or ten seconds. While displayed, the image can be deleted before being saved.
10 sec	



If the center of the controller is pressed during the instant playback, the displayed image will immediately be saved and the playback canceled.

- 1 To delete an image during the instant playback, press the QV/delete button.
 - A confirmation screen will appear.

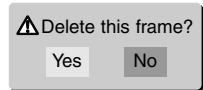

- 2 Use the left/right keys of the controller to highlight "YES."
 - "NO" will cancel the operation.



- 3 Press the controller to delete the image.
 - The live image will be displayed on the monitor.

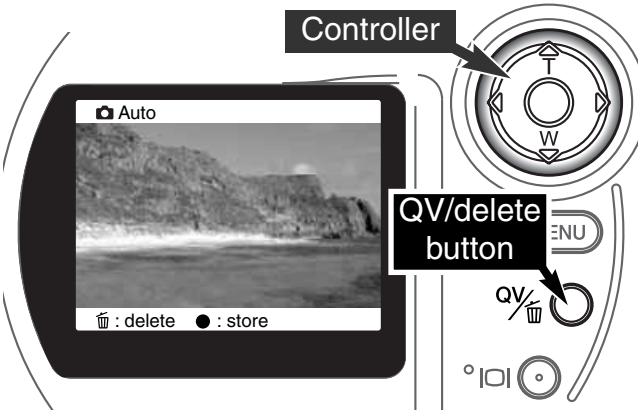

AUTO-RECORDING MODE

EXPOSURE COMPENSATION

The camera exposure can be adjusted to make the final picture lighter or darker by as much as $\pm 2\text{Ev}$ in $1/3$ increments. The exposure-compensation value will remain in effect until it has been reset. In auto-recording mode, exposure compensation is also reset when the mode dial is moved to another position.

The exposure compensation must be set before the image is captured. When setting the exposure compensation, the amount of compensation is shown next to the exposure-compensation icon on the monitor. After the setting is made, the shutter-speed and aperture displays will indicate the actual exposure. Because the exposure can be adjusted in fine steps, the shutter speed or aperture value displayed may not change. When set to any value other than 0.0, the exposure-compensation icon will remain on the data panel and LCD monitor as a warning.

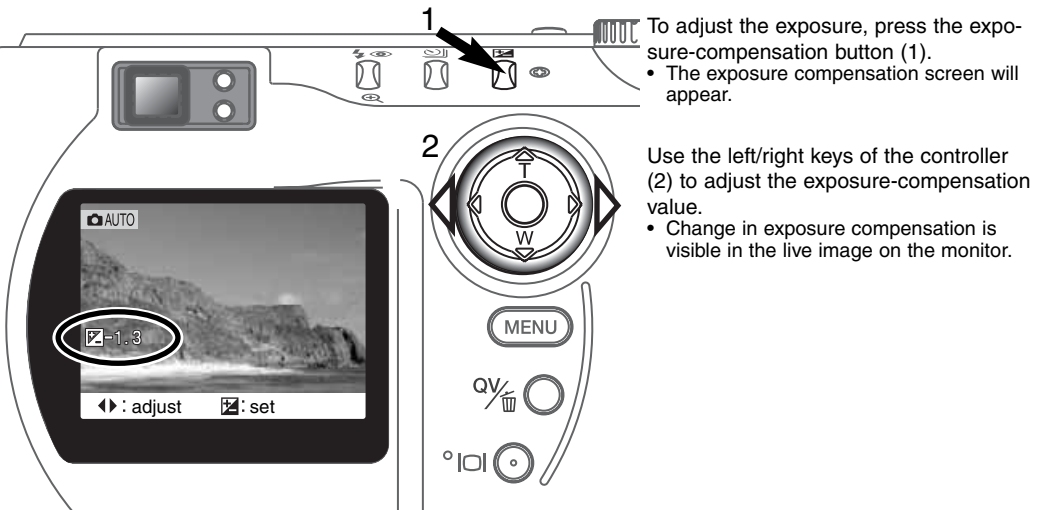

SHOOTING TIPS

Sometimes the camera's exposure meter is deceived by certain conditions. Exposure compensation can be used in these situations. For example, a very bright scene, such as a snowy landscape or a white sandy beach, can appear too dark in the captured image. Before taking the picture, adjusting the exposure by +1 or +2 EV will result in an image with normal tonal values.

In this example, the dark scene appears bright and washed-out on the LCD monitor. By decreasing the exposure by -1.5 EV, the richness of the sunset is preserved.

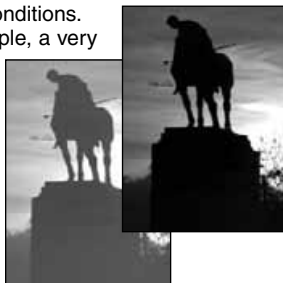

WHAT IS AN EV? WHAT IS A STOP?

Ev stands for exposure value. Stop refers to click stops in mechanical cameras. A change of one Ev or one stop will adjust the exposure calculated by the camera by a factor of two.

Change in Ev	Change in stops	Adjustment to exposure
+2.0 Ev	+2 stops	4X as much light
+1.0 Ev	+1 stop	2X as much light
0.0 Ev	Calculated exposure	
-1.0 Ev	-1 stop	1/2 as much light
-2.0 Ev	-2 stops	1/4 as much light

MULTI-FUNCTION RECORDING MODE ADVANCED OPERATION

Except for digital subject programs, the basic operation of the camera in multi-function recording mode is identical to the auto-recording mode. Thoroughly familiarize yourself with the previous section before moving on.

The multi-function recording mode allows greater control over image making. This recording mode gives more control over autofocus and composition. The menu controls are extensive allowing critical adjustments to image qualities such as sharpness, contrast, and colour saturation.

AUTOFOCUS AREAS AND CONTROL

In the multi-function recording mode, the controller selects the focus area used. The wide focus area and focus area selection allow flexibility in a variety of situations.

The wide focus area is an array of local focus areas that work together to control focus. This system is especially effective with moving subjects or quick shooting in fast-moving events. When the focus is locked, one of the AF sensors within the wide focus area will briefly indicate the point of focus.



Switching between the wide focus area and the spot focus areas is simple. Press and hold the controller (1) until the wide-focus-area frame lines change to the spot-focus-area display. Press and hold the controller again to return to the wide-focus-area frame lines.



The focus area selection controls which spot focus area is active. This function can be used for off-center subjects or to single out an individual subject from a group.

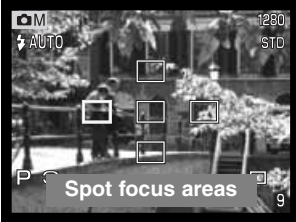

Press and hold the controller to display the spot focus areas; the active area is blue. Use the four-way key of the controller (2) to highlight the desired autofocus area.



Pressing the shutter-release button partway down (3) or pressing the center of the controller (4) will select the area; the other four areas will disappear.

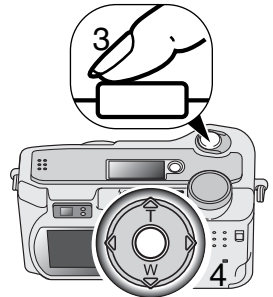

Once a spot focus area is selected, it will remain active even after the picture has been taken. Only when one focus area is displayed, can the controller be used to zoom (p. 22) or adjust the exposure (p. 52).

To select another focus area, press the center of the controller; all five areas should be displayed. The controller can now be used to change the spot focus area. Focus area selection will remain in effect when the LCD monitor is turned off.

MULTI-FUNCTION RECORDING

NAVIGATING THE MULTI-FUNCTION RECORDING MODE MENU

In multi-function recording mode, press the menu button to activate the menu. The menu button also turns off the menu after making settings. The four-way keys of the controller are used to move the cursor in the menu. Pressing the center of the controller will enter a setting.



Activate the recording-mode menu with the menu button. The “Basic” tab at the top of the menu will be highlighted. Use the left/right keys of the controller to highlight the appropriate menu tab; the menus will change as the tabs are highlighted.



When the desired menu section is displayed, use the up/down keys to scroll through the menu options. Highlight the option whose setting needs to be changed.

- When scrolling in one direction, the cursor will jump between the top and bottom of the menu.



With the menu option to be changed highlighted, press the right controller key; the settings will be displayed with the current setting highlighted.

- To return to the menu options, press the left key.



Use the up/down keys to highlight the new setting.



Press the controller to select the highlighted setting.

Controller

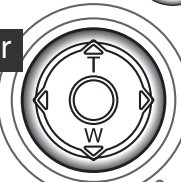

MENU

Menu button

Once a setting has been selected, the cursor will return to the menu options and the new setting will be displayed. Changes can continue to be made. To return to the recording mode, press the menu button. Changes made to image size, image quality, voice memo, date imprint, digital zoom, and instant playback will affect the auto-recording mode.

Multi		
Basic	Custom1	Custom2
Exposure mode	Program	
Image size	2272 X 1704	
Quality	Standard	
White balance	Auto	
Focus mode	AF	
Sensitivity	Auto	

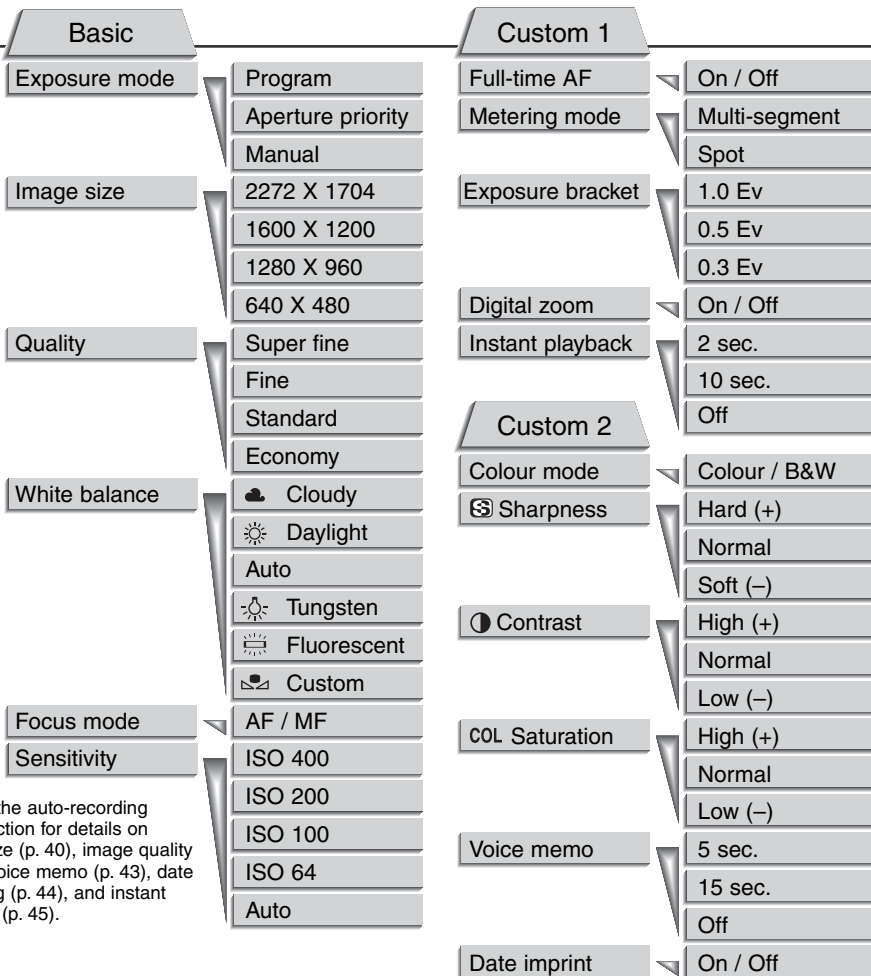

Refer to the auto-recording mode section for details on image size (p. 40), image quality (p. 41), voice memo (p. 43), date imprinting (p. 44), and instant playback (p. 45).

MULTI-FUNCTION RECORDING

EXPOSURE MODES

The three exposure modes allow extensive control over image making: program, aperture priority, and manual exposure. Exposure modes are set in the basic section of the multi-function recording mode menu (p. 50).

PROGRAM

The program exposure mode controls both the shutter speed and aperture to ensure perfect exposures. The sophisticated exposure system allows the photographer the freedom to shoot without having to worry about the technical details of exposure settings. The shutter speed and aperture values of the exposure are displayed on the monitor. If shutter speed and aperture displays turn red, the scene is beyond the exposure control range of the camera.

APERTURE PRIORITY - A

The photographer selects the aperture and the camera sets the appropriate shutter speed to ensure correct exposure. When aperture priority is selected, the aperture value on the monitor turns blue and a double arrow icon appears next to it. If the LCD monitor is turned off, the aperture value is fixed at the last setting and cannot be changed. The flash mode is set to flash cancel. Fill-flash can be selected (p.30).

Use the left/right keys of the controller (1) to set the desired aperture value. Press the shutter-release button to activate the exposure system; the corresponding shutter speed will be displayed on the monitor.

The aperture value can be changed in two steps: f/3.0 and f/6.7 at the lens' wide-angle position, f/3.6 and f/8.0 at the lens' telephoto position. As the lens is zoomed, the aperture will automatically shift. If the aperture value is beyond the shutter-speed range, the shutter-speed display will turn red on the monitor. For more on the aperture and image control, see page 62.



MANUAL EXPOSURE - M

Manual exposure mode allows individual selection of shutter speeds and apertures. This mode overrides the exposure system giving the photographer total control over the final exposure. The shutter speeds can be changed in half stop increments between 1/1000 and 4 seconds.



As changes are made to the exposure, the effect will be visible on the monitor. The shutter-speed and aperture display will turn red on the monitor if the image is extremely under or overexposed. If the monitor is black, increase the exposure until the image is visible; decrease the exposure if the monitor is white. If the LCD monitor is turned off, the exposure is fixed at the last setting and cannot be changed. When the shutter-release button is pressed partway down, the brightness of the live image may change while the camera is focusing.

In manual exposure mode, the auto camera-sensitivity setting will fix the ISO value at 100. The camera sensitivity can be changed in the basic section of the multi-function recording menu (p. 50). The flash mode is set to flash cancel. Fill-flash can be selected (p.30), but the live image will not reflect the ambient or flash exposure. Bulb exposures can be made, see page 61.

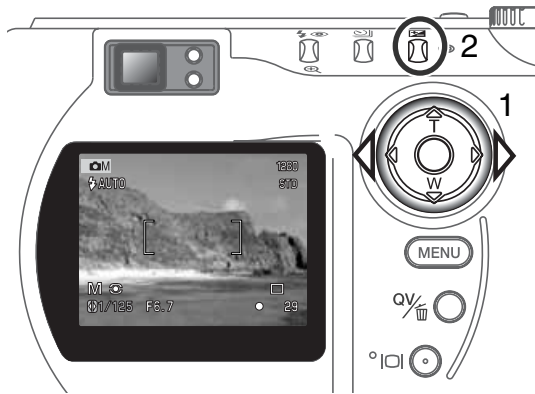

To set the shutter speed:

- Use the left/right keys of the controller (1) to set the desired shutter speed.

To set the aperture:

- Press the exposure-compensation button (2). The aperture value will turn blue.
- Use the left/right keys of the controller (1) to set the desired aperture.

The exposure-compensation button switches between the shutter speed and aperture display.

The value that can be set will be blue with a double arrow icon to the left of it.

MULTI-FUNCTION RECORDING

WHITE BALANCE

White balance is the camera's ability to make different types of lighting appear neutral. The effect is similar to selecting daylight or tungsten film, or using colour compensating filters in conventional photography.

An icon will be displayed on the monitor if a setting other than auto white-balance is chosen. White balance is set in the basic section of the multi-function recording mode menu (p. 50).





AUTOMATIC WHITE BALANCE

The automatic white balance compensates for the colour temperature of a scene. In most cases, the AUTO setting will balance the ambient light and create beautiful images, even under mixed-lighting conditions. When the built-in flash is used, the white balance is set for the colour temperature of the flash.

PRESET WHITE BALANCE

Preset white-balance settings must be set before the image is taken. Once set, the effect is immediately visible on the LCD monitor.

The built-in flash can be used with preset white-balance settings, but will create a pinkish or blueish cast with the fluorescent and tungsten settings. The flash is daylight balanced and will produce acceptable results with the daylight and cloudy settings.

	Cloudy	For overcast outdoor scenes.
	Daylight	For outdoor and sunlit subjects.
	Tungsten	For incandescent lighting: household filament light bulbs.
	Fluorescent	For fluorescent lighting: office ceiling lights.

CUSTOM WHITE BALANCE

Custom-white-balance function allows a photographer to calibrate the camera to a specific lighting condition. The setting can be used repeatedly until reset. Custom white balance is especially useful with mixed-lighting conditions or when critical control over colour is needed. The object used to make a calibration should be white. A blank piece of white paper is an ideal surface and can easily be carried in a camera bag. To calibrate the white balance for ambient light exposures, set the flash mode to flash-cancel (p. 30).

To calibrate the camera, select the custom setting in the white balance option in the basic section of the multi-function recording mode menu; a window will open asking you to choose “set” or “recall.” Use the controller to highlight “set” and then press the center of the controller to enter the command; the custom white-balance calibration screen will appear.

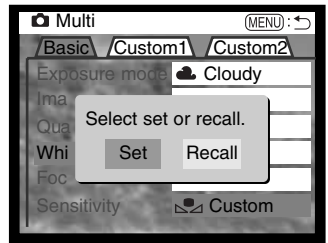

Fill the image area with a white object; the object does not need to be in focus. Press the shutter-release button to make the calibration. The custom setting will remain in effect until another calibration is made or the white-balance setting is changed.

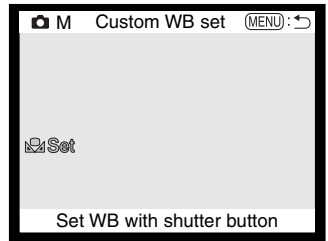

If the custom white-balance setting needs to be used again, select the custom setting on the basic section of the menu; a window will appear. Highlight “recall” and press the controller to enter the command; the last custom white-balance setting will be applied to the camera.

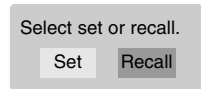

MULTI-FUNCTION RECORDING

FOCUS MODES

This camera has autofocus and manual focus control. The focus mode is set in the basic section of the multi-function recording mode menu (p. 50).

Autofocus will produce excellent results in almost every situation, however, under certain conditions, the autofocus system will not work accurately; see special focusing situations on page 25. In these situations the camera can be manually focused.

After setting the camera to the manual focus mode (MF), "ZOOM" and "FOCUS" will appear at the top of the LCD monitor. Press the center of the controller to switch between the two functions; the function highlighted in blue is active. With "FOCUS" highlighted, use the up/down keys of the controller to focus; the approximate focus distance is displayed at the bottom of the monitor next to the frame counter. All distances are measured from the CCD.

When the focus is set to the minimum focusing distance, as the lens is zoomed, the distance will change to match the minimum focusing distance at each focal length. Manual focus is not available when the monitor is turned off. The controller function will automatically switch to the zoom.

Press the controller to switch between focus and zoom (1). The active function is highlighted in blue (2).

Use the up/down keys of the controller to zoom or focus.

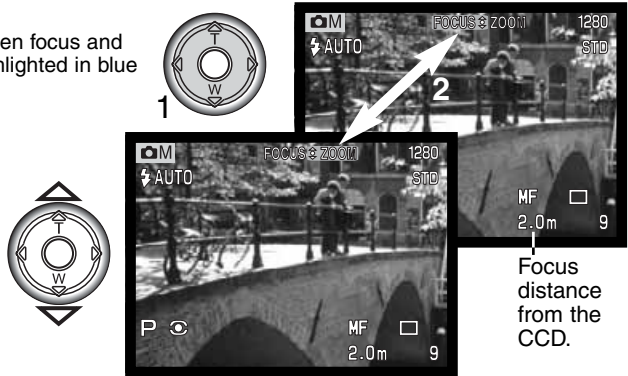

CAMERA SENSITIVITY - ISO

Five camera sensitivity settings can be selected: Auto, 64, 100, 200, and 400; the numerical values are based on an ISO equivalent. ISO is the standard used to indicate film sensitivity: the higher the number, the more sensitive the film. Camera sensitivity is set in the basic section of the multi-function recording mode menu (p. 50).

The auto setting automatically adjusts the camera sensitivity to the light conditions between ISO 64 and 320. When the flash is activated and camera sensitivity is set to auto, the ISO value is set between ISO 64 and 200. When any other setting than auto is used, "ISO" will appear on the data panel, and "ISO" and the set value will be displayed on the monitor.

Photographers can select a specific sensitivity setting. As the ISO value doubles, the camera sensitivity doubles. Like grain in silver-halide film that increases with speed, noise increases with sensitivity in digital imaging; an ISO setting of 64 will have the least noise and 400 will have the most noise. An ISO setting of 400 will allow the camera to be hand-held in low-light conditions without the need of a flash.

FLASH RANGE AND CAMERA SENSITIVITY

The flash range is measured from the CCD. Because of the optical system, the flash range is not the same at the lens' wide-angle position as it is at the telephoto position.

ISO setting	Flash range (wide angle)	Flash range (telephoto)
AUTO	0.5m ~ 3.5m (1.6 ft. ~ 11.5 ft.)	0.9m ~ 3.0m (3.0 ft. ~ 9.8 ft.)
64	0.5m ~ 2.0m (1.6 ft. ~ 6.6 ft.)	0.9m ~ 1.7m (3.0 ft. ~ 5.6 ft.)
100	0.5m ~ 2.5m (1.6 ft. ~ 8.2 ft.)	0.9m ~ 2.1m (3.0 ft. ~ 6.9 ft.)
200	0.5m ~ 3.5m (1.6 ft. ~ 11.5 ft.)	0.9m ~ 3.0m (3.0 ft. ~ 9.8 ft.)
400	0.5m ~ 5.0m (1.6 ft. ~ 16.4 ft.)	0.9m ~ 4.2m (3.0 ft. ~ 13.8 ft.)

At the wide-angle lens position, when using the flash with subjects closer than 1m (3ft), vignetting can occur. A slight shadow or shading may be apparent at the bottom of a horizontal image.

MULTI-FUNCTION RECORDING

FULL-TIME AF

With full-time AF active, the autofocus systems continually focuses to keep the monitor image sharp. This also reduces the autofocusing time when taking pictures. Full-time AF can be activated in the custom 1 section of the multi-function recording mode menu (p. 50).



When the monitor is turned off or when the camera is set to manual focus, full-time AF is disabled. Turning the full-time AF function off can help conserve battery power.

METERING MODES

The icons indicating both metering modes are displayed on the monitor only. The metering mode is set in the custom 1 section of the multi-function recording mode menu (p. 50).

Multi-segment metering uses 270 segments to measure luminance and colour. This data is combined with distance information to calculate the camera exposure. This advanced metering system will give accurate worry-free exposures in almost all situations.

Spot metering uses a small area within the image to calculate the exposure. When this mode is selected, the LCD monitor will automatically activate if off and a small circle will appear in the middle of the live image indicating the measuring area. The spot allows precise exposure measurements of a particular object without being influenced by extremely bright or dark areas within the scene. If the LCD monitor is turned off, the spot-metering mode will remain active.

LCD monitor	Data panel	
	-	Multi-segment
		Spot metering

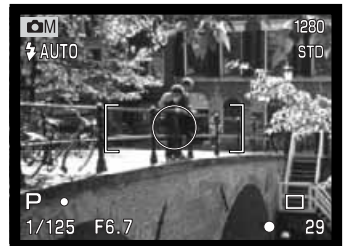

EXPOSURE BRACKETING

In multi-function recording mode, the bracketing increment can be changed in three steps: 0.3 Ev, 0.5 Ev, 1.0 Ev. The larger the number, the greater the difference in exposure between the images in the bracketed series. For information on the bracketing drive mode, see page 36. The bracketing increment can be changed in the custom 1 section of the multi-function recording mode menu (p. 50).

DIGITAL ZOOM AND IMAGE SIZE

The digital zoom doubles the lens magnification (p. 22). The digital zoom can be disabled in the custom 1 section of the multi-function recording mode menu (p. 50).

When an image is taken with the digital zoom, the final image size depends on the image-size setting on the camera. The image is trimmed and then the total number of pixels are recalculated to produce an image with a pixel resolution shown in the chart.

	Image size setting			
	2272 X 1704	1600 X 1200	1280 X 960	640 X 480
Size of recorded image	1024 X 768	1024 X 768	1024 X 768	640 X 480

MULTI-FUNCTION RECORDING

IMAGE CONTROL - COLOUR, SHARPNESS, CONTRAST, & SATURATION

Changes in colour, sharpness, contrast, and saturation can be made using the custom 2 section of the multi-function recording mode menu (p. 50). These imaging controls give photographers the ability to maximize the image information at the scene. For example, if a scene is too contrasty, information can be lost in the shadows and highlights; decreasing the contrast will bring out more detail.

Any changes made with these functions are applied to the live image on the monitor. The colour mode, sharpness, contrast, and colour saturation levels must be set before the image is recorded. If sharpness, contrast, or colour saturation is set to any setting other than normal, an icon will be displayed indicating an increase (+) or decrease (-) in the quality selected. Turning the camera off will not reset these functions; they must be manually reset using the menu.

Unlike the display on a computer, changes made with sharpness, contrast, and colour saturation may be difficult to see on the LCD monitor. However, when viewed with imaging software, the changes will be evident.



After compensation (-)

	Colour mode	To select between 24-bit colour and 8-bit monochrome images. It has no effect on image file size.
	Sharpness	To accent or soften details in an image in three levels: hard (+), normal, and soft (-).
	Contrast	To increase or decrease the contrast of the scene in three levels: high (+), normal, and low (-).
	Colour saturation	To accent or subdue the colour of a scene in three levels: high (+), normal, and low (-).

BULB EXPOSURES

Bulb photographs can be taken in the manual-exposure mode (M) (p. 53). Exposures up to fifteen seconds can be made by pressing and holding the shutter-release button. The use of a tripod is recommended for bulb exposures.

Set the exposure mode to manual in the basic section of the multi-function recording mode menu (p. 50). Set the drive mode to single-frame advance (p. 32).

Use the controller (1) to decrease the shutter-speed value below four seconds until “bulb” is displayed.



To set the aperture value, press the exposure-compensation button (2); the aperture display should turn blue. Use the controller (1) to set the aperture.

- The camera's exposure system cannot be used to calculate bulb exposures. The use of a separate light meter is recommended.

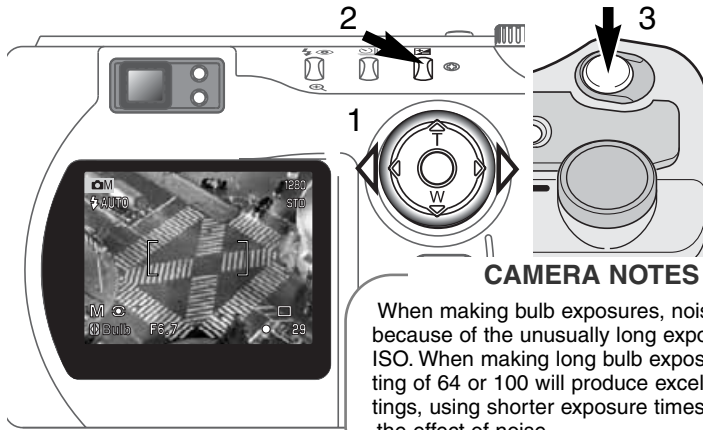

To take the picture, press and hold the shutter-release button (3) for the duration of the exposure.

- Releasing the shutter button will end the exposure.
- The monitors will be blank during the exposure.

CAMERA NOTES

When making bulb exposures, noise can be more pronounced because of the unusually long exposure times, especially at 400 ISO. When making long bulb exposures, a camera sensitivity setting of 64 or 100 will produce excellent results. At higher ISO settings, using shorter exposure times (8 seconds or less) will reduce the effect of noise.

A SHORT GUIDE TO PHOTOGRAPHY

Photography can be a rewarding pursuit. It is a broad and disciplined field that can take years to master. But the pleasure in making photographs and the joy of capturing a magical moment cannot be compared. This guide is an introduction to some basic photographic principles.

The lens aperture controls not only exposure, but also depth of field; the area between the closest object in focus and the furthest object in focus. The larger the aperture value, the greater the depth of field and the longer the shutter speed needed to make the exposure. The smaller the aperture value, the shallower the depth of field and the faster the shutter speed needed to make the exposure. Usually landscape photographs use a large depth of field (large aperture value) to keep the foreground and background in focus, and portraits use a shallow depth of field (small aperture value) to separate the subject from the background.



Depth of field also changes with focal length. The wide-angle position of the lens has a large depth of field; the telephoto position has a shallow depth of field.

The shutter controls not only exposure, but also the ability to stop motion. Fast shutter speeds are used in sport photography to stop action. Slow shutter speeds can be used to show the flow of motion such as water cascading over a waterfall. The use of a tripod is recommended with slow shutter speeds.



The change in aperture and shutter speed is not apparent in the live image. Unlike film cameras, test photographs can be taken and immediately viewed. For critical work, take a test photograph at the set aperture or shutter speed and view the result in quick view (p. 26). The image can be deleted if not acceptable and another test image can be taken at a different setting.

MOVIE RECORDING

This camera can record up to sixty seconds of digital video with sound. The motion JPEG image is 320 X 240 pixels (QVGA). The effective image area is 284 X 211 pixels; two thin lines will appear to the left and right of the image when played back. Under certain conditions less than sixty seconds of digital video may be recorded.

Total recording time with an 16MB CompactFlash card is approximately 52 seconds. The digital video recording rate is approximately 0.23MB per second. Actual CompactFlash card capacity depends on the subject and the number of still images captured.

In movie recording, some functions can be used, some are fixed, and some are disabled. Exposure compensation (p. 46) and macro mode (p. 28) can be used. The focus mode is set to AF; the autofocus area is set to wide; the exposure mode is set to program; camera sensitivity and white balance is set to auto. The flash and digital zoom is disabled. This mode has no menu controls.



Before recording, the data-panel and monitor frame counters will show the maximum time in seconds can be recorded with the next movie clip. A maximum of 60 seconds will be displayed until the amount of remaining time falls below one minute, then the remaining number of seconds that can be recorded will be displayed.

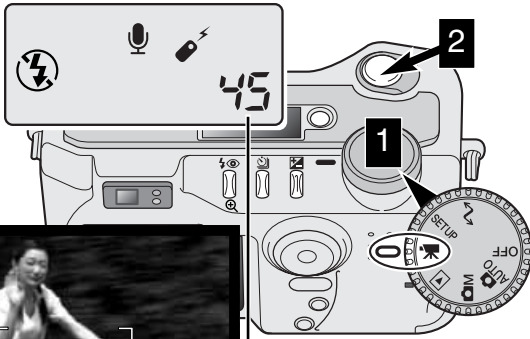

Shooting digital video is simple. Set the main dial to movie recording (1). Frame the picture as described in the basic recording operation section (p. 23). Press the shutter-release button partway down to lock the focus. Press the shutter-release button all the way down and release to start recording (2). The zoom and focus are fixed during recording. The camera will continue to record until the recording time is used or the shutter-release button is pressed again. When recording, the data panel and monitor frame counters will count down the remaining time.



●REC
45s

Recording indicator
Countdown in seconds

RECORDING MOVIES WITH THE RC-3 REMOTE CONTROL

The RC-3 remote control (sold separately) can be used to record movie clips up to 5m (16ft) away. Simply point the remote control toward the camera and use the release or delay button to start and stop the recording.

When using the release button (1), the self-time lamp will blink once before the camera starts to record; when using the delay button (2), the self-timer lamp will blink for two seconds before recording. The lamp will glow to indicate the camera is recording. Both buttons will stop the camera instantly when pressed. The remote control may not operate with backlit subjects or under fluorescent light.

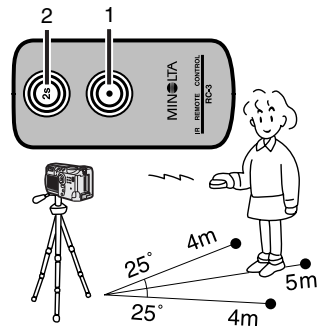

PLAYBACK MODE

VIEWING AND EDITING IMAGES

This section contains detailed information on the camera's playback functions and operation. Read the sections pertaining to your interest and need. The viewing pictures, viewing movies, deleting images (p. 68 - 69), the navigating the playback-mode menu (p. 72), and frame-selection screen (p. 81) sections cover the use of most of the features for viewing and editing images. The navigating the playback-mode menu section is followed by detailed descriptions of the settings.

SINGLE-FRAME PLAYBACK DISPLAY

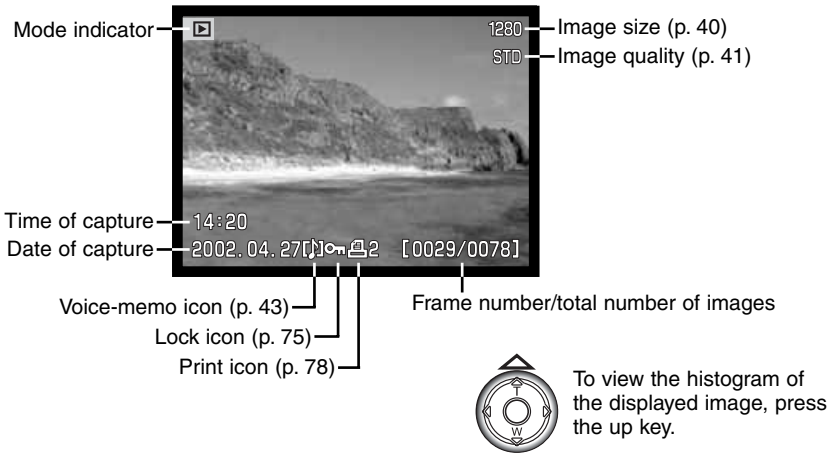

HISTOGRAM DISPLAY

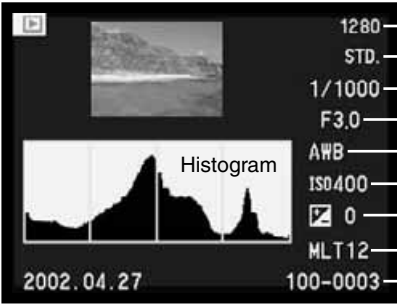

- 1280 — Image size (p. 40)
- STD. — Image quality (p. 41)
- 1/1000 — Shutter speed
- F3.0 — Aperture value
- AWB — White-balance setting (p. 54)
- ISO400 — Camera sensitivity setting (p. 57)
- ☑ 0 — Degree of exposure compensation (p. 46)
- MLT12 — Folder name (p. 100)
- 100-0003 — Folder number - image file number



To return to single-frame playback, press the down key.

The histogram shows the luminance distribution of the recorded image from black (left) to white (right). Each one of the 256 vertical lines indicates the relative proportion of that light value in the image. The histogram can be used to evaluate exposure, but displays no colour information.

MOVIE PLAYBACK DISPLAY

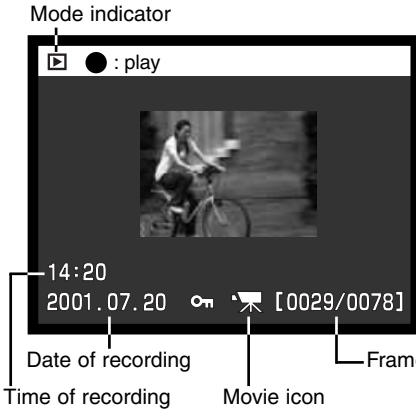

To view the movie, press the controller.

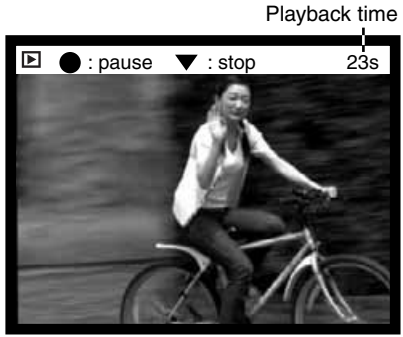

- 14:20 — Time of recording
- 2001.07.20 — Date of recording
- [0029/0078] — Frame number/ total number of images in folder
- Movie icon
- 23s — Playback time

PLAYBACK MODE

VIEWING PICTURES

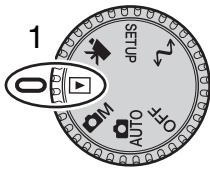

Still images and movie clips can easily be viewed and edited in playback mode. To set the camera to view images, turn the mode dial to the playback position (1).

Simply use the controller to scroll through the pictures on the CompactFlash card. The date and time of capture, frame number, printing status, lock status, image size and image quality are displayed with the images. The histogram and shooting data of a still image can also be displayed. The first frame of each movie clip is shown; a movie clip is indicated by the movie icon displayed with a thumbnail of the first frame.



Use the left/right keys of the controller to scroll through the images.



Press the up key to display the histogram of a still image.

- The left/right keys are disabled when the histogram is displayed. Press the down key to return to the playback mode.

Controller



To play back a voice memo accompanying a still image, press the center of the controller.

- A note icon indicates if the image has an audio track.
- To cancel the audio playback, press the down key.



QV/delete button



MENU

VIEWING MOVIES



Use the left/right keys of the controller to display the movie clip to be viewed.



- Press the center of the controller to play back the clip.
- Pressing the controller during playback will pause the movie clip; pressing the controller again will resume the playback. When the movie clip finishes, the first frame will be displayed.
 - Press the display button to view the movie with or without the guidance bar.



To cancel the playback of a movie, press the down key of the controller.

DELETING IMAGES

In playback mode, the displayed image or movie clip can be deleted. When selecting an image for deletion, a confirmation screen will appear before the operation is executed.

Once deleted, an image cannot be recovered.
Care should always be taken when deleting images.



- To delete a displayed image, press the QV/delete button.
- A confirmation screen will appear.



Confirmation screen



- Use the left/right keys to highlight "YES."
- "NO" will cancel the operation.



Press the controller to delete the image.

PLAYBACK MODE

DISPLAY BUTTON - PLAYBACK MODE

The display button controls the display format. Each time the button is pressed, the display cycles through to the next format: full display, image only, index playback.

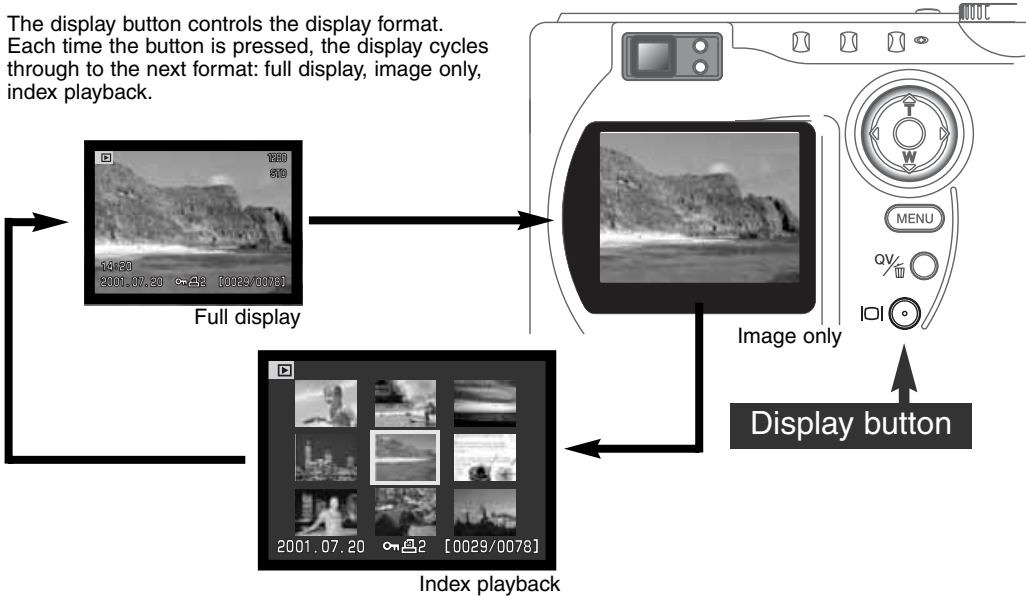

In index playback, the left/right keys of the controller will move the yellow border to the next or the previous image. When the image is highlighted with the border, the date of recording, voice memo icon, the lock and printing status, and the frame number of the image are displayed at the bottom of the screen. The highlighted image can be deleted using the QV/delete button (p. 69), or an accompanying voice memo can be played by pressing the controller. When the display information button is pressed again, the highlighted image will be displayed in the single-frame playback mode. A nine or four image index can be displayed. The index-playback format can be changed in the basic section of the playback-mode menu (p. 72).

ENLARGED PLAYBACK

In single-frame playback, a still image can be enlarged for closer examination in three steps: 2X, 2.5X, and 3.5X. 640 X 480 size images can only be enlarged one step to 2X. The maximum enlargement of 1024 X 768 digital zoom images is 3.2X. Super fine images cannot be enlarged.

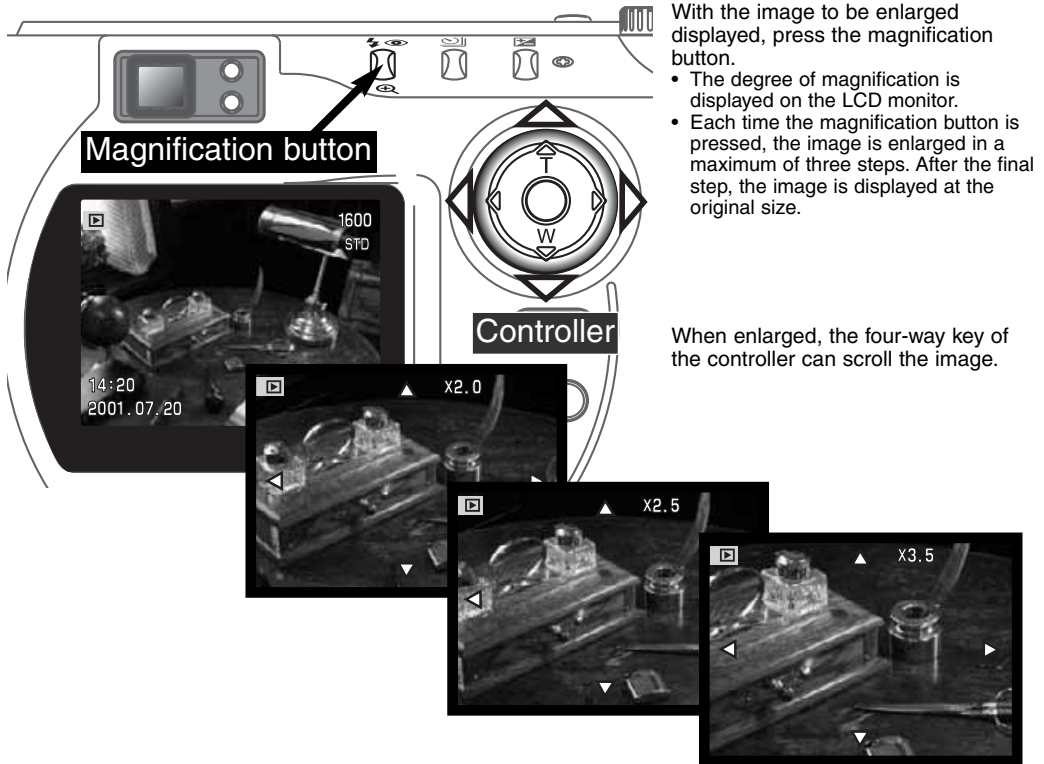

PLAYBACK MODE

NAVIGATING THE PLAYBACK-MODE MENU

In playback mode, press the menu button to activate the menu. The menu button also turns off the menu after making settings. The four-way keys of the controller are used to move the cursor in the menu. Pressing the center of the controller will enter a setting.



Activate the playback-mode menu with the menu button. The "Basic" tab at the top of the menu will be highlighted. Use the left/right keys of the controller to highlight the appropriate menu tab; the menus will change as the tabs are highlighted.



When the desired menu section is displayed, use the up/down keys to scroll through the menu options. Highlight the option whose setting needs to be changed.

- When scrolling in one direction, the cursor will jump between the top and bottom of the menu.



With the menu option to be changed highlighted, press the right controller key; the settings will be displayed with the current setting highlighted.

- To return to the menu options, press the left key.



Use the up/down keys to highlight the new setting.



Press the controller to select the highlighted setting.

Controller



MENU

Menu button

Once a setting has been selected, the cursor will return to the menu options and the new setting will be displayed. Changes can continue to be made. To return to the playback mode, press the menu button.

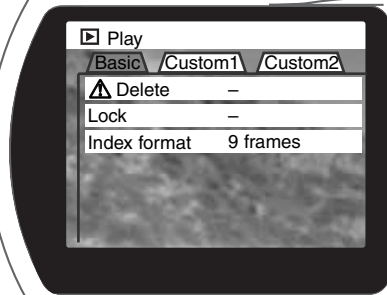

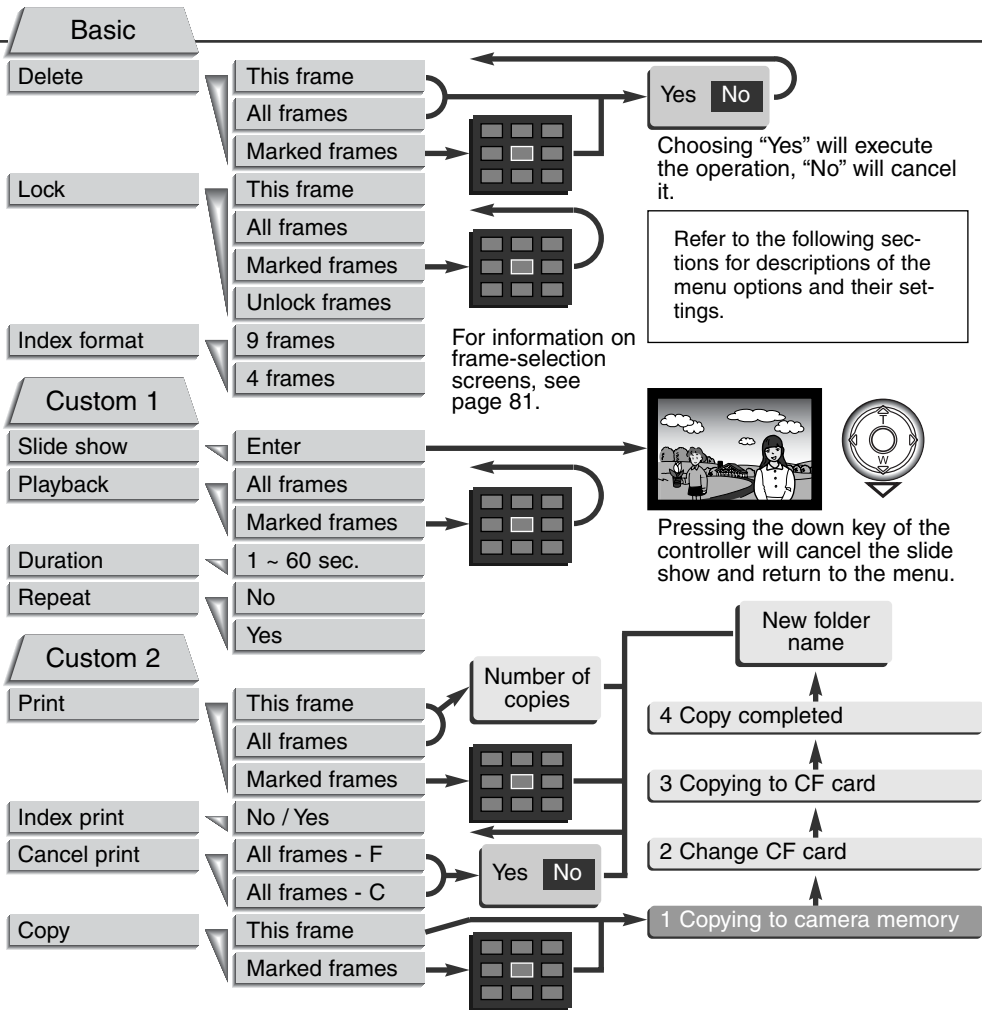

PLAYBACK MODE

PLAYBACK-MODE MENU - BASIC

DELETING IMAGES

Deleting permanently erases the image. Once deleted, an image cannot be recovered. Care should be taken when deleting images.

Single, multiple, or all images in a folder can be deleted with the playback-mode menu. Before an image is deleted, a confirmation screen will appear; choosing “Yes” will execute the operation, “No” will cancel the operation. To delete images in other folders, the folder must first be selected in the custom 1 section of the setup menu (p. 84). The delete option has three settings:

This frame - The image displayed or highlighted in playback mode will be deleted.

All frames - All unlocked images in the selected folder will be deleted.

Marked frames - To delete multiple images. When this setting is chosen, the frame-selection screen will be displayed. Use the left/right keys of the controller to highlight the first image to be deleted. Pressing the up key will mark the image with the garbage-can icon. To deselect an image for deletion, highlight it with the yellow border and press the down key; the garbage-can icon will disappear. Continue until all the images to be deleted are marked. Press the controller to continue (the confirmation screen will appear), or press the menu button to cancel the operation and return to the playback menu. On the confirmation screen, highlighting and entering “Yes” will delete the marked images.

The delete function will only erase unlocked images. If an image is locked, it must be unlocked before it can be deleted.

LOCKING IMAGES

Single, multiple, or all images in a folder can be locked. A locked image cannot be deleted by either the playback-mode menu functions or the QV/delete button. Important images should be locked. To lock images in other folders, the folder must first be selected in the custom 1 section of the setup menu (p. 84). The lock option has four settings:

This frame - The image displayed or highlighted in playback mode will be locked.

All frames - All images in the folder will be locked.

Marked frames - To lock or unlock multiple images. When this setting is chosen, the frame-selection screen will be displayed. Use the left/right keys of the controller to highlight the image to be locked. Pressing the up key will mark the image with the key icon. To unlock an image, highlight it with the yellow border and press the down key; the key icon will disappear. Continue until all the images to be locked are marked. Press the controller to lock the marked frames, or press the menu button to cancel the operation and return to the playback menu.

Unlock frames - All images in the folder will be unlocked.

Locking an image will protect it from a delete function. However, the formatting function (p. 86) will erase all images on a CompactFlash card whether locked or not.

CHANGING THE INDEX PLAYBACK FORMAT

The index format option allows the index playback to be displayed with four or nine images. This affects all index displays.

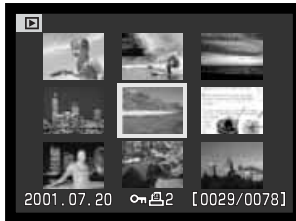

PLAYBACK MODE

PLAYBACK-MODE MENU - CUSTOM 1 (SLIDE SHOW)

The custom 1 section of the playback-mode menu controls the slide-show function. This function automatically displays all still images in a folder in order.



Frame count-down / total number of images in the presentation.



Press the controller to pause and restart the presentation.



To cancel the presentation, press the down key of the controller.

Menu options	Settings	
Slide show	Enter	To start the slide-show presentation. Pressing the center of the controller will pause the presentation. During the slide show, press the down key of the controller to stop the presentation and return to the playback-mode menu.
Playback	All frames	To select all the images in the folder to be displayed in the slide-show presentation.
	Marked Frames	To select specific images in the folder to be displayed in the slide-show presentation. When this setting is chosen, the frame-selection screen will be displayed. Use the left/right keys of the controller to highlight the image to be included in the presentation. Pressing the up key will mark the image with a check icon. To deselect a marked image, highlight it with the yellow border and press the down key; the check icon will disappear. Continue until all the images have been edited. Press the controller to set the marked frames, or press the menu button to cancel the operation and return to the playback menu.
Duration	1 - 60s.	To select the period each image will be displayed during the slide show.
Repeat	Yes / No	Selecting “Yes” will cause the slide show to repeat until it is canceled using the down key of the controller. “No” will end the slide show presentation and return to the playback-mode menu when all the images have been displayed once.

PLAYBACK MODE

PLAYBACK-MODE MENU - CUSTOM 2

ABOUT DPOF

This camera is supported by DPOF™ version 1.1. The DPOF (Digital Print Order Format) allows direct printing of still images from digital cameras. After the DPOF file is created, the CompactFlash card is simply taken to a photofinishing service or inserted into the CompactFlash-card slot of DPOF compatible printers. When a DPOF file is created, a misc. folder is automatically made on the CompactFlash card to store it (p. 100).

CREATING A DPOF PRINT ORDER

The print menu option is used to set an order for standard prints from images in a specific folder. Single, multiple, or all images can be printed. If a CompactFlash card has multiple folders, a printing file must be created for each folder. Folders are selected in the custom 1 section of the setup menu (p. 84).

This-frame - To create a DPOF file for the image displayed or highlighted in playback mode.

All-frames - To create a DPOF file for all images in the folder specified in the custom 1 section of the setup menu (p. 84).

Marked frames - To chose a group of images to be printed or when the number of copies for each image varies. When selected, the frame selection screen will appear. Use the left/right keys of the controller to highlight an image to be printed. Pressing the up key will mark the image with the printer icon. The number next to the icon indicates the number of copies of that image will be printed. Pressing the up key will increase the number of copies, pressing the down key will decrease the number. A maximum of nine copies can be ordered. To deselect an image for printing, press the down key until the the number of copies reaches zero and the printer icon disappears. Continue until all the images to be printed are marked. Press the controller to create the DPOF file, or press the menu button to cancel the operation and return to the playback menu.

When the this-frame or all-frames setting is chosen, a screen will appear requesting the number of copies of each image; a maximum of nine copies can be ordered. Use the up/down keys of the controller to set the number of copies desired. If the all-frames setting was used to create a print order, any additional images saved afterwards in the folder will not be included in the order.

DPOF files cannot be created for images captured with another camera. DPOF data created on other cameras will not be recognized.

ORDERING AN INDEX PRINT

To create an index print of all the images in the folder, select “Yes.” To cancel an index print, simply change the setting to “No.” If an index-print order is created, any additional images saved afterwards in the folder will not be included in the index print. The number of images printed per sheet differs between printers. The information printed with the thumbnails can vary.



CANCELING A DPOF PRINT ORDER

The cancel-print option deletes the DPOF files. When the setting is selected, a confirmation screen will appear; choosing and entering “Yes” will execute the operation and cancel the print order. After the pictures have been printed, the DPOF file will still remain on the CompactFlash card and must be canceled manually.

All frames C - To cancel all printing files on the CompactFlash card.

All frames F - To cancel the printing file in the folder. Folders are selected in the custom 1 section of the setup menu (p. 84).

PLAYBACK MODE

COPYING IMAGES

Image files can be copied from one CompactFlash card to another. Up to 23MB of data can be transferred. Every time the copy function is used, a new folder is automatically created for the images (p. 100). Images with voice memos are copied with their audio files. Copies of locked images are unlocked (p. 75). DPOF information is not copied.

This frame - To copy the image displayed or highlighted in playback mode.

Marked frames - To copy single or multiple images. When selected, the frame-selection screen will appear; highlight the image to be copied with the yellow border and then press the up key of the controller to mark it with the check icon. To deselect an image to be copied, highlight the selected image and press the down key; the check icon will disappear. Continue until all the images to be copied are marked. Press the controller to continue, or press the menu button to cancel the operation and return to the playback menu.

When the image(s) to be copied are selected, a screen with four messages is displayed; the messages are highlighted during the copying procedure. When the change-CF-card message is highlighted, remove the camera's CompactFlash card and insert the card to which the image should be copied. Press the center of the controller to continue or the menu button to cancel the copy operation. After the copy-completed message is highlighted, a new screen will appear to indicate the name of the new folder containing the copied images; press the controller to return to the menu.

If too many images have been selected, a warning will appear and the copy routine will be canceled. Divide the number of images into two or three batches. The copy-unsuccessful message will appear when one or all of the images could not be copied. Check the second CompactFlash card to see which files were copied and then repeat the procedure for the images that were not transferred.

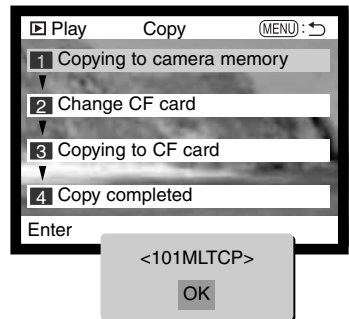

FRAME-SELECTION SCREEN

When a marked-frames setting is chosen on a menu, the frame selection screen will appear. This screen allows multiple images to be chosen. The index format of the screen can be changed in the basic section of the playback-mode menu (p. 72).





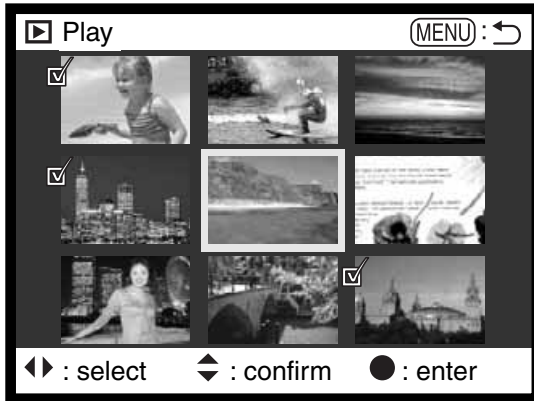

The left/right keys of the controller move the yellow border to select the image.

Menu button Cancels the screen and any operation made.



The up key of the controller selects the frame; when selected, an icon will appear next to the image. The down key will deselect the image removing the icon.

	<p>The garbage-can icon indicates the image is selected for deletion.</p>
	<p>The key icon indicates the image is locked or selected to be locked.</p>
	<p>The check icon indicates the image is selected for the slide show or to be copied to another CompactFlash card.</p>
	<p>The printer icon indicates the image is selected for printing. The number next to the icon shows the number of copies requested.</p>

PLAYBACK MODE

VIEWING IMAGES ON A TELEVISION

It is possible to view camera images on your television. The camera has a video-out terminal to make the connection using the supplied AV cable. The camera is compatible with the NTSC and PAL standards. The video-output setting can be checked and set in the custom 2 section of the setup menu (p. 84).

1. Turn off the television and the camera.
2. Insert the mini-plug end of the AV cable into the camera's video-out terminal.
3. Plug the other end of the AV cable into the video and audio input terminals on the television.
 - The yellow plug is for the video output. The white plug is for the monaural audio output.
 - The audio output will also be heard through the camera's speaker while connected to a television.
4. Turn the television on.
5. Change the television to the video channel.
6. Turn the camera's mode dial to the playback position.
 - The camera's monitors will not activate when the camera is attached to a television. The playback-mode display will be visible on the television screen.
7. View images as described in the playback section.

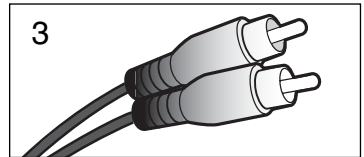
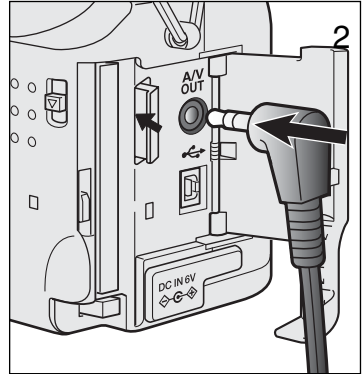

SETUP MODE

CONTROLLING THE CAMERA'S OPERATION

The setup mode is used to control the camera's functions and operation as well as to select image folders. The navigating the setup menu section (p. 84) covers the operation of the menu. The section is followed by detailed descriptions of the settings.

MINOLTA HISTORY



Innovation and creativity has always been a driving force behind Minolta products. The Electro-zoom X was purely an exercise in camera design. It was unveiled at Photokina in Germany in 1966.

The Electro-zoom X was an electronically controlled aperture-priority mechanical SLR with a built-in 30 - 120mm f/3.5 zoom lens giving twenty 12 X 17mm images on a roll of 16mm film. The shutter-release button and battery chamber are located in the grip. Only a few prototypes were built making it one of Minolta's rarest cameras.

SETUP MODE

NAVIGATING THE SETUP MENU

To access the menu, simply turn the mode dial to the setup position. The four-way keys of the controller are used to move the cursor in the menu. Pressing the controller will enter a setting.



When the menu activates, the “Basic” tab at the top of the menu will be highlighted. Use the left/right keys of the controller to highlight the appropriate menu tab; the menus will change as the tabs are highlighted.



When the desired menu section is displayed, use the up/down keys to scroll through the menu options. Highlight the option whose setting needs to be changed.

- When scrolling in one direction, the cursor will jump between the top and bottom of the menu.



With the menu option to be changed highlighted, press the right controller key; the settings will be displayed with the current setting highlighted.

- To return to the menu options, press the left key.



Use the up/down keys to highlight the new setting.



Press the controller to select the highlighted setting.

Controller

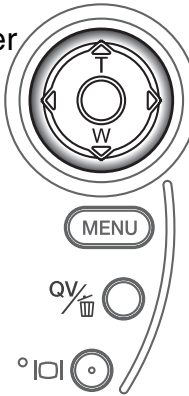

Once a setting has been selected, the cursor will return to the menu options and the new setting will be displayed. Setting can continue to be made.

Setup

Basic / Custom1 / Custom2

LCDbrightness 3

▲ Format -

Power save 1 min

Audio signals On

Language English

Basic

LCDbrightness	1 (low) ~ 5 (high)
Format	Enter
Power Save	1, 3, 5, or 10 min
Audio signals	Off w/o sound FX Sound FX only On
Volume	1 (low) ~ 3 (high)
Language	Japanese English Deutsch Français Español

Yes No

Choosing "Yes" on the confirmation screens will execute the operation, "No" will cancel the operation.

Please refer to the following sections for descriptions of the menu options and their settings.

On the date/time setting screen, use the left/right key of the controller to select the year, month, day, hour, or minute. The up/down key is used to change the value. Press the controller to set the calendar and clock.

Custom 1

File # memory	On / Off
Select folder	(Folder names)

Custom 2

Reset default	Enter
Date/Time set	Enter
Date format	YYYY/MM/DD MM/DD/YYYY DD/MM/YYYY
Video output	NTSC PAL

Yes No

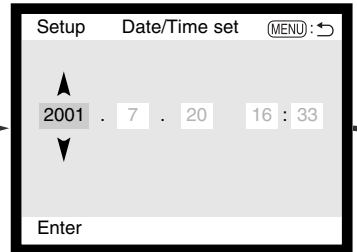

SETUP MODE

SETUP MENU - BASIC

The basic section of the setup menu allows changes to be made to the operation of the camera as well as the ability to format CompactFlash cards.

LCD MONITOR BRIGHTNESS

The brightness of the LCD monitor can be set in five levels from 1 (low) to 5 (high). As each setting is highlighted, the monitor will adjust accordingly; the controller must be pressed to set the highlighted level.

FORMATTING COMPACTFLASH CARDS

When a CompactFlash card is formatted, all data on the card is erased.

The formatting function is used to erase all data on a CompactFlash card. Before formatting a CompactFlash card, copy the data to a computer or storage device. Locking images will not protect them from being deleted when the card is formatted. Always format the CompactFlash card using the camera; never use a computer to format a card.

When the format option is selected and entered, a confirmation screen will appear. Choosing "Yes" will format the card, choosing "No" will cancel the formatting operation. A screen will appear to indicate the card has been formatted; press "OK" to return to the setup menu.

If the card-not-recognized message appears, the inserted card in the camera may need to be formatted. A CompactFlash card used in another camera may have to be formatted before being used. If the unable-to-use-card message appears, the card is not compatible with the camera and cannot be formatted.

AUTO POWER SAVE

The camera will turn off the data panel to conserve battery power if no operation is made within a certain period. The length of this period can be changed to 1, 3, 5, or 10 minutes. The auto-power-save option will not affect the display period of LCD monitor; it will shut down after 30 seconds. To restore the displays when they shut down, simply press the shutter-release button.

When the camera is connected to the computer, the auto-power-save period is set to ten minutes. This period cannot be changed.

AUDIO SIGNALS

The audio signal can be turned off or on. When on, both tones signals and sound effects are used. The sound effects simulates a film camera when the shutter is released. The sound effects and tones can be turned off independantly of each other.

Menu setting	
Off	All audio signals are turned off.
w/o sound FX	Tone signals only to indicate camera opertations.
Sound FX only	Shutter effect only. No tone signals during operation.
On	Shutter effect and tone signals.

VOLUME

The speaker volume can be increased or decreased. This affects the audio signals only and will not change the levels of the voice memo or movie audio track.

LANGUAGE

The language used in the menus can be changed.

SETUP MODE

SETUP MENU - CUSTOM 1

The custom 1 section of the setup menu controls file number sequencing and the selection of folders. See page 100 for information on the organization of the folders on the CompactFlash card

FILE NUMBER (#) MEMORY

When file number memory is selected, if a new folder is created, the first file stored in the folder will have a number one greater than the last file saved. If the file number memory is disabled, the image file name will have a number one greater than the last image saved in the folder.

If file number memory is active and the CompactFlash card is changed, the first file saved to the new card will have a number one greater than the last file saved on the previous card if the new card does not contain an image with a greater file number. If it does, the file number of the new image will be one greater than the greatest on the card.

SELECT FOLDER

This option allows the selection of existing folders. After folder is selected, all images recorded will be placed in that folder. In quick view or playback mode, only the images in the selected folder can be viewed or edited.

Except for the all-frames-C setting in the custom 2 section of the playback-mode menu, changes made with menus only affect the images in the selected folder. To make changes to all images in multiple folders, each folder must be selected and the menu operation repeated for each folder. Formatting a CompactFlash card erases all folders regardless if they are selected or not.

SETUP MENU - CUSTOM 2

RESETTING THE CAMERA

This function affects all modes. When selected, a confirmation screen will appear; choosing “Yes” resets the following functions and settings, “No” cancels the operation.

	Default Setting	Page
Exposure mode	Program	52
Focus mode	Autofocus	56
Focus area	Wide focus area	48
Digital zoom	On	22
Drive mode	Single-frame advance	32
Flash mode	Auto flash	30
Image quality	Standard	41
Image size	2272 X 1704	40
Voice memo	Off	43
Date imprinting	Off	44
Instant playback	Off	45
Metering mode	Multi-segment	58
Exposure compensation	0.0	46
Camera sensitivity (ISO)	Auto	57
White balance	Auto white balance	54
Exposure bracket	0.5 Ev	59
Colour mode	Colour	60

Continued on next page

SETUP MODE

	Default Setting	Page
Sharpness	Normal	60
Contrast	Normal	60
Colour-saturation	Normal	60
Index playback format	9 frames	75
Duration (Slide Show)	5 seconds	76
Repeat (Slide Show)	No	76
Index print	No (Canceled)	79
LCD monitor brightness	3	86
Auto-power-save period	1 minute	87
Audio signals	On	87
File number memory	Off	88

SETTING THE DATE AND TIME

It is important to accurately set the clock. When a still image or a movie clip is recorded, the date and time of the recording are saved with the image and are displayed during playback or can be read with the DiIMAGE Image Viewer Utility software included on the CD-ROM. The camera's clock is also used with date imprinting (p. 44).

When the Date/Time-set option is selected and entered, the date/time screen will be displayed. The left/right keys of the controller are used to select the item to be changed and the up/down keys are used to change the value. From left to right, the screen shows the year, month, day, hour, and minute. When the date and time have been adjusted, set the clock by pressing the center of the controller.

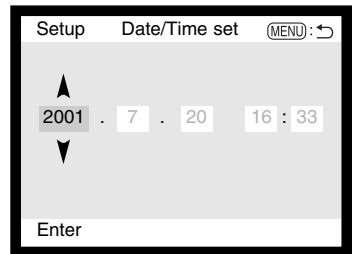

SETTING THE DATE FORMAT

The date format that is displayed or imprinted can be changed: YYYY/MM/DD (year, month, day), MM/DD/YYYY (month, day, year), DD/MM/YYYY (day, month, year). Simply select the format and enter it by pressing the center of the controller; the new format will be displayed on the menu.

VIDEO OUTPUT

Camera images can be displayed on a television (p. 82). The video output can be changed between NTSC and PAL. North America uses the NTSC standard and Europe uses the PAL standard. Check which standard is used in your region to play back images on your television set.

MINOLTA HISTORY

On February 20th, 1962, John Glenn became the first American to orbit the Earth. On board his Friendship 7 spacecraft was a Minolta Hi-matic camera to record that historic event. The 4 hour, 55 minute, and 23 second flight orbited the Earth three times at an average speed of 28,000 kph (17,500 mph).

Mr. Glenn visited our Sakai camera factory in Japan on May 24th, 1963 to plant a palm tree to celebrate the occasion. The palm tree is still in the courtyard of the factory and stands over eight meters tall (26ft).

The camera? It was not lost. It is on display at the Smithsonian Institution's National Air and Space Museum in Washington D.C. This and other objects from John Glenn's Friendship 7 Mercury flight can be found in galley 210, "Apollo to the Moon."



DATA-TRANSFER MODE

CONNECTING TO A COMPUTER

Read this section carefully before connecting the camera to a computer. Details on using and installing the DiIMAGE Image Viewer Utility software are found in the supplied software manual. The DiIMAGE manuals do not cover the basic operation of computers or their operating systems; please refer to the manual supplied with your computer.

For the camera to be connected directly to the computer and used as a mass-storage device, the computer must be equipped with a USB port as a standard interface. The computer and the operating system must be guaranteed by their manufacturers to support USB interface. The following operating systems are compatible with the camera:

IBM PC / AT Compatible	Macintosh
Windows 98, 98SE, Me, 2000 Professional, and XP.	Mac OS 8.6 ~ 9.2.1 and Mac OS X 10.1

Users with Windows 98 or 98 second edition will need to install the driver software on the included DiIMAGE software CD-ROM (p. 67). Users with Mac OS 8.6 will need to download and install a USB mass-storage device from the Apple web site (p. 70).

Customers who have bought a DiIMAGE 7, 5, S304, X, or 2330 digital camera and have installed the Windows 98 driver software must repeat the installation procedure. The updated version of the driver software included on the supplied DiIMAGE software CD-ROM is required for the operation of the DiIMAGE X with a computer. The new software will have no affect on the performance of the DiIMAGE 7, 5, S304, X, or 2330.

ARCISOFT PHOTOIMPRESSION SYSTEM REQUIREMENTS

IBM PC / AT Compatible	Macintosh
Pentium-based computer	Power PC
Windows 95, 98, 98SE, NT 4.0, Me, 2000 Professional, and XP.	Mac OS 8.5 - 9.2.1
32MB or more of RAM (128MB or more with Windows XP)	32MB or more of RAM (64MB or more is recommended)
125MB or more of hard disk space	120MB or more of hard disk space
A monitor with 32000 colours or more	A monitor with 32000 colours or more

PhotoImpression is an application software for still images. To install PhotoImpression, follow the instructions in the read-me folder and installer.

QUICKTIME SYSTEM REQUIREMENTS

IBM PC / AT Compatible
Pentium-based computer
Windows 95, 98, 98SE, NT, Me, or 2000 Professional.
32MB or more of RAM
Sound Blaster or compatible sound card
DirectX 3.0 or later recommended

QuickTime is used for viewing movie clips and playing voice-memo audio files. To install QuickTime, follow the instructions in the read-me folder and in the installer. Macintosh users can download the latest version of QuickTime free of charge from the Apple Computer web site: <http://www.apple.com>.

CAMERA NOTES

To view images correctly on your computer, the monitor's colour space may need to be adjusted. Refer to your computer manual on how to calibrate the display to the following requirements: sRGB, with a colour temperature of 6500K, and a gamma of 2.2. Changes made to the captured image with the camera's contrast and colour-saturation controls will affect any colour-matching software in use.

DATA-TRANSFER MODE

CONNECTING THE CAMERA TO A COMPUTER

A fresh set of batteries should be used when the camera is connected to a computer. The use of the AC adapter (sold separately) is recommended over the use of batteries. For users with Windows 98, 98SE, or Mac OS 8.6, read the respective sections on how to install the necessary USB driver before connecting the camera to a computer (Windows 98 - p. 96, OS 8.6 - p. 99).

- 1 Start up the computer.
 - The computer must be turned on before connecting the camera.

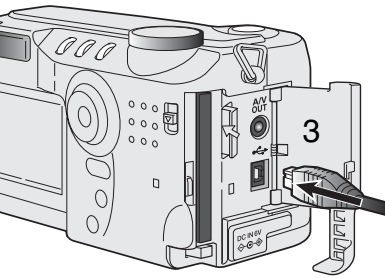

- 2 Insert the CompactFlash card into the camera.
 - Confirm that the correct card is in the camera. To change the CompactFlash while the camera is connected to a computer, see page 104.

- 3 Open the card-slot door. Attach the smaller plug of the USB cable to the camera.
 - Make sure the plug is firmly attached.

- 4 Attach the other end of the USB cable to the computer's USB port.
 - Make sure the plug is firmly attached.
 - The camera should be connected directly to the computer's USB port. Attaching the camera to a USB hub may prevent the camera from operating properly.

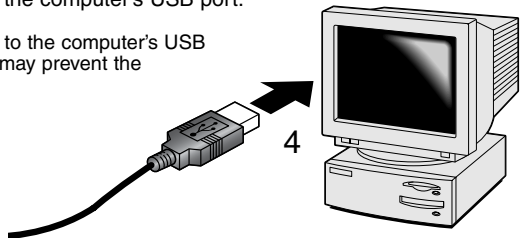

- 5 Set the mode dial to the data-transfer position to initiate the USB connection.
- A screen will appear to indicate the beginning of the connection process. When the signal has been received by the computer, the LCD monitor will turn off.

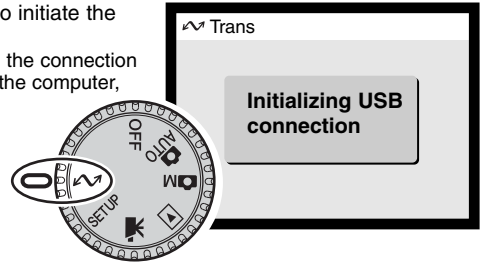

When the camera is properly connected to the computer, a drive icon will appear. When using Windows XP, the removable-disk window will open. If the computer does not recognize the camera, disconnect the camera and restart the computer. Repeat the connection procedure above.

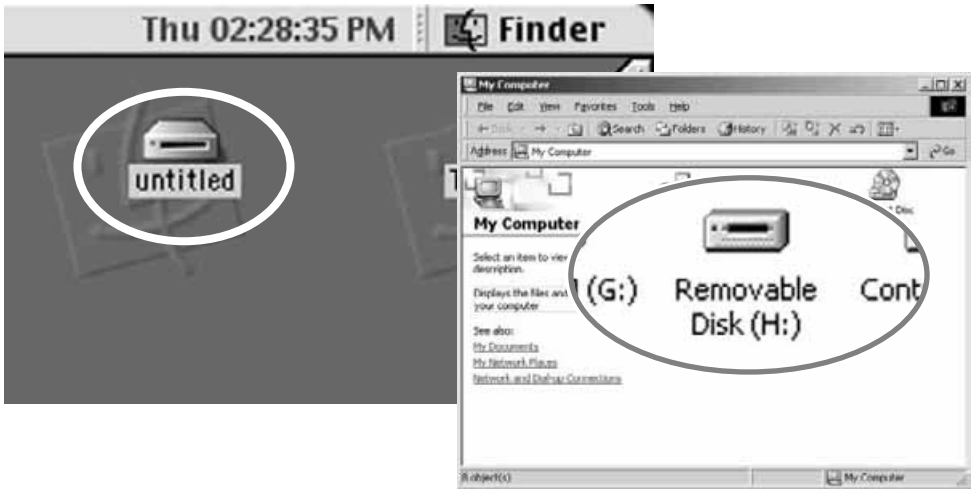

DATA-TRANSFER MODE

CONNECTING TO WINDOWS 98 AND 98SE

The driver needs only to be installed once. If the driver cannot be installed automatically, it can be installed manually with the operating system's add-new-hardware wizard; see the instructions on the following page. During installation, if the operating system requests the Windows 98 CD-ROM, insert it into the CD-ROM drive and follow the accompanying instructions on the screen.

AUTOMATIC INSTALLATION



Before connecting the camera to the computer, place the DiMAGE software CD-ROM in the CD-ROM drive. The DiMAGE installer menu should automatically activate. To automatically install the Windows 98 USB driver, click on the starting-up-the-USB-device-driver-installer button. A window will appear to confirm that the driver should be installed; click "Yes" to continue.

When the driver has been successfully installed, a window will appear. Click "OK." Restart the computer before connecting the camera (p. 94).



MANUAL INSTALLATION

To install the Windows 98 driver manually, follow the instructions in the connecting-the-camera-to-a-computer section on page 94.

When the camera is plugged into the computer, the operating system will detect the new device and the add-new-hardware-wizard window will open. Place the DiMAGE software CD-ROM in the CD-ROM drive. Click "Next."



Choose the recommended search for a suitable driver. Click "Next."



Choose to specify the location of the driver. The browse window can be used to indicate the driver location. When the location is shown in the window, click "Next."

- The driver should be located in the CD-ROM drive at :Win98\USB.



(Continued on the next page)

DATA-TRANSFER MODE



The last window will confirm the driver has been installed. Click "Finish" to close the add new hardware wizard. Restart the computer.

The add new hardware wizard will confirm the location of the driver. Click "Next" to install the driver in the system.

- One of three drivers may be located: MNLVENUM.inf, USBPDR.inf, or USBSTRG.inf.
- The letter designating the CD-ROM drive will vary between computers.

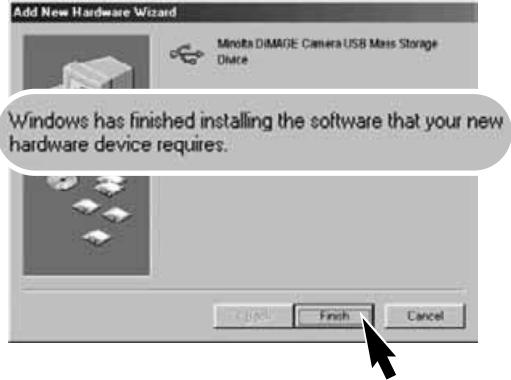

When the my-computer window is opened, a new removable-disk icon will be displayed. Double click on the icon to access the camera's CompactFlash card; see page 100.

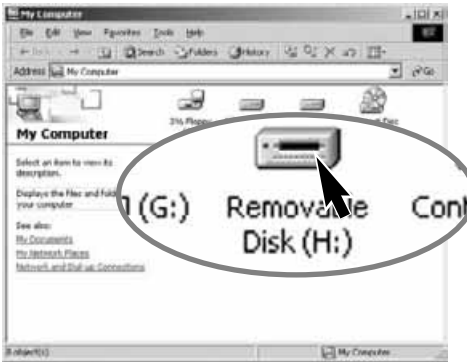

CONNECTING TO MAC OS 8.6

To access this camera with a computer with Mac OS 8.6, the USB storage support 1.3.5.smi must be installed first. This software is supplied by Apple Computer, Inc. free of charge. It can be downloaded from the Apple Software Updates web site at <http://www.apple.com/support>.



USB Storage Support 1.3.5.smi

To download and install this software, follow the instruction on the Apple web site. Always read the attached terms and conditions before installing any new software.

AUTO POWER SAVE (DATA-TRANSFER MODE)

If the camera does not receive a read or write command within ten minutes, it will shut down to save power. When the camera shuts down, an unsafe-removal-of-device warning may appear on the computer monitor. Click "OK." Neither the camera or computer will be damaged in this operation.

Turn off the camera with the mode dial. Remake the USB connection by turning the mode dial back to the data-transfer position.

DATA-TRANSFER MODE

COMPACTFLASH CARD FOLDER ORGANIZATION



Drive Icon



Misc

The misc. folder contains DPOF print files (p. 78).



Dcim

The last two digits in the folder name indicate the camera that was used to capture the images; "12" indicates a DiIMAGE S404.



100MLT12



101MLTCP

Images copied from one CompactFlash to another (p. 80) are placed in a folder with a name ending in "CP." When a new folder is created, the first three digits in the folder name will be one greater than the largest folder number on the card.

Image-file names begin with "pict," followed by a four-digit file number, and a tif, jpg, avi, or thm extension. Voice-memo audio files have a wav extension and the file name corresponds to its image file. The thumbnail images (thm) are used in camera operation and cannot be opened.



PICT0001.TIF

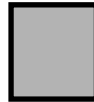

PICT0001.THM

Super-fine image



PICT0002.JPG

Fine, standard, or economy image

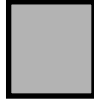

PICT0002.WAV

PICT0002's voice-memo audio file



PICT0003.AVI



PICT0003.THM

Movie clip

Once the camera is connected to the computer, image files can be accessed by simply double clicking on icons. Copying images can be done by dragging and dropping the image-file icon into a location in the computer. Files and folders on the CompactFlash card can be deleted using the computer. Never format the CompactFlash card from the computer; always use the camera to format the card.

The index number on the image file may not correspond to the frame number of the image. As images are deleted on the camera, the frame counter will adjust itself to show the number of images in the folder and reassign the frame numbers accordingly. The index numbers on the image files will not change when an image is deleted. When a new image is recorded, it will be assigned a number one greater than the largest index number in the folder. File numbers can be controlled with the file-number-memory function in the custom 1 section of the setup menu (p. 88).

When the index number in the image file name exceeds 9,999, a new folder will be created with a number one greater than the greatest folder number on the CompactFlash card: e.g. from 100MLT12 to 101MLT12. When a DPOF file is created for a print order (p. 78), a misc. folder is automatically made for the file.

CAMERA NOTES

Image files contain exif tag data. This data includes the time and date the image was recorded as well as the camera settings used. This data can be viewed with the camera or the DiIMAGE Image Viewer utility software.

If a camera image is opened in a photo-retouching application like Arcsoft PhotoImpression, and then the image is saved overwriting the original data, the exif tag information will be erased. When using software other than the DiIMAGE Image Viewer Utility, always rename the image file to protect the exif tag data.

DATA-TRANSFER MODE

DISCONNECTING THE CAMERA FROM THE COMPUTER

Never disconnect the camera when the access lamp is lit - the data or CompactFlash card may permanently be damaged.

WINDOWS 98 AND 98SE

Confirm that the access lamp is not lit. Turn the mode dial to another position and then disconnect the USB cable.

WINDOWS ME, 2000 PROFESSIONAL, AND XP



To disconnect the camera, left click on the unplug-or-eject-hardware icon located on the task bar. A small window will open indicating the device to be stopped.



Click on the small window to stop the device. The safe-to-remove-hardware window will appear. Click "OK." Turn the mode dial to another position and then disconnect the USB cable.



When more than one external device are connected to the computer, repeat the procedure above except right click on the unplug-or-eject-hardware icon. This will open the unplug-or-eject-hardware window after clicking on the small window indicating the device.



On the unplug-or-eject-hardware window, the hardware devices to be stopped will be displayed. Highlight the device by clicking on it then click “Stop.”



A confirmation screen will appear to indicate the devices to be stopped. Clicking “OK” will stop the device.

A third and final screen will appear to indicate the camera can be safely disconnected from the computer. Turn the mode dial to another position and then disconnect the USB cable.

MACINTOSH

Confirm that the access lamp is not lit and then drag the mass-storage device icon and drop it into the trash.

Disconnect the USB cable.

- If the USB cable is disconnected before performing the first step, an alert message will appear. Always complete the first step before disconnecting the USB cable.

DATA-TRANSFER MODE

CHANGING THE COMPACTFLASH CARD (DATA-TRANSFER MODE)

Care should be taken when changing CompactFlash cards while the camera is attached to the computer. Data could be lost or damaged if the camera is not properly disconnected.

Always confirm the access lamp is out
before removing the CompactFlash card.

WINDOWS 98 AND 98SE

1. Turn off the camera.
2. Change the CompactFlash card.
3. Turn the mode dial to the data-transfer position to remake the USB connection.

WINDOWS ME, 2000 PROFESSIONAL, AND XP

1. Stop the USB connection using the unplug-or-eject-hardware routine (p. 102).
2. Turn off the camera.
3. Change the CompactFlash card.
4. Turn the mode dial to the data-transfer position to remake the USB connection.

MACINTOSH

1. Stop the USB connection by dragging the drive icon into the trash (p. 103).
2. Turn off the camera.
3. Change the CompactFlash card.
4. Turn the mode dial to the data-transfer position to remake the USB connection.

TROUBLESHOOTING

The section covers minor problems with basic camera operation. For major problems or damage, or if a problem continues to reoccur frequently, contact a Minolta service facility listed on the back cover of this manual.

Problem	Symptom	Cause	Solution
The camera will not work.	Nothing displayed on the data panel or the monitors.	The batteries are dead.	Replace batteries (p. 16).
		The batteries are inserted incorrectly.	Reinsert the batteries taking care that the negative and positive terminals are orientated as indicated on the inside of the battery chamber door (p.16).
		The AC adapter is not connected properly.	Check that the adapter is connected to the camera and a live electrical outlet (p. 18).
	The camera was accidentally turned on while in a bag or case, or the lens was hindered while extending.	Turn the camera off and on to restore operation.	
Shutter will not release.	"000" is displayed on the frame counter.	CompactFlash card is full and unable to store an image at the image-quality or image-size setting on the camera.	Insert a new CompactFlash card (p. 18), delete some images (p. 72), or change the image-quality or image-size setting (p. 38, 50).
	No-card warning appears on the monitors.	No CompactFlash card in the camera.	Insert a CompactFlash card (p.18).

TROUBLESHOOTING

Problem	Symptom	Cause	Solution
Pictures are not sharp.	Focus signal is red.	Subject is too close.	Make sure the subject is within the autofocus range (p. 24) or use the macro mode (p. 28).
		The camera is in macro mode.	Cancel the macro mode setting (p. 28).
		A special situation is preventing the autofocus system from focusing (p.25)	Use the focus-lock function to focus on an object at the same distance as the subject (p. 24) or use manual focus (p. 56).
	Pictures are taken indoors or in low-light situations without flash.	Slow shutter speeds result in blurred images when the camera is hand-held.	Use a tripod, change the camera sensitivity to a higher setting (p. 50), or use the flash (p. 30).
Continuous drive does not work.	The image quality is set to super fine.		Change the image-quality setting (p. 38, 50).
While using flash, the pictures are too dark.		The subject is beyond the flash range (p. 57).	Move closer to the subject or change the camera sensitivity to a higher setting (p. 50).
“Err” displayed on the data panel.	Turn off the camera and remove the batteries or unplug the external power supply. Wait for the message to disappear before reinserting the batteries or plugging in the power supply. If the camera is hot, allow it to cool before removing the batteries and Compactflash card.		

Problem	Symptom	Cause	Solution
Shooting data is displayed, but live image is entirely black or white.	Camera set to manual-exposure mode (M).	Shutter speed and aperture combination is extremely under or over-exposing the live image.	Change the shutter speed or aperture value until an image appears on the monitor (p. 53).

If the camera does not function normally, turn it off, remove and reinsert the batteries, or unplug and reconnect the AC adapter. Always turn the camera off using the mode dial otherwise the CompactFlash card may be damaged and camera settings reset.

The camera temperature rises with extended periods of use. Care should be taken to avoid burns when handling the camera, batteries, or CompactFlash card.

ABOUT NI-MH BATTERIES

When using Ni-MH batteries, clean both battery terminals with dry cloth to wipe off any dirt or residue. Because of the sophisticated computer system, the camera critically monitors power levels. If the battery terminals are dirty, the camera may give a false low-battery warning. If battery performance is unusually low, wipe the battery terminals with a clean, dry cloth.

Ni-MH battery performance will decrease if the batteries are often recharged before they have been fully discharged. Completely exhaust the Ni-MH batteries using the camera before charging.

TROUBLESHOOTING

REMOVING THE DRIVER SOFTWARE - WINDOWS

1. Insert a memory card in the camera and connect it to the computer with the USB cable. Other devices must not be connected to the computer during this procedure.

2. Right click on the My-computer icon. Select "properties" from the drop-down menu.

Windows XP: from the start menu go to the control panel. Click on the performance and maintenance category. Click "System" to open the system properties window.

3. Windows 2000 and XP: select the hardware tab in the properties window and click the device-manager button.

Windows 98 and Me: click the device-manager tab in the properties window.

4. The driver file will be located in the universal-serial-bus-controller or other-devices location of the device manager. Click on the locations to display the files. The driver should be indicated with the camera name. Under certain conditions, the driver name may not contain the camera name. However, the driver will be indicated by either a question mark or exclamation point.

5. Click on the driver to select it.

6. Windows 2000 and XP: click on the action button to display the drop-down menu. Select "uninstall." A confirmation screen will appear. Clicking "Yes" will remove the driver from the system.

Windows 98 and Me: click the remove button. A confirmation screen will appear. Clicking "Yes" will remove the driver from the system.

7. Disconnect the USB cable and turn off the camera. Restart the computer.

CARE AND STORAGE

CAMERA CARE

- Do not subject the camera to shock or impact.
- Turn off the camera when transporting.
- This camera is neither waterproof nor splashproof. Inserting or removing batteries or the CompactFlash card, or operating the camera with wet hands may damage the camera.
- When at the beach or near water, take care not to expose the camera to water or sand. Water, sand, dust, or salt can damage the camera.
- Do not leave the camera under direct sunlight. Do not point the lens directly at the sun; the CCD may be damaged.

CLEANING

- If the camera or the outside of the lens is dirty, gently wipe it with a soft, clean, dry cloth. If the camera or lens comes in contact with sand, gently blow away loose particles. Wiping may scratch the surface.
- To clean the lens surface, first blow away any dust or sand, then, if necessary, moisten a lens tissue or soft cloth with lens cleaning fluid and gently wipe the lens.
- Never use organic solvents to clean the camera.
- Never touch the lens surface with your fingers.

STORAGE

- Store in a cool, dry, well-ventilated area away from dust and chemicals. For long periods of disuse, store the camera in an airtight container with a silica-gel drying agent.
- Remove the batteries and CompactFlash card from the camera when not in use for extended periods.
- Do not store the camera in an area with naphthalene or mothballs.
- During long periods of storage, operate the camera occasionally. When taking the camera out of storage, check that the camera is functioning properly before using.

CARE AND STORAGE

OPERATING TEMPERATURES AND CONDITIONS

- This camera has been designed for use in temperatures from 0°C to 40°C (32°F to 104°F).
- Never leave the camera exposed to extreme high temperatures, such as in a car parked in the sun, or to extreme humidity.
- When taking the camera from a cold to a warm environment, place it in a sealed plastic bag to prevent condensation from forming. Allow the camera to come to room temperature before removing it from the bag.

COMPACTFLASH CARD CARE AND HANDLING

- The following may cause data loss or damage.
 - 1 Improper use of the card.
 - 2 Static electrical discharge or electromagnetic fields near the card.
 - 3 Removing the card or interrupting the power supply while the camera or computer is accessing the card (reading, writing, formatting, etc.).
 - 4 The disuse of a card for an extended period.
 - 5 Using the card beyond its life
- Minolta has no responsibility for any loss or damage to data. It is recommended that a copy of the card data be made in another media such as a ZIP disc, hard disk, CD-ROM, etc.
- When the card is formatted, all recorded data will be deleted. Be sure to make a backup of any important data.
 - The storage capability of the CompactFlash card will diminish with extended use. It may be necessary to purchase a new card periodically.
 - Keep away from static electricity and electromagnetic fields.
 - Do not bend, drop, or subject the card to impact.
 - Strong static electrical discharges or physical shock may prevent the card from being able to transfer data.
 - Do not touch the electrical contacts of the card with your fingers or metal objects.
 - Keep away from heat, moisture, and direct sunlight.
 - Keep away from small children.

BATTERIES

- Battery performance decreases with temperature. In cold environments, we recommend keeping spare batteries in a warm place, such as the inside of a coat. Batteries can recover their power when they warm up. As the performance of Ni-MH batteries are less affected by temperature, their use is recommended when shooting in cold environments.
- Remove the batteries when the camera is not in use for an extended period. Leaking battery fluid may damage the battery-chamber.
- Occasionally, when using alkaline batteries, the battery-condition indicator will give a false low-battery-power warning, even though there is enough power capacity. Continue to use the camera; the low-battery indicator will disappear.
- If batteries have been exhausted when used in the camera, do not reload them even if their charge seems to recover over time. These batteries will interfere with normal camera operation.

LCD MONITOR CARE

- Although the LCD monitor is manufactured using high precision technology, there may occasionally be a lack of colour or bright points on the LCD monitor.
- Do not apply pressure to the surface of the LCD monitor; it may be permanently damaged.
- In a cold environment, the LCD monitor may become temporarily dark. When the camera warms up, the display will function normally.
- The LCD monitor may be slow to react in low temperatures or may turn dark in a hot environment. When the camera reaches normal operating temperature, the display will function normally.
- If fingerprints are on the LCD monitor surface, gently wipe with a soft, clean, dry cloth.

COPYRIGHT

- TV program, films, video tapes, photographs, and other materials may be copyrighted. Unauthorized recording or duplication of such material may be contrary to copyright laws. Taking pictures or images of performances, exhibitions, etc., is prohibited without approval and can infringe on copyright. Images protected by copyright can only be used under the provisions within the copyright laws.

CARE AND STORAGE

BEFORE IMPORTANT EVENTS OR JOURNEYS

- Check the camera's operation; take test pictures and purchase spare batteries.
- Minolta has no responsibility for any damage or loss incurred by equipment malfunction.

QUESTIONS AND SERVICE

- If you have questions about your camera, contact your local camera dealer or write to the Minolta distributor in your area.
- Before shipping your camera for repair, please contact a Minolta Service Facility.

The following marks may be found on the product:



This mark certifies that this camera meets the requirements concerning interference causing equipment regulations in Japan.



This mark on your camera certifies that this camera meets the requirements of the EU (European Union) concerning interference causing equipment regulations. CE stands for *Conformité Européenne* (European Conformity).

Digital Camera: DiIMAGE S404



Tested To Comply
With FCC Standards

FOR HOME OR OFFICE USE

This device complies with Part 15 of the FCC Rules. Operation is subject to the following two conditions: (1) This device may not cause harmful interference, and (2) this device must accept any interference received, including interference that may cause undesired operation.

Tested by the Minolta Corporation
101 Williams Drive, Ramsey, New Jersey 07446, U.S.A.

This Class B digital apparatus complies with Canadian ICES-003.

Cet appareil numérique de la classe B est conforme à la norme NMB-003 du Canada.

Do not remove the ferrite cores from the cables.

Apple, the Apple logo, Macintosh, Power Macintosh, Mac OS, and the Mac OS logo are registered trademarks of Apple Computer Inc. Microsoft and Windows are registered trademarks of the Microsoft Corporation. The official name of Windows® is Microsoft Windows Operating System. Pentium is a registered trademark of the Intel Corporation. PhotoImpression is a trademark of ArcSoft, Inc. Power PC is a trademark of the International Business Machines Corporation. QuickTime is a trademark used under license. All other trademarks are the property of their respective owners.

TECHNICAL SPECIFICATIONS

Number of effective pixels:	3.95 million
CCD:	1/1.8-type interline primary-colour CCD with a total of 4.13 million pixels.
Camera sensitivity (ISO):	Auto and 64, 100, 200, and 400 ISO equivalents.
Aspect ratio:	4:3
Lens construction:	11 elements in 9 groups including one AD glass and two double-sided aspheric elements.
Maximum aperture:	f/3.0 (wide-angle position), f/3.6 (telephoto position)
Focal length:	7.15 - 28.6 mm (35mm equivalent: 35 - 140 mm)
Focusing range (from the CCD):	0.5 m - infinity (wide-angle position) 0.9 m - infinity (telephoto position) 0.16 - 0.6 m in macro mode
Filter diameter:	35.5 mm
Autofocusing system:	Video AF
Shutter:	CCD electronic shutter plus mechanical shutter
Shutter speeds:	1/1000 - 4s, bulb (15s maximum)
Built-in flash recycling time:	8s (approx)
Viewfinder:	Optical real-image zoom viewfinder.
Monitor LCD:	46 mm TFT colour
Monitor field of view:	Approximately 100%
A/D conversion:	12 bits
Recording media:	Type I CompactFlash cards
File formats:	Exif 2.1 (JPEG, TIFF), motion JPEG (avi), WAV. DCF 1.0 and DPOF compliant.
Print Image Matching:	Yes
Menu languages:	Japanese, English, German, French, and Spanish
Video output:	NTSC and PAL

Batteries:	4 AA Ni-MH or alkaline batteries. Ni-MH batteries are recommended over alkaline.
Battery performance (recording):	Approximately 150 frames: based on Minolta's standard test method: 1,700mAh Ni-MH batteries, LCD monitor on, full-size images (2272 X 1704), standard image quality, no instant playback, no voice memo, flash used with 50% of the frames. Approximately 280 frames: based on Minolta's standard test method: 1,700mAh Ni-MH batteries, LCD monitor off, full-size images (2272 X 1704), standard image quality, no instant playback, no voice memo, flash used with 50% of the frames.
Battery performance (playback):	Approx. continuous playback time: 110 min. Based on Minolta's standard test method: 1,700mAh Ni-MH batteries, LCD monitor on.
External power source:	AC adapter (AC-1L or AC-2L) High-power battery pack (EBP-100)
Dimensions:	113.5 (W) X 64.5 (H) X 58.5 (D) mm
Weight:	Approximately 335g (without batteries or CompactFlash card)
Operating temperature:	0° - 40°C
Operating humidity:	5 - 85% (noncondensing)

Specifications are based on the latest information available at the time of printing and are subject to change without notice.

MINOLTA

© 2002 Minolta Co., Ltd. under the Berne Convention
and the Universal Copyright Convention.

Printed in Japan

9224-2781-11 H-A201 020124