

# MINOLTA

The essentials of imaging

[www.minoltaeurope.com](http://www.minoltaeurope.com)



# *DiMAGE* S414

**E** INSTRUCTION MANUAL

## BEFORE YOU BEGIN

Thank you for purchasing this Minolta digital camera. Please take the time to read through this instruction manual so you can enjoy all the features of your new camera. Check the packing list before using this product. If any items are missing, immediately contact your camera dealer.

Minolta DiMAGE S414 digital camera  
AA alkaline batteries (set of four)  
Neck strap NS-DG304  
Lens cap LF-236  
CompactFlash card  
AV cable AVC-100  
USB cable USB-600  
DiMAGE Viewer CD-ROM  
DiMAGE Viewer instruction manual (PDF)  
Camera manual (PDF)  
Quick Reference Guide  
Minolta International Warranty Certificate

### Camera Notes

Because the performance of alkaline batteries with digital cameras is low, the use of Ni-MH batteries is recommended. Although alkaline batteries are supplied with this product, its performance will be limited; only use alkaline batteries for test photographs or when Ni-MH batteries, the Minolta external battery pack, or the AC adapter are not available. Fully recharge the Ni-MH batteries just before using the camera.

Apple, the Apple logo, Macintosh, Power Macintosh, Mac OS, and the Mac OS logo are registered trademarks of Apple Computer Inc. Microsoft and Windows are registered trademarks of the Microsoft Corporation. The official name of Windows is Microsoft Windows Operating System. Pentium is a registered trademark of the Intel Corporation. Power PC is a trademark of the International Business Machines Corporation. QuickTime is a trademark used under license. All other trademarks are the property of their respective owners.

# FOR PROPER AND SAFE USE

Read and understand all warnings and cautions before using this product.

## WARNING

Using batteries improperly can cause them to leak harmful solutions, overheat, or explode which may damage property or cause personal injury. Do not ignore the following warnings.

- Only use the batteries specified in this instruction manual.
  - Do not install the batteries with the polarity (+/-) reversed.
  - Do not use batteries which show wear or damage.
  - Do not expose batteries to fire, high temperatures, water, or moisture.
  - Do not attempt to short or disassemble batteries.
  - Do not store batteries near or in metallic products.
  - Do not mix batteries of different types, brands, ages, or charge levels.
  - Do not charge alkaline batteries.
  - When recharging rechargeable batteries, only use the recommended charger.
  - Do not use leaking batteries. If fluid from the batteries enters your eye, immediately rinse the eye with plenty of fresh water and contact a doctor. If fluid from the batteries makes contact with your skin or clothing, wash the area thoroughly with water.
  - Tape over battery contacts to avoid short-circuiting during disposal; always follow local regulations for battery disposal.
- 
- Use only the specified AC adapter within the voltage range indicated on the adapter unit. An inappropriate adapter or current may cause damage or injury through fire or electric shock.
  - Do not disassemble this product. Electric shock may cause injury if a high voltage circuit inside the product is touched.
  - Immediately remove the batteries or unplug the AC adapter and discontinue use if the camera is dropped or subjected to an impact in which the interior, especially the flash unit, is exposed. The flash has a high voltage circuit which may cause an electric shock resulting in injury. The continued use of a damaged product or part may cause injuries or fire.
  - Keep batteries or small parts that could be swallowed away from infants. Contact a doctor immediately if an object is swallowed.

- Store this product out of reach of children. Be careful when around children not to harm them with the product or parts.
- Do not fire the flash directly into the eyes. It may damage eyesight.
- Do not fire the flash at vehicle operators. It may cause a distraction or temporary blindness which may lead to an accident.
- Do not use the monitor while operating a vehicle or walking. It may result in injury or an accident.
- Do not look directly at the sun or strong light sources through the viewfinder. It may damage your eyesight or cause blindness.
- Do not use this product in a humid environment, or operate this product with wet hands. If liquid enters the product, immediately remove the batteries or unplug the AC adapter and discontinue use. The continued use of a product exposed to liquids may cause damage or injury through fire or electric shock.
- Do not use the product near inflammable gases or liquids such as gasoline, benzine, or paint thinner. Do not use inflammable products such as alcohol, benzine, or paint thinner to clean the product. The use of inflammable cleaners and solvents may cause an explosion or fire.
- When unplugging the AC adapter, do not pull on the power cord. Hold the adapter unit when removing it from an outlet.
- Do not damage, twist, modify, heat, or place heavy objects on the AC adapter cord. A damaged cord may cause damage or injury through fire or electric shock.
- If the product emits a strange odor, heat, or smoke, discontinue use. Immediately remove the batteries taking care not to burn yourself as the batteries become hot with use. The continued use of a damaged product or part may cause injuries or fire.
- Take the product to a Minolta Service Facility when repairs are required

## CAUTION

- Do not use or store the product in a hot or humid environment such as the glove compartment or trunk of a car. It may damage the product and batteries which may result in burns or injuries caused by heat, fire, explosion, or leaking battery fluid.
- If batteries are leaking, discontinue use of the product.

- The camera temperature rises with extended periods of use. Care should be taken to avoid burns.
- Burns may result if the memory card or batteries are removed immediately after extended periods of use. Turn the camera off and wait for it to cool.
- Do not fire the flash while it is in contact with people or objects. The flash unit discharges a large amount of energy which may cause burns.
- Do not apply pressure to the LCD monitor. A damaged monitor may cause injury, and the liquid from the monitor may cause inflammation. If liquid from the monitor makes contact with skin, wash the area with fresh water. If liquid from the monitor comes in contact with the eyes, immediately rinse the eyes with plenty of water and contact a doctor.
- When using the AC adapter, insert the plug securely into the electrical outlet.
- Do not use if the AC adapter cord is damaged.
- Do not cover the AC adapter. A fire may result.
- Do not obstruct access to the AC adapter; this can hinder the unplugging of the unit in emergencies.
- Unplug the AC adapter when cleaning or when the product is not in use.

The following marks may be found on the product:



This mark on your camera certifies that this camera meets the requirements of the EU (European Union) concerning interference causing equipment regulations. CE stands for Conformité Européenne (European Conformity).

Digital Camera: DiIMAGE S414



Tested To Comply  
With FCC Standards

FOR HOME OR OFFICE USE

This device complies with Part 15 of the FCC Rules. Operation is subject to the following two conditions: (1) This device may not cause harmful interference, and (2) this device must accept any interference received, including interference that may cause undesired operation. Do not remove the ferrite cores from the cables.

Tested by the Minolta Corporation

101 Williams Drive, Ramsey, New Jersey 07446, U.S.A.

This Class B digital apparatus complies with Canadian ICES-003.

Cet appareil numérique de la classe B est conforme à la norme NMB-003 du Canada.

# TABLE OF CONTENTS

The basic operation of this camera is covered between pages 15 and 42. This section of the manual covers the camera parts, preparation of the camera for use, and the basic camera operation for recording, viewing, and deleting images.

The basic and advanced auto-recording mode sections cover all the basic functions of the camera in this mode and in the multi-function recording mode. Take time to read these sections before moving on to the multi-function recording mode section. The basic playback section describes how to view images. The other sections can be read as needed.

Many of the features of this camera are controlled with menus. The menu navigation sections concisely describe how to change menu settings. Descriptions of the settings immediately follow the navigation sections.

Throughout the text are shooting tips and camera notes. Shooting tips give advice and information on photography and how to use the camera to achieve the best results. Camera notes cover details on camera operation.

Names of parts .....	10
Camera body .....	10
Viewfinder .....	12
Mode dial .....	12
Data panel .....	13
LCD monitor display .....	14
Getting up and running.....	15
Attaching the neck strap and lens cap .....	15
Changing batteries .....	16
Battery condition indicator .....	17
Auto power save .....	17
External power supplies (sold separately).....	18
Changing the CompactFlash card.....	18
Setting the date and time .....	20
Auto-recording mode - basic operation .....	22
Setting the camera to record images automatically .....	23
Handling the camera .....	24
Using the zoom lens.....	24

Basic recording operation.....	25
Focus lock.....	26
Focus range.....	26
Focus signals.....	27
Special focusing situations.....	27
Digital-subject-program button.....	28
Flash modes.....	30
Flash range - auto-recording mode.....	31
Flash signals.....	31
Camera-shake warning.....	31
Drive modes.....	32
Self-timer.....	33
Remote control (sold separately).....	34
Continuous advance.....	35
Bracketing.....	36
Display button - recording mode.....	37
Playback - basic operation.....	38
Single-frame playback and histogram display.....	38
Viewing and deleting images.....	39
Display button - playback.....	40
Enlarged playback.....	41
Auto-recording mode - advanced operation.....	42
Navigating the auto-recording mode menu.....	42
Image size and image quality.....	44
Voice memo.....	46
Date imprinting.....	47
Digital zoom.....	48
Instant playback.....	49
Exposure compensation.....	50
What is an Ev? What is a stop?.....	51
Multi-function recording mode.....	52
Autofocus areas and control.....	52
Navigating the multi-function recording mode menu.....	54
Exposure modes.....	56
Program.....	56
Aperture priority - A.....	56
Manual exposure - M.....	57
Bulb exposures.....	58
Focus modes.....	59
White balance.....	60
Automatic white balance.....	60
Preset white balance.....	60
Custom white balance.....	61
Camera sensitivity - ISO.....	62
Flash range and camera sensitivity.....	62
Full-time AF.....	63
Metering modes.....	63
Exposure bracketing increment.....	64
Color mode.....	64
Image control - sharpness, contrast, & filter.....	65

A short guide to photography .....	66
Movie recording.....	68
Notes on movie recording .....	69
Recording movies with the IR Remote Control RC-3 (sold separately) .....	69
Playback mode - advanced operation.....	70
Playing back voice memos .....	70
Viewing movies.....	71
Navigating the playback-mode menu .....	72
Frame-selection screen .....	74
Viewing images on a television .....	75
Deleting files .....	76
Locking files.....	77
Changing the index playback format .....	77
Slide Show.....	78
About DPOF .....	80
Creating a DPOF print order .....	80
Ordering an index print.....	81
Canceling a DPOF print order.....	81
Copying images.....	82
Setup mode .....	84
Navigating the setup menu.....	84
LCD monitor brightness.....	86
Formatting CompactFlash cards .....	86
Auto power save.....	86
Language.....	87
Display mode.....	87
File number (#) memory .....	88
Folder name.....	88
Select folder.....	89
Audio signals .....	89
Shutter FX .....	89
Volume.....	89
Resetting the camera .....	90
Date and time setting .....	91
Date format.....	91
Video output .....	91



- Data-transfer mode.....92
  - System requirements.....92
  - Connecting the camera to a computer .....93
  - Connecting to Windows 98 and 98 Second Edition .....95
    - Automatic installation.....95
    - Manual installation.....96
  - CompactFlash card folder organization.....98
  - Disconnecting the camera from the computer .....100
    - Windows 98 and 98 Second Edition .....100
    - Windows Me, 2000 Professional, and XP .....100
    - Macintosh .....101
  - Changing the CompactFlash card - data-transfer mode .....102
  - Auto power save - data-transfer mode .....102
  - QuickTime system requirements .....103
- Appendix .....103
  - Troubleshooting .....103
  - About Ni-MH batteries .....105
  - Removing the driver software - Windows .....106
  - Care and storage.....107
  - Technical specifications .....110

# CAMERA BODY

\* This camera is a sophisticated optical instrument. Care should be taken to keep these surfaces clean. Please read the care and storage instructions in the back of this manual (p. 107).

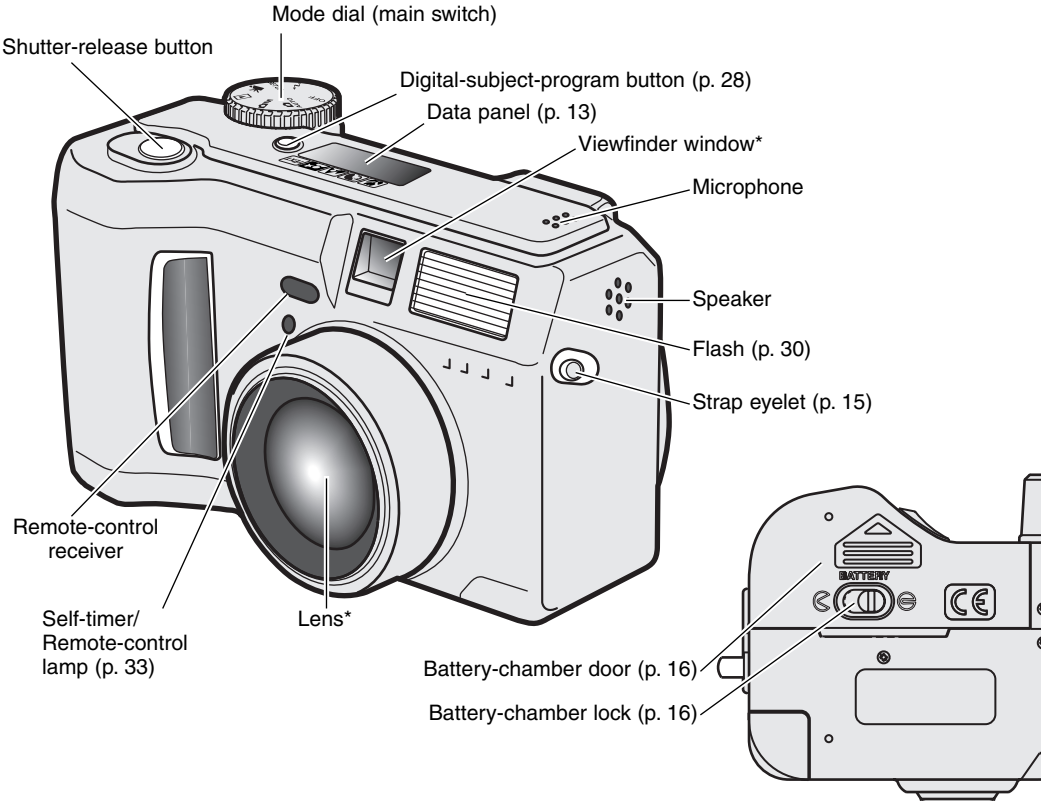

Flash mode/Magnification button (p. 30, 41)

Drive-mode button (p. 32)

Exposure-compensation button (p. 50)

Viewfinder\* (p. 12)

LCD monitor\*  
(p. 14)

Controller

Menu button

QV/ Delete button (p. 38)

Display button (p. 37, 40)

Access lamp

Card-slot door release

DC terminal cover (p. 18)

Card-slot door (p. 18)

The USB port and AV-out terminal are located behind the card-slot door.

Tripod socket

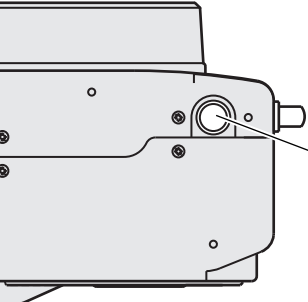

## VIEWFINDER

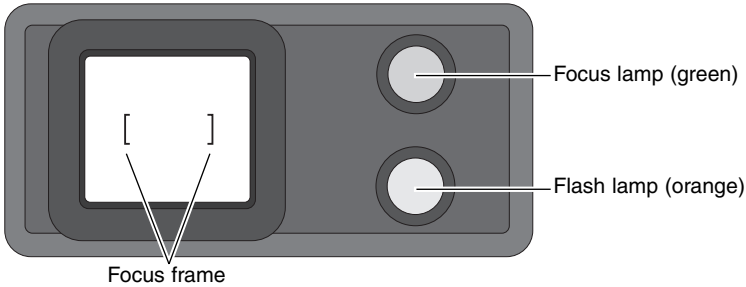



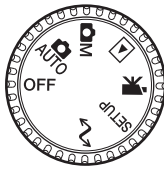

Because the optical viewfinder and the lens are slightly separated, the image seen through one is not exactly the same as the other; this is called parallax. Parallax can cause errors in framing at close distances and is more pronounced at longer focal lengths. When the subject is closer than 1m (3ft) at the wide-angle lens position or 3m (10ft) at the telephoto lens position, use the LCD monitor to compose the image; because the lens creates the monitor image, it does not suffer from parallax.

## MODE DIAL

This dial gives direct and easy access to the camera's major modes. It also acts as the main switch.



-  **AUTO** Auto-recording mode (p. 22, 42)
-  **M** Multi-function recording mode (p. 52)
-  Playback mode (p. 38, 70)
-  Movie-recording mode (p. 68)
- SETUP** Setup mode (p. 84)
-  Data-transfer mode (p. 92)

# DATA PANEL

 Digital-subject-program indicators (p. 28)

**WB** White-balance indicator (p. 60)

**MF** Manual-focus indicator (p. 59)

**ISO** Camera-sensitivity indicator (p. 62)

 Spot-metering indicator (p. 63)

  
**AUTO** Flash-mode indicators (p. 30)

**SIZE**  Image-size display (p. 44)

**QUAL**  Image-quality display (p. 44)

 Drive-mode indicators (p. 32)

 Microphone indicator (p. 46)

 Battery-condition indicator (p. 17)

 Exposure-compensation indicator (p. 50)

**AM** Exposure-mode indicators (p. 56)

Digital-subject-program icons (p. 28)

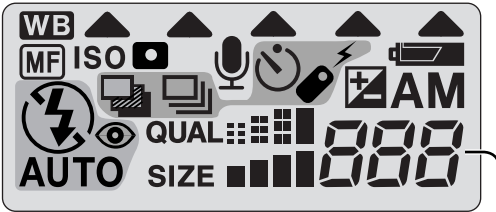

Frame counter (p. 45)

The frame counter cannot exceed 999. When the number of recordable images exceeds this, 999 will be displayed. The frame counter will continue to count down when the number of recordable images falls below one thousand.

# LCD MONITOR DISPLAY

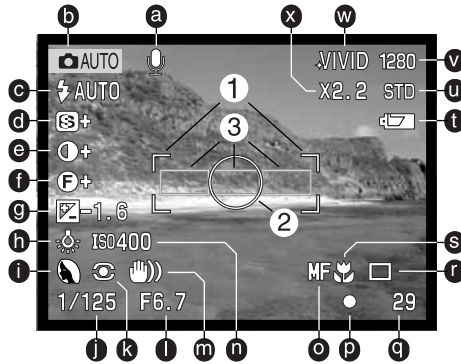

- |    |  |    |                                     |
|----|--|----|-------------------------------------|
| a. | Voice memo indicator (p. 46)   | o. | Manual-focus indicator (p. 59)      |
| b. | Mode indicator (p. 12)   | p. | Focus signal (p. 27)                |
| c. | Flash-mode indicator (p. 30)   | q. | Frame counter (p. 13)               |
| d. | Sharpness display (p. 65)  | r. | Drive-mode indicator (p. 32)        |
| e. | Contrast-compensation display (p. 65)                                | s. | Macro indicator (p. 28)             |
| f. | Filter display (p. 65)   | t. | Battery-condition indicator (p. 17) |
| g. | Exposure-compensation display (p. 50)                                | u. | Image-quality indicator (p. 44)     |
| h. | White-balance indicator (p. 60)                                      | v. | Image-size display (p. 44)          |
| i. | Exposure-mode (p. 56)/<br>Digital-subject-program indicators (p. 28) | w. | Color mode indicator (p. 48)        |
| j. | Shutter-speed display  | x. | Digital-zoom display (p. 48)        |
| k. | Metering-mode indicator (p. 63)                                      |    |                                     |
| l. | Aperture display   | 1. | Focus frame (p. 25)                 |
| m. | Camera-shake warning (p. 31)   | 2. | Spot metering area (p. 63)          |
| n. | Camera-sensitivity (ISO) display (p. 62)                             | 3. | AF sensors (p. 25)                  |

Indicators and displays from both the auto-recording and multi-function recording modes have been displayed for clarity.

# GETTING UP AND RUNNING

## ATTACHING THE NECK STRAP AND LENS CAP

Attach the small strap to the lens cap by passing one of the small loops through the eyelet on the cap (1) and then passing the other loop through the first loop (2) and tightening.

Attach the camera strap to the strap eyelets as shown. Make sure the neck strap passes through the loop of the lens-cap strap. Always keep the camera strap around your neck in the event that you drop the camera.

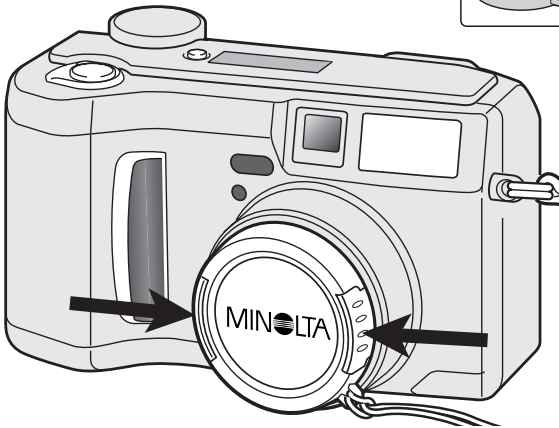
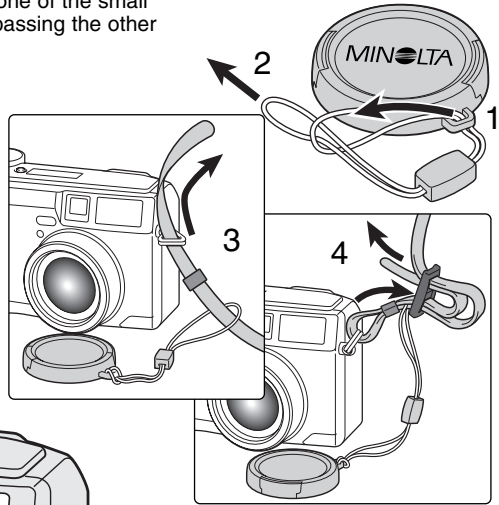

Using your thumb and index finger, pinch the outside tabs of the lens cap to remove or attach. Always replace the lens cap when the camera is not in use.

# CHANGING BATTERIES

This digital camera uses four AA-size alkaline or Ni-MH batteries. Ni-MH batteries are recommended because of longer life. When using Ni-MH batteries, fully recharge them with a battery charger suitable for complex electronic equipment. Please consult your vendor about an appropriate charger.

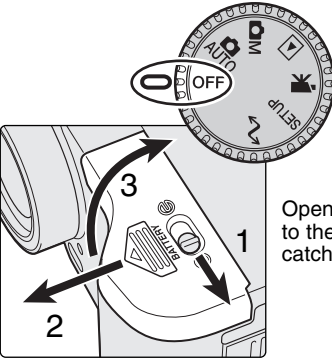

When replacing batteries, the mode dial should be in the off position. If the camera is not turned off when replacing exhausted batteries, the low-battery warning may not reset.

Open the battery-chamber door by moving the battery-chamber lock (1) to the open position. Slide the door forward (2) to release the safety catch; the door should spring open (3).

Insert the batteries. Make sure the positive and negative battery terminals are oriented as illustrated on the diagram in the battery chamber.

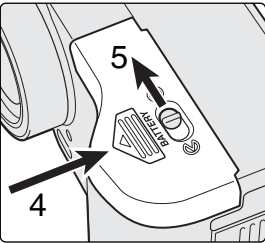
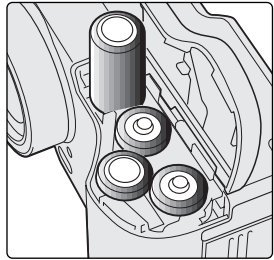

Close the battery-chamber door and slide it back toward the body (4) to engage the safety catch. Move the lock lever (5) to the close position.

After installing the batteries, the set-time/date message may appear on the monitor. The clock and calendar are set in the custom 2 section of the setup menu (p. 20).



## BATTERY CONDITION INDICATOR

This camera is equipped with an automatic battery-condition indicator. When the camera is on, the battery-condition indicator appears on the data panel and monitor. The monitor icon will change from white to red when battery power is low. If the data panel and monitor are blank, the batteries may be dead or installed incorrectly.



Full-battery icon - the batteries are fully charged. This icon is displayed for five seconds on the monitor when the camera is turned on. The icon remains on the data panel.



Low-battery warning - battery power is very low. The batteries should be replaced as soon as possible. This warning automatically appears and remains on the monitor until the batteries are changed.



Blinking low-battery icon - when displayed on the data panel with no other icons, power is insufficient for camera operation. The shutter will not release. When replacing exhausted batteries, wait thirty seconds between removing the old batteries and inserting the new ones.

When installing batteries, make sure the battery terminals are clean. Residue or dirt on the terminals can sometimes cause a false low-battery warning. Always use a clean, dry cloth to clean batteries.

## AUTO POWER SAVE

To conserve battery power, the camera will turn off displays and unnecessary functions if an operation is not made within a certain period. The LCD monitor will turn off after thirty seconds. The data panel turns off after one minute. To restore the displays, press any button or key, or turn the mode dial to another position. The length of the auto-power-save period for the data panel can be changed in the basic section of the setup menu (p. 84).

## EXTERNAL POWER SUPPLIES (SOLD SEPARATELY)

The AC Adapter allows the camera to be powered from an electrical household outlet. The AC Adapter is recommended when the camera is interfaced with a computer or during periods of heavy use. AC Adapter model AC-1L is for use in North America, Japan, and Taiwan; AC-2L is for use in all other areas.

The External High-power Battery Pack Kit EBP-100 is a portable source of power for the camera. The kit contains a high-power lithium-ion battery, holder, and charger. The battery and charger are also available separately. This battery pack will significantly extend the operating time of the camera.

 Always turn off the camera before changing between power supplies.

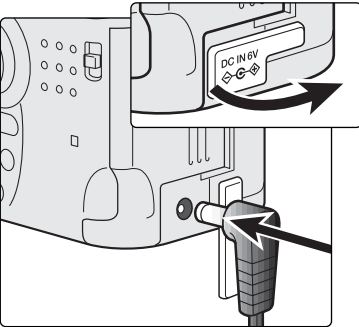
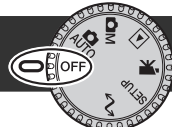

Remove the DC terminal cover from the left. The cover is attached to the body to prevent loss.

Insert the mini plug of the AC adapter or battery pack into the DC terminal. Always remove exhausted batteries before connecting an external power supply. Wait thirty seconds between removing the old batteries and plugging in the external power source.

Insert the AC adapter plug into an electrical outlet.

## CHANGING THE COMPACTFLASH CARD

A type I CompactFlash card must be inserted for the camera to operate. If a card has not been inserted, a no-card warning will automatically be displayed on the monitor and three dashes (---) will be displayed on the data-panel frame counter. For CompactFlash card care and storage, see page 109.

Always turn off the camera and confirm the access lamp is not lit before inserting or removing a CompactFlash card, otherwise the card may be damaged, and data lost.

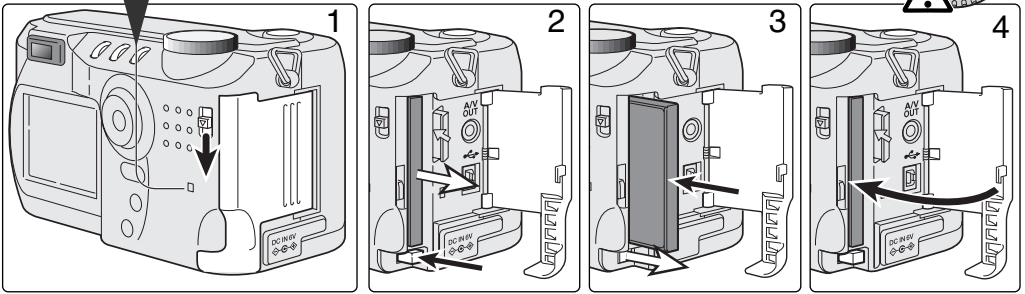
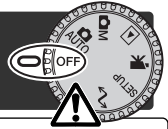

Slide the card-slot door release down to open the card-slot door (1).

To eject a CompactFlash card, press the card-eject lever (2). The card can now be pulled out. Take care when removing the card as it becomes hot with use.

Insert the memory card into the card slot until the card-eject lever pops out (3). Insert the card so the face is toward the front of the camera. Always push the card in straight, never at an angle. Never force the card. If the card does not fit, check that it is oriented correctly.

Close the card-slot door (4).

A card used in another camera may have to be formatted before being used. A card is formatted in the basic section of the setup menu (p. 84); this operation permanently erases all data on the card. If the unable-to-use-card message appears, the card is not compatible with the camera and cannot be formatted.

# SETTING THE DATE AND TIME

After initially inserting a memory card and batteries, the camera's clock and calendar must be set. When images are recorded, the image data is saved with the date and time of recording. Depending on the region, the menu language may also have to be set. To change the language, see the camera notes on the following page.

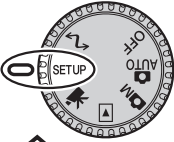

Turn the mode dial on the top of the camera to the setup position. The camera will turn on and the setup menu will be displayed.

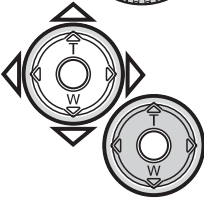

Navigating the menu is simple. The up/down and left/right keys of the controller move the cursor and change settings on the menu.

Pressing the center of the controller selects menu options and sets adjustments.

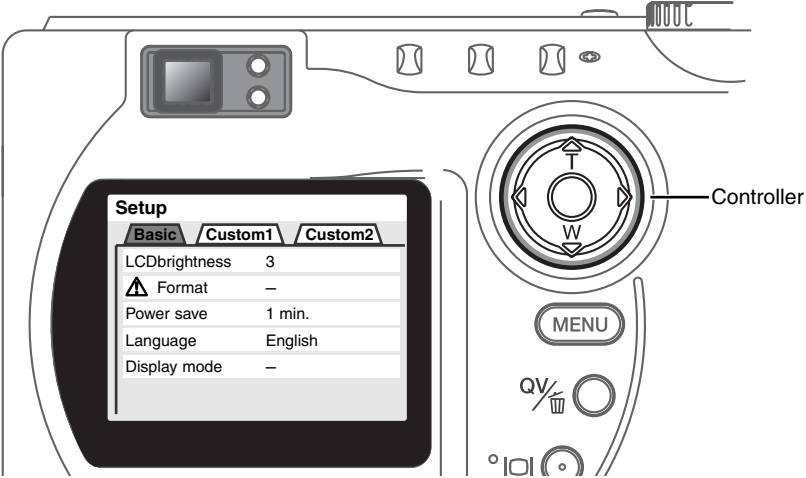

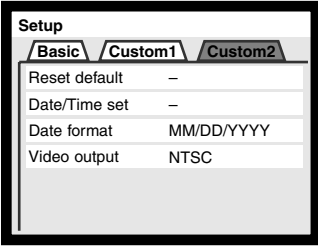

Custom 2 section of the setup menu



Use the right key to highlight the custom 2 tab at the top of the menu.



Use the down key to highlight the date/time-set menu option.



Press the right key. "Enter" will appear on the right side of the menu.



Press the center of the controller to display the date/time setting screen.



Use the left and right keys to select the item to be changed.



Use the up and down keys to adjust the item.



Press the center of the controller to set the clock and calendar. The setup menu will be displayed.

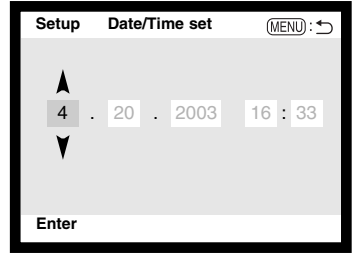

Date/Time setting screen

## Camera notes

For customers in certain areas, the menu language must also be set. Highlight the language option in the basic section of the setup menu. Press the right key to display the language settings. Using the up/down keys, highlight the desired language. Press the center of the controller to set the highlighted language; the setup menu will be displayed in the selected language.

# AUTO-RECORDING MODE

## BASIC OPERATION

This section covers the basic operation of this camera. Thoroughly familiarize yourself with the operations in this section before moving on to the other sections in the manual.

The sophisticated technology employed in the auto-recording mode frees the photographer from complicated camera settings to be able to simply concentrate on the subject and composition. Although automated, the camera's operation can be changed to meet various conditions as well as to suit personal shooting preferences.

### Minolta History



Innovation and creativity has always been a driving force behind Minolta products. The Electro-zoom X was purely an exercise in camera design. It was unveiled at Photokina in Germany in 1966.

The Electro-zoom X was an electronically controlled aperture-priority mechanical SLR with a built-in 30 - 120mm f/3.5 zoom lens giving twenty 12 X 17mm images on a roll of 16mm film. The shutter-release button and battery chamber are located in the grip. Only a few prototypes were built making it one of Minolta's rarest cameras.



## HANDLING THE CAMERA

While using the viewfinder or LCD monitor, grip the camera firmly with your right hand while supporting the body with your left hand. Keep your elbows at your side and your feet shoulder-width apart to hold the camera steadily.

When taking vertical pictures, hold the camera so that the flash is above the lens with the grip to the bottom. Take care not to cover the lens with your fingers or the strap.

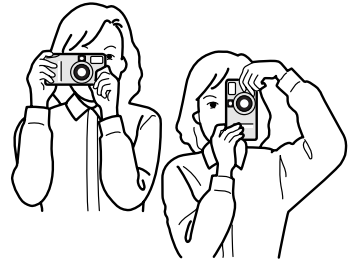

## USING THE ZOOM LENS

This camera is equipped with a 7.15 to 28.6mm optical zoom. This is equivalent to a 35 - 140mm zoom lens on a 35mm camera. In 35mm photography, focal lengths below 50mm are referred to as wide-angle; the angle of view is larger than that of the human eye. Above 50mm is referred to as telephoto and makes distant objects appear closer. The effect of the optical zoom is visible in both the viewfinder and LCD monitor.

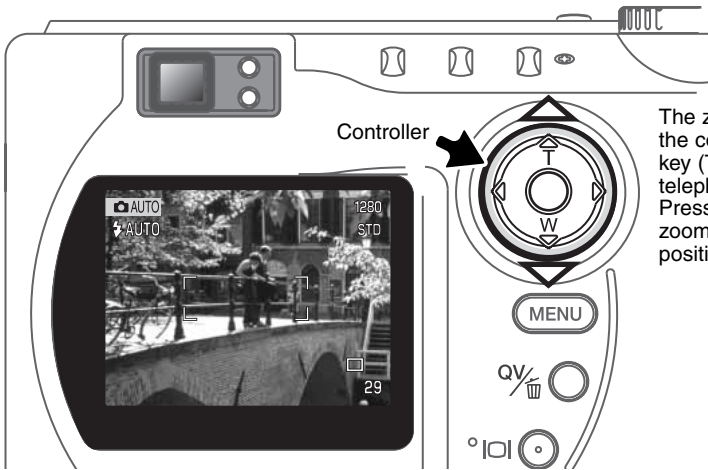

The zoom lens is operated by the controller. Pressing the up key (T) will zoom in to the telephoto position of the lens. Pressing the down key (W) will zoom out to the wide-angle position.



# BASIC RECORDING OPERATION

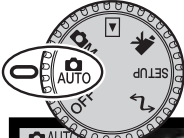

With the mode dial set to auto recording, the camera will be on and the LCD monitor will activate.

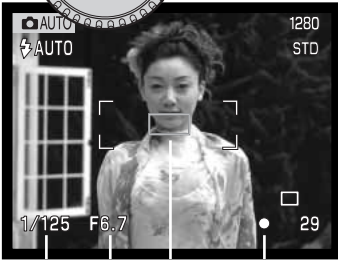

Place the subject within the focus frame.

- The focus-lock function (p. 26) can be used with off-center subjects.
- The subject must be within the focus range of the lens: 0.5m - ∞ (wide-angle position), 0.9m - ∞ (telephoto position). For subjects closer than 0.6m, use the macro function (p. 28).
- If the subject is closer than 1m at the wide-angle lens position or 3m at the telephoto lens position, use the LCD monitor to frame the subject.



Press the shutter-release button partway down (1) to lock the focus and exposure.

- The focus signals (p. 27) on the monitor will confirm the focus. If the focus signal is red, the camera was unable to focus on the subject. Repeat the previous steps until the signal is white.



When the focus is set, an AF sensor will briefly appear on the live image to indicate the point of focus.

- The shutter speed and aperture value will change from white to black indicating the exposure is locked.

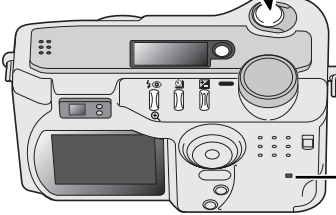

Press the shutter-release button all the way down (2) to take the picture.

- The access lamp will glow indicating image data is being written to the CompactFlash card. Never remove a memory card while data is being transferred.

# FOCUS LOCK

The focus-lock function is used when the subject is off-center and outside the focus frame. Focus lock may also be used when a special focusing situation prevents the camera from focusing on the subject. This function is controlled with the shutter-release button.

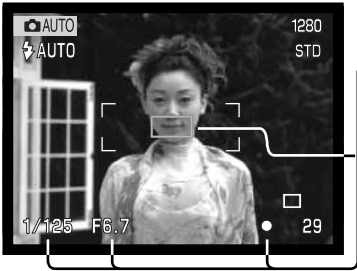

Place the subject within the focus frame. Press and hold the shutter-release button partway down.

- The focus signals will indicate that the focus is locked. The shutter speed and aperture value will change from white to black indicating the exposure is locked.
- When the focus is set, an AF sensor will briefly appear on the live image to indicate the point of focus.



Without lifting your finger from the shutter-release button, re-compose the subject within the image area. Press the shutter-release button all the way down to take the picture.

# FOCUS RANGE

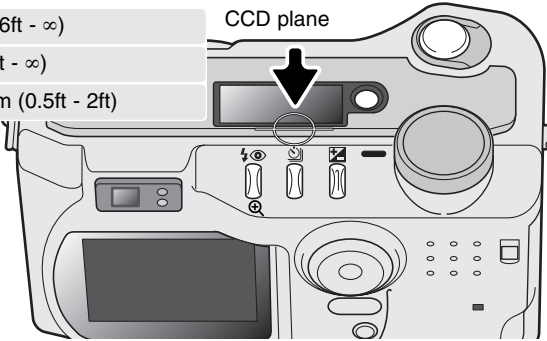

Wide-angle lens position	0.5m - ∞ (1.6ft - ∞)
Telephoto lens position	0.9m - ∞ (3ft - ∞)
Macro mode (p. 28)	0.16m - 0.6m (0.5ft - 2ft)

All distances are measured from the CCD.



# FOCUS SIGNALS

This digital camera has a quick, accurate autofocus system. The focus icon in the lower right corner of the LCD monitor and the green focus lamp next to the viewfinder indicate the focus status.

	Focus icon: white Focus lamp: steady	Focus locked.
	Focus icon: red Focus lamp: blinking	Cannot focus. The subject is too close or a special situation is preventing the AF system from focusing.

- The shutter can be released even if the camera cannot focus on the subject.
- When the AF system cannot focus, the focus is set to infinity. When the flash is in use, the focus is set between 3.0 and 3.8m. In this case, focus lock can be used with an object at the same distance as the main subject or the camera can be focused manually in the multi-function recording mode (p. 59).

# SPECIAL FOCUSING SITUATIONS

The camera may not be able to focus in certain situations. If the autofocus system cannot focus on a subject, the focus icon will turn red. In this situation the focus-lock function can be used to focus on another object at the same distance as your main subject, and then the image can be recomposed to take the picture.

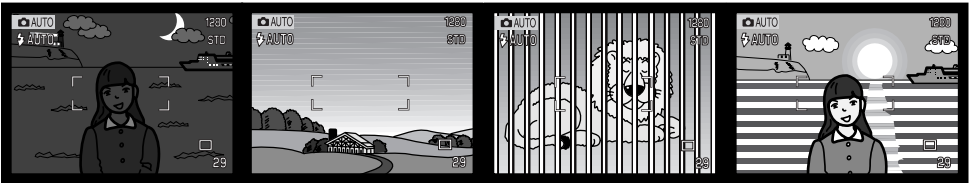

The subject is too dark.

The subject in the focus frame is low in contrast.

Two subjects at different distances overlap in the focus frame.

The subject is near a very bright object or area.

## DIGITAL-SUBJECT-PROGRAM BUTTON

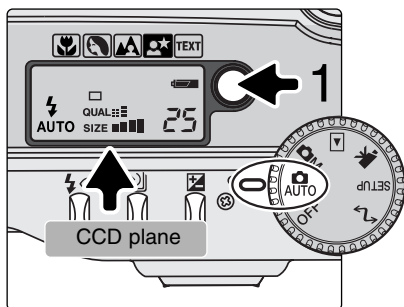

The digital-subject-program button (1) optimizes the camera's exposure, white-balance, and image-processing systems for various conditions and subjects. Pressing the subject-program button cycles through the modes: macro, portrait, landscape, night portrait, text, macro & text, and the original exposure mode. A pointer will indicate the active subject program. The subject program will remain in effect until it is changed or the mode dial is turned to another position. Except for macro, digital subject programs cannot be used in the multi-function recording mode.

While subject programs optimize camera performance for each shooting condition, some changes can be made to camera settings. The flash mode (p. 30) can be changed and the exposure can be altered using the exposure-compensation function (p. 50). In extreme lighting conditions, changes in exposure compensation may not produce the intended results in the portrait, night portrait, or text modes. The camera-shake warning (p. 31) may appear in macro, landscape, night portrait, or text modes.



**MACRO** - used for close-up photography between 16 and 60 cm (6 ~ 24in.) from the CCD. When the macro mode is selected, the lens will automatically zoom to the correct position. The zoom position cannot be changed. The LCD monitor should be used to compose the picture and will automatically activate if off. The viewfinder cannot be used because of parallax. The flash is set to flash cancel (p. 30). Fill-flash can be used, but can cause extreme overexposure and uneven illumination.

This subject program can be used in the multi-function recording mode. It will not reset if the position of the mode dial is changed.



**PORTRAIT** - optimized to reproduce soft skin tones and a slight defocusing of the background. The flash mode can be changed (p. 30). Most portraits look best at a telephoto setting; longer focal lengths do not exaggerate facial features and the shallower depth of field softens the background.



**LANDSCAPE** - optimized to produce sharp, colorful landscapes. The flash mode is set to flash cancel. Fill-flash can be used (p. 30).



**NIGHT PORTRAIT** - for deep, subtle night scenes. When used with fill-flash, the subject and background exposures are balanced. When taking pictures of a landscape at night, use a tripod to eliminate blurring from camera shake. To take portraits with night scenes, set the flash mode to fill-flash (p. 30). Ask your subject not to move after the flash burst; the shutter will still be open for the background exposure.

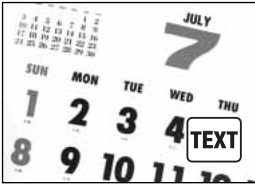

**TEXT** - for the crisp reproduction of black text or line art on white backgrounds. The flash mode is set to flash cancel (p. 30). Fill-flash can be used. Use a tripod to eliminate camera shake and ensure the sharpest images.

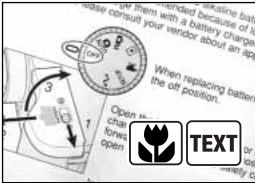

**MACRO & TEXT** - for close-up images of text or line art between 16 - 60cm (6 ~ 24in.) from the CCD. Two pointers will indicate the combined modes on the data panel and the macro and text indicators will be displayed on the monitor. The use of a tripod is recommended. The flash is set to flash cancel. Fill-flash can cause extreme overexposure and uneven illumination.

# FLASH MODES

To set the flash mode, simply press the flash mode button (1) on the back of the camera until the desired mode is displayed.

**Autoflash** - the flash fires automatically in low-light and backlit conditions.

**Fill-flash** - the flash fires with each exposure regardless of the amount of ambient light. Fill-flash can be used to reduce harsh shadows caused by strong direct light or sunshine.



**Flash cancel** - the flash will not fire. Use flash cancel when flash photography is prohibited, natural light is desired to illuminate the subject, or the subject is beyond the flash range. The camera-shake warning may appear when flash cancel is selected (p. 31).

**Red-eye reduction** - the flash fires twice before the main flash burst to reduce red-eye; an effect caused by light reflected from the retina. Use in low-light conditions when taking photographs of people or animals. The pre-flashes contract the pupils of the subject's eyes.

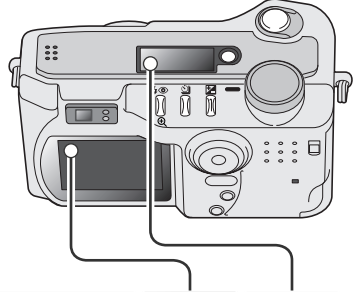
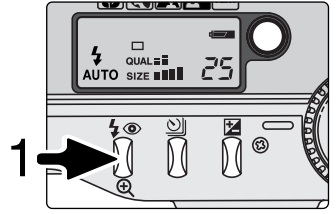

Autoflash		
Fill-flash		
Flash cancel		
Autoflash with red-eye reduction		
Fill-flash with red-eye reduction		

## FLASH RANGE - AUTO-RECORDING MODE

The camera will automatically control the flash output. For well-exposed images, the subject must be within the flash range. Because of the optical system, the flash range is not the same at the lens' wide-angle position as it is at the telephoto position.

Wide-angle position	0.5m ~ 3.5m (1.6 ft. ~ 11.5 ft.)
Telephoto position	0.9m ~ 3.0m (3.0 ft. ~ 9.8 ft.)

At the wide-angle lens position, when using the flash with subjects closer than 1m (3ft.), vignetting can occur. A slight shadow or shading may be apparent at the bottom of a horizontal image.

## FLASH SIGNALS

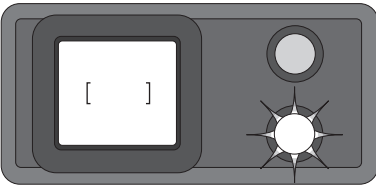

The orange flash lamp next to the viewfinder indicates the status of the flash. When the lamp glows steadily, the flash is charged and ready to fire. When the lamp blinks quickly, the flash is charging and the shutter will not release. The flash lamp is also used as a camera-shake warning, see below.

## CAMERA-SHAKE WARNING

If the shutter speed falls below the point where the camera can be safely hand held, the camera-shake warning will appear on the LCD monitor and the orange focus lamp will blink slowly. Camera shake is slight blurring caused by subtle hand motion and is more pronounced at the telephoto setting of the lens than at the wide-angle setting. Although the warning appears, the shutter can still be released. If the warning appears, the following steps can be taken:

- Place the camera on a tripod.
- Use the built-in flash.
- Zoom the lens towards the wide-angle position until the warning disappears.



# DRIVE MODES

The drive modes control the rate and method images are captured. Icons indicating the selected drive mode appear on the data panel and LCD monitor.

To change the drive mode, simply press the drive-mode button (1) on the back of the camera until the desired mode is displayed.

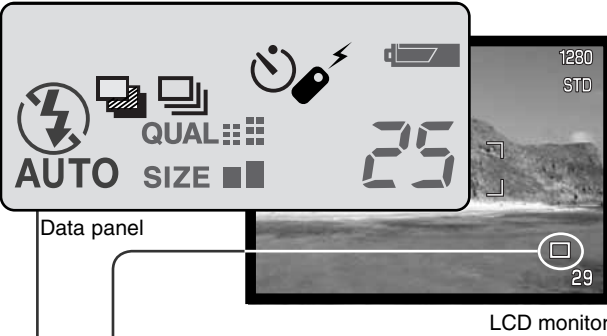
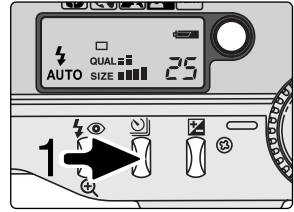

All drive-mode indicators have been shown for clarity. The single-frame advance and continuous drive indicators occupy the same area of the data panel. All the drive-mode icons appear in the lower right corner of the monitor.

		Single-frame advance	To take a single image each time the shutter-release button is pressed (p. 25).
		Self-timer/ Remote control	To delay the release of the shutter. Used for self-portraits.
		Continuous advance	To take multiple images when the shutter-release button is pressed and held.
		Bracketing	To take a series of three images with differing exposures.



## SELF-TIMER

Used for self-portraits, the self-timer will delay the release of the shutter for approximately ten seconds after the shutter-release button is pressed. The self-timer is set with the drive-mode button (p. 32).

With the camera on a tripod, compose the picture as described in the basic recording operation section (p. 25). Focus lock ( 26) can be used with off-center subjects. Press the shutter-release button partway down to lock the exposure and focus (1). Press the shutter-release button all the way down to begin the countdown (2). Because focus and exposure are determined when the shutter-release button is pressed, do not stand in front of the camera when taking a self-timer image. Always confirm the focus with the focus signals before beginning the countdown (p. 27).

During the countdown, the self-timer lamp on the front of the camera (3) will start to blink and is accompanied by an audio signal. A few seconds before the exposure, the self-timer lamp will blink rapidly. The lamp will glow steadily just before the shutter fires. To stop the countdown, press the drive-mode button.

The self-timer is canceled after the exposure. The audio signal can be turned off in the custom 1 section of the setup menu (p. 84).

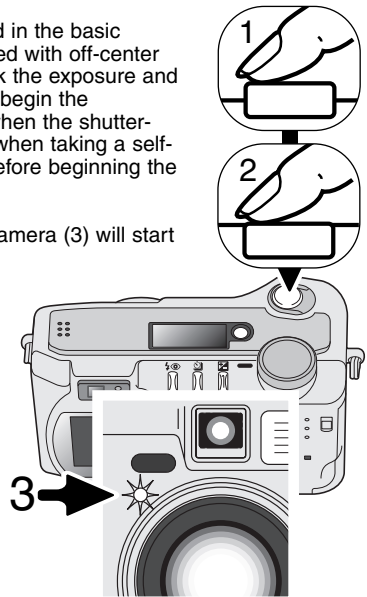

### Shooting tips

The self-timer can be used to minimize camera shake with long exposures. When using the camera on a tripod, photographs of static subjects (landscapes, still-lives, or close-up photographs) can be made with the self-timer. Because no contact is made with the camera during exposure, there is no risk of camera shake caused by the operator.

## REMOTE CONTROL (SOLD SEPARATELY)

The IR Remote Control RC-3 allows remote camera operation up to 5m (16 ft.) away. The remote control unit can be used in movie recording (p. 68).

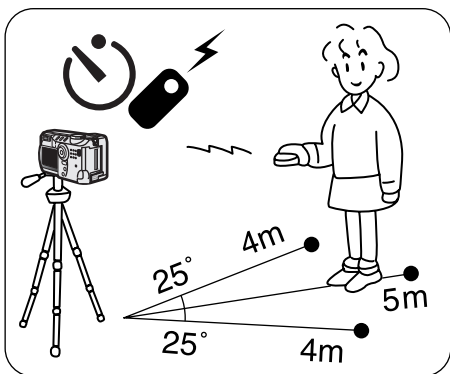

Place the camera on a tripod, and set the drive mode to self-timer / remote control (p. 32).

Arrange the camera and subject to compose the picture. Frame the subject within the focus frame when setting up the camera.

Focus lock cannot be used with the IR remote control. In multi-function recording mode, focus area selection can be used for off-center subjects (p. 52).

While pointing the emitter window of the remote control unit toward the camera, press the release button or the delay button to take the picture. When the release button is pressed, the self-timer lamp on the front of the camera will blink once before the picture is taken. When the delay button is pressed, the self-timer lamp on the front of the camera will blink for two seconds before the picture is taken.

The drive mode does not reset after the exposure so multiply images can be captured. The remote control may not operate with backlit subjects or under fluorescent light.

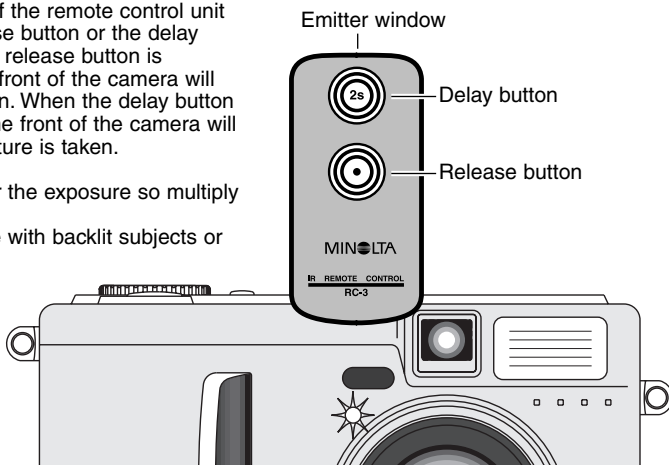

## CONTINUOUS ADVANCE

The continuous-advance drive mode allows a series of images to be captured while holding down the shutter-release button. Continuous advance acts like a motor drive on a film camera. The number of images that can be captured at one time and the rate of capture depend on the image-quality and image-size setting. The maximum rate of capture is 1.6 fps. The continuous-advance mode is set with the drive-mode button (p. 32).

When the shutter-release button is pressed and held, the camera will begin recording images until the maximum number has been taken or the shutter button is released. This mode cannot be used with TIFF images (p. 44). The built-in flash can be used, but the rate of capture is reduced because the flash must recharge between frames.

Compose the picture as described in the basic recording operation section (p. 25). Press the shutter-release button partway down (1) to lock the exposure and focus for the series. Press and hold the shutter-release button all the way down (2) to begin taking pictures.

The following chart lists the approximate maximum number of images that can be captured with different image-quality and image-size combinations.

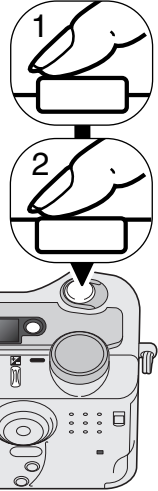

Quality \ Size	2272 X 1704	1600 X 1200	1280 X 960	640 X 480
Fine	6	10	15	33
Standard	9	16	23	43
Economy	14	24	31	53

## BRACKETING

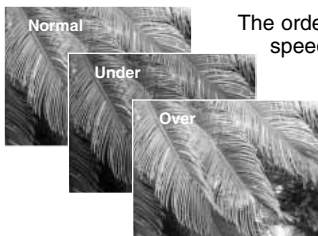

This drive mode makes a three-image bracket of a scene. Bracketing is a method of taking a series of images of a static subject in which each image has a slight variation in exposure. The bracketing mode is set with the drive-mode button (p. 32). Brackets cannot be made with TIFF images (p. 44).

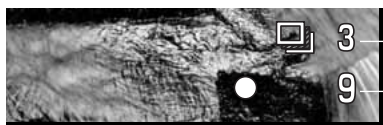
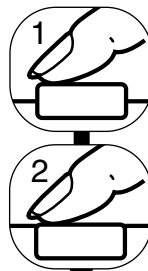

The order of the bracket series is normal exposure (as indicated by the shutter speed and aperture displays), underexposure, and overexposure. The exposure bracket in auto-recording mode is set to 0.5 Ev increments. In the multi-function recording mode the increment can be set to 0.3, 0.5, or 1.0 Ev increments in the custom 1 section of the menu (p. 54).

Compose the picture as described in the basic recording operation section (p. 25). Press the shutter-release button partway down (1) to lock the exposure and focus for the series. Press and hold the shutter-release button all the way down (2) to make the bracket series; three consecutive images will be captured. If the memory card is filled or the shutter button is released before the series has completed, the camera will reset and the entire bracket must be made again. When using flash, there will be a delay between frames as the flash charges. The remaining number of frames in the bracket series is displayed on the monitor next to the bracketing icon.



-  3 — Number of frames in bracketing series
-  9 — Frame counter

When using exposure compensation (p. 50), the bracketing series will be made in relation to the compensated exposure. Under extreme conditions, one of the bracketed exposures may be inaccurate because it is outside the exposure control range of the camera.

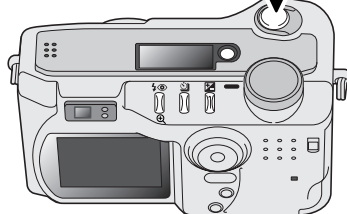

## DISPLAY BUTTON - RECORDING MODE

The display button controls the LCD monitor display. The display cycles to the next position each time the button is pressed: standard display, focus frame only, real-time histogram, live image only, and monitor off. The number of screens and their formats can be changed in the basic section of the setup menu (p. 84)

Battery power can be conserved by turning the monitor off and using the viewfinder to take pictures. When the menu or exposure-compensation button is pressed, or the macro mode is activated, the monitor will automatically turn on. Full-time AF (p. 63) and the digital zoom (p. 48) are disabled when the monitor is off.

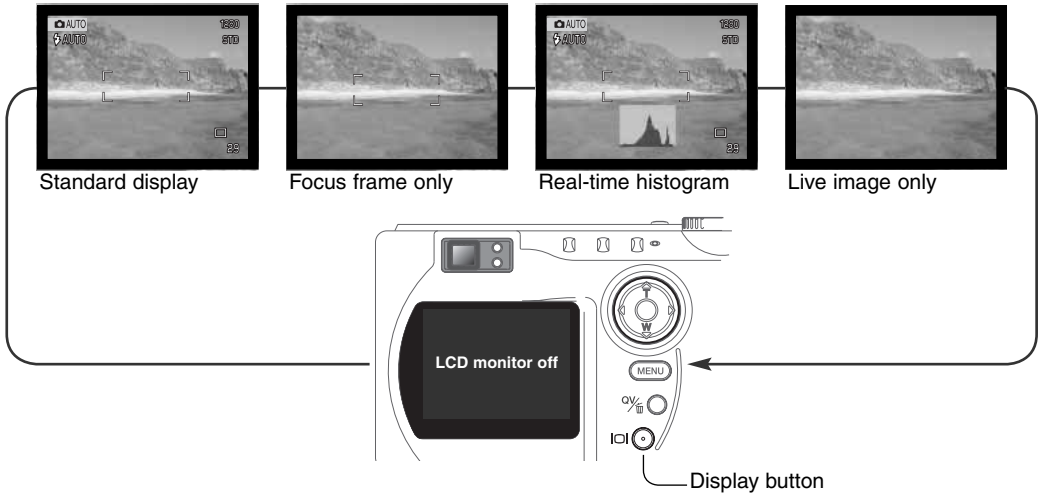

The real-time histogram shows the approximate luminance distribution of the live image. The histogram is not accurate when the monitor image is amplified in low-light conditions, or when the camera is focusing. The histogram of the recorded image may not have the same distribution as the real-time histogram.

# PLAYBACK - BASIC OPERATION

Images can be viewed in the Quick View or playback modes. This section covers the basic operations in both modes. The playback mode has additional functions, see page 70.

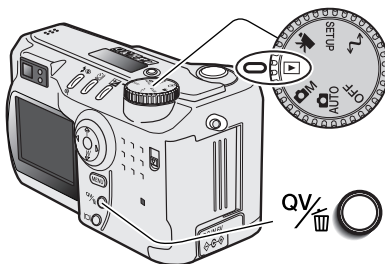

To view images from the playback mode, turn the mode dial to the playback position.

To view images from the auto-recording, multi-function recording, or movie recording modes, press the Quick View / delete button.

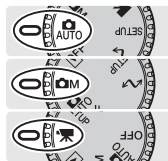

## SINGLE-FRAME PLAYBACK AND HISTOGRAM DISPLAY

The diagram shows a camera's playback screen with various settings and indicators. The main screen displays a landscape image with the following information:

- Mode indicator:
- Image size: 1280
- Image quality: STD
- Time of capture: 14:20
- Date of capture: 04.27.2003
- Voice-memo indicator:
- Lock indicator:
- Print indicator:
- Frame number/ total number of images: [0029/0078]

The histogram display shows the following information:

- Aperture value: F3.0
- Shutter speed: 1/1000
- White-balance setting: AWB
- Sensitivity setting: ISO400
- Degree of exposure compensation: 0
- Folder name: MLT24
- Folder number - image file number: 100-0003

The histogram itself shows a distribution of light and dark tones.



To view the histogram of the displayed still image, press the up key. The histogram shows the luminance distribution of the image from black (left) to white (right). The 224 vertical lines indicates the relative proportion of that light value in the image. The histogram can be used to evaluate exposure, but displays no color information. To return to single-frame playback, press the down key.

## VIEWING AND DELETING IMAGES



In Quick View or the playback mode, use the left/right keys of the controller to scroll through the images.

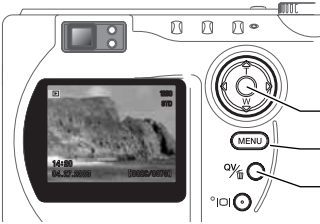

To return to the recording mode from Quick View, press the menu button or shutter-release button partway down.

Controller

Menu button

Quick View / Delete button

The displayed image can be deleted. Once deleted, an image cannot be recovered.



To delete the displayed image, press the QV/delete button. A confirmation screen will appear.



Use the left/right keys to highlight "Yes." "No" will cancel the operation.



Press the center of the controller to delete the image.



## DISPLAY BUTTON - PLAYBACK

The display button controls the display format. Each time the button is pressed, the display cycles through to the next format: full display, image only, index playback.

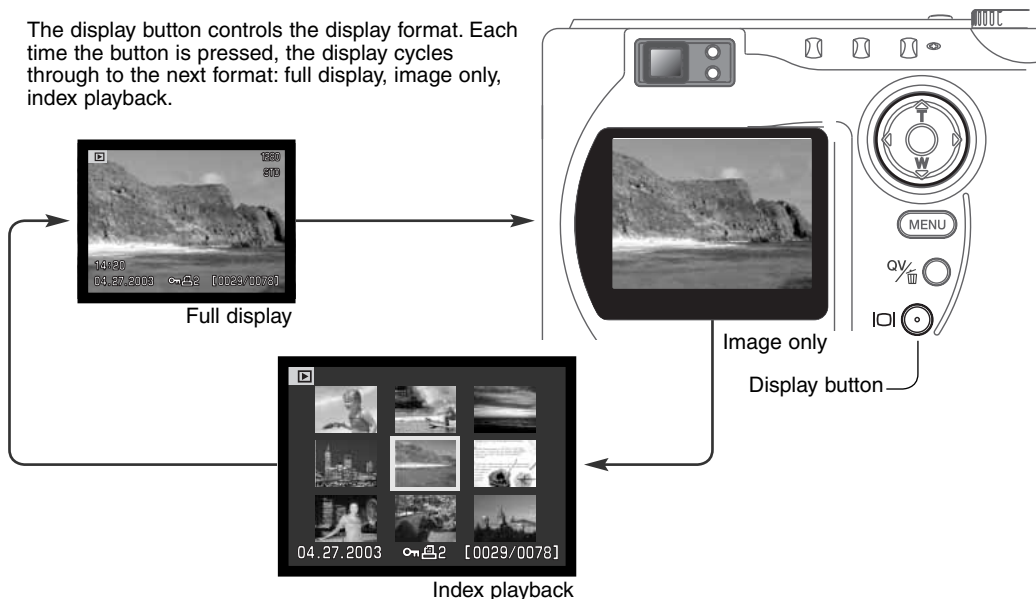

In index playback, the left/right keys of the controller will move the yellow border to the next or the previous image. When the image is highlighted with the border, the date of recording, voice memo indicator, the lock and printing status, and the frame number of the image are displayed at the bottom of the screen. The highlighted image can be deleted using the QV/delete button (p. 39), or an accompanying voice memo can be played by pressing the controller (p. 70). When the display information button is pressed again, the highlighted image will be displayed in the single-frame playback mode. A nine or four image index can be displayed. The index-playback format can be changed in the basic section of the playback-mode menu (p. 72).



# ENLARGED PLAYBACK

In single-frame playback, a still image can be enlarged up to 3.5X in 0.2X increments for closer examination. 640 X 480 size images can only be enlarged between 1.2X and 2.0X. The maximum enlargement of 1024 X 768 digital zoom images is 3.2X. TIFF images cannot be enlarged.



With the image to be magnified displayed, press the magnification button (1) to activate the enlarged playback mode. The degree of magnification is displayed on the LCD monitor.

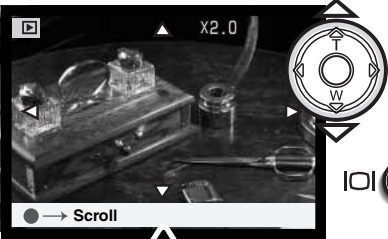

Pressing the up key increases the image magnification. Pressing the down key decreases the magnification.

 The display button switches between showing the full display and the image only.

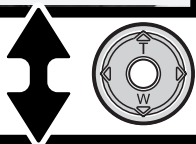

To scroll the image, press the center of the controller; the button switches between the enlarged-playback and scroll screens.

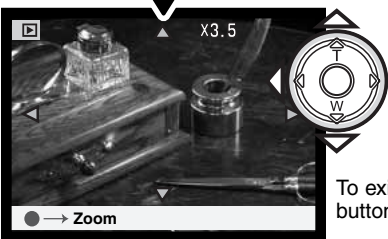

Use the four-way keys of the controller to scroll the image.

To exit the enlarged playback mode, press the magnification button (1).

# AUTO-RECORDING MODE - ADVANCED OPERATION

## NAVIGATING THE AUTO-RECORDING MODE MENU

In auto-recording mode, press the menu button (1) to activate the menu. The menu button also turns off the menu after settings are made. The four-way keys of the controller (2) are used to move the cursor in the menu. Pressing the center of the controller will enter a setting.



Use the up/down keys of the controller to scroll through the menu options. Highlight the option whose setting needs to be changed. When scrolling in one direction, the cursor will jump between the top and bottom of the menu.



With the menu option to be changed highlighted, press the right controller key; the settings will be displayed with the current setting highlighted. To return to the menu options, press the left key.



Use the up/down keys to highlight the new setting.



Press the center of the controller to select the highlighted setting.

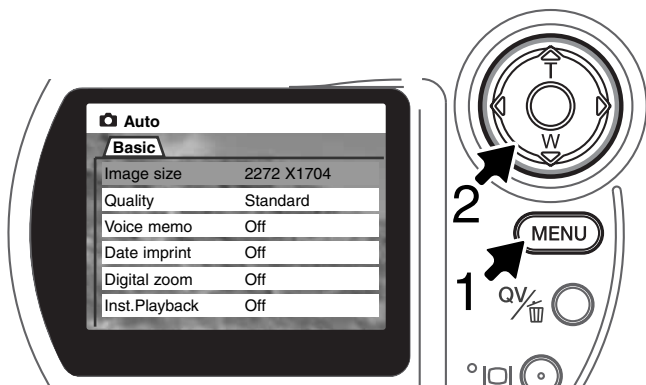

Once a setting has been selected, the cursor will return to the menu options and the new setting will be displayed. Changes can continue to be made. To return to the auto-recording mode, press the menu button.

Changes made on the auto-recording mode menu will also affect the multi-function recording mode.

Basic	
Image size	2272 X 1704
	1600 X 1200
	1280 X 960
	640 X 480
Quality	TIFF
	Fine
	Standard
	Economy
Voice memo	15 sec.
	5 sec.
	Off
Date imprinting	On
	Off
Digital zoom	On
	Off
Inst.Playback	10 sec.
	2 sec.
	Off

Settings made with the auto-recording menu will remain in effect until changed or the camera is reset to its default settings (p. 90).

**Image size** - To set the pixel resolution of the images. Image size affects the size of the image file.

**Image quality** - To set the rate of compression of the images. Image quality affects the size of the image file.

**Voice memo** - To record audio after a still image has been captured. The function can be turned off and the length of the recording can be set.

**Date imprint** - The date of recording can be imprinted on each image. The date is set in the custom 2 section of the setup menu (p. 20).

**Digital zoom** - The digital zoom can be turned on or off.

**Instant playback** - After taking a picture, the image will be displayed on the monitor for two or ten seconds. The displayed image can be deleted before being saved to the CompactFlash card.

Read the following sections for more details on these options and settings. All of these functions appear on the multi-function recording mode menu (p. 54).

## IMAGE SIZE AND IMAGE QUALITY

Changing image size affects the number of pixels in each image. The greater the image size, the larger the file size. Choose image size based on the final use of the image - smaller images will be more suitable for web sites whereas larger sizes will produce higher quality prints.

Data panel	LCD monitor	Number of pixels (hor. X vert.)
SIZE ■■■■	2272	2272 X 1704
SIZE ■■■	1600	1600 X 1200
SIZE ■■	1280	1280 X 960
SIZE ■	640	640 X 480

Image quality controls the rate of compression, but has no effect on the number of pixels in the image. The higher the image quality, the lower the rate of compression and the larger the file sizes. If economical use of the memory card is important, use the economy mode. Standard image quality is sufficient for normal usage. The TIFF mode will produce the highest quality image and the largest image files. A status bar is displayed when large images are saved.

Data panel	LCD monitor		File type
QUAL ■■■■	TIFF	TIFF - the highest quality image.	TIFF
QUAL ■■■	FINE	Fine - high-quality image.	JPEG
QUAL ■■	STD.	Standard - the default setting.	JPEG
QUAL ■	ECON.	Economy - the smallest file sizes.	JPEG

File formats vary with the image quality setting. The fine, standard, and economy settings are formatted as a JPEG file. TIFF, fine, standard, and economy files can be recorded as color or monochrome images (p. 64) in the multi-function recording mode.

Image size and quality must be set before the picture is taken. Changes are displayed on the data panel and LCD monitor. Image size and quality must be reset manually. See navigating the auto-recording mode menu section on page 42. In multi-function recording mode, image size and quality are controlled in the basic section of the multi-function recording menu (p. 54).

If image size or quality are changed, the frame counter will display the approximate number of images that can be recorded at that setting on the installed memory card. One memory card can contain images with differing sizes and qualities. The number of images that can be stored on a memory card is determined by the size of the card and the file size of the images. The actual file size is determined by the scene; some subjects can be compressed further than others.

Approximate file sizes.				
Quality \ Size	2272 X 1704	1600 X 1200	1280 X 960	640 X 480
TIFF	12MB	5.7MB	3.7MB	1.0MB
Fine	2MB	1.0MB	720KB	320KB
Standard	1.2MB	650KB	460KB	240KB
Economy	750KB	430KB	330KB	190KB
Approximate number of images that can be stored on a 16MB memory card.				
TIFF	1	2	3	13
Fine	6	12	17	34
Standard	11	19	26	42
Economy	17	27	33	48

### Camera Notes

The frame counter indicates the approximate number of images that can be stored on the memory card at the camera's image quality and size settings. If the settings are changed, the frame counter adjusts accordingly. Because the counter uses approximate file sizes, the actual image taken may not change the counter or may decrease it by more than one. When the frame counter displays zero, it indicates no more images at the image size and quality settings can be captured. Changing those settings may allow more images to be saved to the card.

## VOICE MEMO

Voice memo allows a five or fifteen second audio track to be recorded with a still image. The function is activated and the length of the recording time is set on the auto-recording mode menu (p. 42). In multi-function recording mode, voice memo is controlled in the custom 2 section of the multi-function recording menu (p. 54). When the function is active, the microphone icon is displayed on the data panel and LCD monitor. The voice memo must be set before taking a picture. It will remain in effect until reset.

After an image is captured, a screen will appear indicating the audio recording has started. A bar graph (1) will display the amount of recorded time remaining. The recording will automatically stop when the set time has elapsed. To cancel the recording and erase the audio track, press the down key of the controller (2) or the shutter-release button (3) before the recording has finished.

The voice memo is attached to the last frame in a continuous-advance or bracketing series (p. 32). The voice memo can be played back in Quick View or in the playback mode (p. 70). Images with voice-memo audio tracks have a note icon displayed with them.

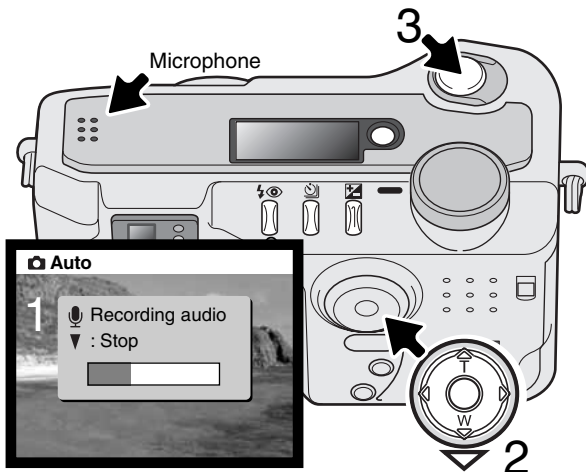

### Recording Tips

When making audio recordings, be careful not to touch or cover the microphone. The quality of the recording is proportional to the subject to microphone distance. For best results, hold the camera approximately 20cm (8in) from your mouth.

## DATE IMPRINTING

The date of recording can be printed directly on the image. The imprinting function must be activated before the image is taken. Once activated, the date will continue to be imprinted until the function is reset; a yellow bar is displayed behind the frame counter on the monitor to indicate date imprinting is active.

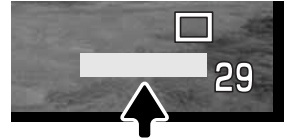

Date-imprinting indicator

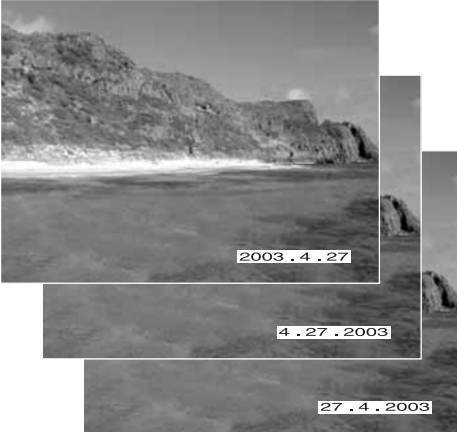

Date imprinting is activated with a menu; see navigating the auto-recording mode menu section on page 42. In multi-function recording mode, date imprinting is controlled in the custom 2 section of the multi-function recording menu (p. 54).

The date is imprinted in the lower right corner of the image when viewed horizontally. It is printed directly on the photograph writing over the image information. The date can be imprinted in three formats: year/month/day, month/day/year, and day/month/year. The date and date format are set in the custom 2 section of the setup-mode menu (p. 84).

### Camera Notes

Every time a still image is recorded, it is stored with an exif tag that contains the date and time of recording as well as shooting information. This information can be viewed with the camera in the playback or Quick View mode, or on a computer with the DiMAGE Viewer software.

# DIGITAL ZOOM

Assisting the optical zoom is a 2.2X digital zoom. The effect of the digital zoom doubles the power of the telephoto position of the optical zoom giving the equivalent of a 308mm lens on a 35mm camera. The effect is visible on the LCD monitor only. The digital-zoom is canceled if the LCD monitor is turned off (p. 37). The digital zoom is activated in the auto-recording menu (p. 42). In the multi-function recording mode, it is activated in the custom 1 section of the multi-function recording mode menu (p. 54).

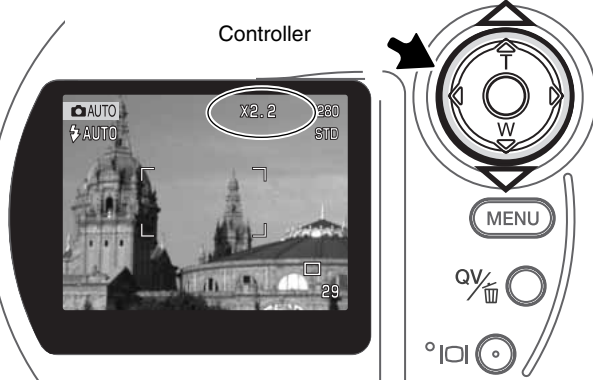

At the maximum telephoto position, press the up key (T) to activate the digital zoom. X2.2 will be displayed in the top right corner of the monitor.

To cancel the digital zoom, press the down key.

When an image is taken with the digital zoom, the final image size depends on the image-size setting on the camera, see chart.

	Image size setting			
	2272 X 1704	1600 X 1200	1280 X 960	640 X 480
Size of recorded image	1024 X 768	1024 X 768	1024 X 768	640 X 480



## INSTANT PLAYBACK

After an image is captured, it can be displayed on the monitor before being saved. An index display is used with the continuous-advance or bracketing drive modes (p. 32). When used with voice memo, the audio recording begins after the image is played back.

Instant playback is activated with a menu; see navigating the auto-recording mode menu section on page 42. Instant playback is also set in the custom 2 section of the multi-function recording menu (p. 54). There are three menu settings:

Off	Instant playback is disabled.
2 sec	The captured image will be displayed for two or ten seconds. While displayed, the image can be deleted before being saved.
10 sec	

### To store an image during playback.



If the center of the controller is pressed during the instant playback, the displayed image will immediately be saved and the playback canceled.

### To delete an image.

To delete an image during the instant playback, press the QV/delete button (1). A confirmation screen will appear.



Use the left/right keys of the controller to highlight "YES." "NO" will cancel the operation.



Press the controller to delete the image.

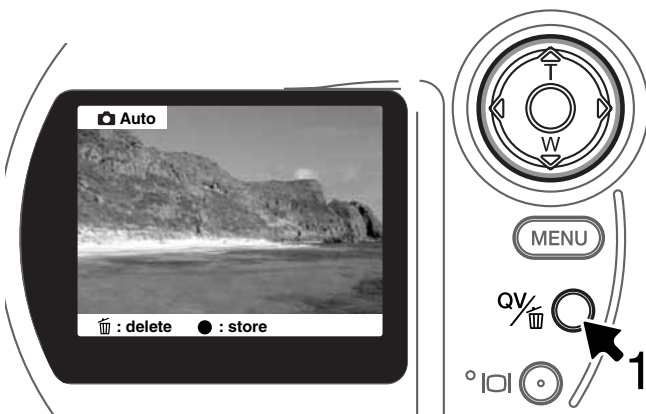

## EXPOSURE COMPENSATION

The camera exposure can be adjusted to make the final picture lighter or darker by as much as  $\pm 2\text{Ev}$  in  $1/3$  increments. In auto-recording mode, exposure compensation is reset when the mode dial is moved to another position. The exposure-compensation value will remain in effect until it has been reset in the multi-function recording mode.

The exposure compensation must be set before the image is captured. When setting the exposure compensation, the amount of compensation is shown next to the exposure-compensation indicator on the monitor. After the setting is made, the shutter-speed and aperture displays will indicate the actual exposure. Because the exposure can be adjusted in fine steps, the shutter speed or aperture value displayed may not change. When set to any value other than 0.0, the exposure-compensation indicator will remain on the data panel and LCD monitor as a warning.

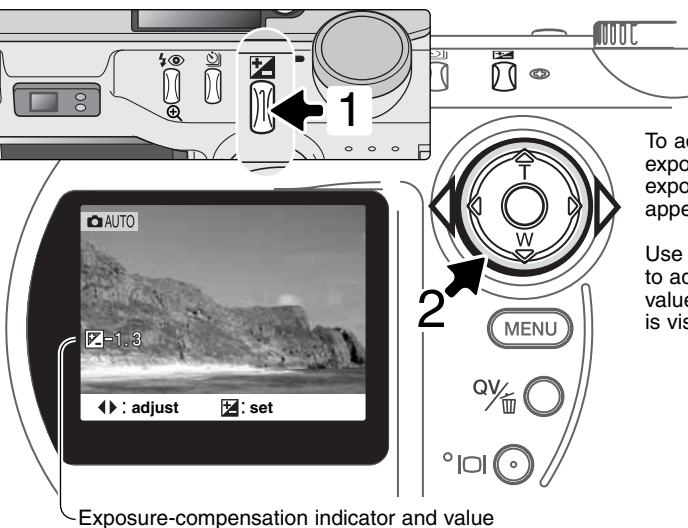

To adjust the exposure, press the exposure-compensation button (1). The exposure compensation screen will appear.

Use the left/right keys of the controller (2) to adjust the exposure-compensation value. Change in exposure compensation is visible in the live image on the monitor.

Exposure-compensation indicator and value

## Shooting tips

Sometimes the camera's exposure meter is deceived by certain conditions. Exposure compensation can be used in these situations. For example, a very bright scene, such as a snowy landscape or a white sandy beach, can appear too dark in the captured image. Before taking the picture, adjusting the exposure by +1 or +2 EV will result in an image with normal tonal values.



Calculated camera exposure



-1.0Ev



-2.0Ev

In the example above, the dark water caused the camera to overexpose the image making it bright and washed-out. By compensating the exposure, detail is brought out in the leaves, and the stones and water appear richer.

## WHAT IS AN EV? WHAT IS A STOP?

Ev stands for exposure value. The term stop comes from the name of aperture plates used in early lenses. A change of one Ev or one stop will adjust the exposure calculated by the camera by a factor of two.

Change in Ev	Change in stops	Adjustment to exposure
+2.0 Ev	+2 stops	4X as much light
+1.0 Ev	+1 stop	2X as much light
0.0 Ev	Calculated exposure	
-1.0 Ev	-1 stop	1/2 as much light
-2.0 Ev	-2 stops	1/4 as much light

# MULTI-FUNCTION RECORDING MODE

Except for digital subject programs, the basic operation of the camera in multi-function recording mode is identical to the auto-recording mode. Thoroughly familiarize yourself with the previous sections before moving on.

The multi-function recording mode allows greater flexibility over image making. This recording mode gives more control over autofocus and composition. The menu controls are extensive allowing critical adjustments to image qualities such as color, sharpness, and contrast. Unlike the auto-recording mode, settings made in multi-function recording are not reset when the position of the mode dial is changed.

## AUTOFOCUS AREAS AND CONTROL

In the multi-function recording mode, the controller selects the focus area used. The wide focus area and focus area selection allow flexibility in a variety of situations.

The wide focus area is an array of local focus areas that work together to control focus. This system is especially effective with moving subjects or quick shooting in fast-moving events. When focus locks, one of the AF sensors within the wide focus area will briefly indicate the point of focus.



Switching between the wide focus area and the spot focus areas is simple. Press and hold the controller until the wide-focus-area frame lines change to the spot-focus-area display. Press and hold the controller again to return to the wide-focus-area frame lines.



The focus area selection controls which spot focus area is active. This function can be used for off-center subjects or to single out an individual subject from a group.

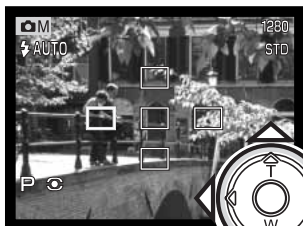

Press and hold the controller to display the spot focus areas; the active area is blue. Use the four-way key of the controller to highlight the desired autofocus area.



Press the shutter-release button partway down (1) or press the center of the controller (2) to select the area; the other four areas will disappear.



2

Once a spot focus area is selected, it will remain active even after the picture has been taken. Only when one focus area is displayed, can the controller be used to zoom (p. 24) or adjust the exposure (p. 56).

To select another focus area, press the center of the controller; all five areas should be displayed. The controller can now be used to change the spot focus area. The selected focus area selection remains in effect when the LCD monitor is turned off.

## NAVIGATING THE MULTI-FUNCTION RECORDING MODE MENU

In multi-function recording mode, press the menu button (1) to activate the menu. The menu button also turns off the menu after making settings. The four-way keys of the controller (2) are used to move the cursor in the menu. Pressing the center of the controller will enter a setting.



Activate the recording-mode menu with the menu button. The **BASIC** tab at the top of the menu will be highlighted. Use the left/right keys of the controller to highlight the appropriate menu tab; the menus will change as the tabs are highlighted.



When the desired menu section is displayed, use the up/down keys to scroll through the menu options. Highlight the option whose setting needs to be changed. When scrolling in one direction, the cursor will jump between the top and bottom of the menu.



With the menu option to be changed highlighted, press the right controller key; the settings will be displayed with the current setting highlighted. To return to the menu options, press the left key.



Use the up/down keys to highlight the new setting.



Press the controller to select the highlighted setting.

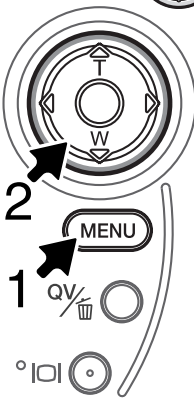

Once a setting has been selected, the cursor will return to the menu options and the new setting will be displayed. Changes can continue to be made. To return to the recording mode, press the menu button. Changes made to image size, image quality, voice memo, date imprint, digital zoom, and instant playback will affect the auto-recording mode.

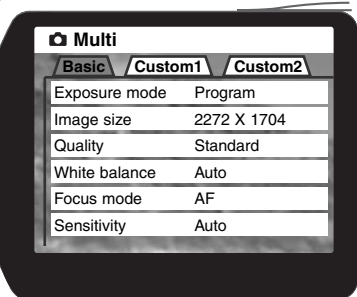

Basic	
Exposure mode	Program
	Aperture priority
	Manual
Image size	2272 X 1704
	1600 X 1200
	1280 X 960
	640 X 480
Quality	TIFF
	Fine
	Standard
	Economy
White balance	Cloudy
	Daylight
	Auto
	Tungsten
	fluorescent
	Custom
Focus mode	AF
	MF
Sensitivity	ISO 400
	ISO 200
	ISO 100
	ISO 64
	Auto

Custom 1	
Full-time AF	On / Off
Metering mode	Multi-segment
	Spot
	1.0 Ev
Exposure bracket	0.5 Ev
	0.3 Ev
	On / Off
Digital zoom	On / Off
Instant playback	10 sec.
	2 sec.
	Off
Custom 2	
Color mode	Vivid Color
	Natural Color
	B&W
	Sepia
	Solarization
Sharpness	Hard (+)
	Normal
	Soft (-)
Contrast	High (+)
	Normal
	Low (-)
Filter	Warm (+)
	Off
	Cool (-)
Voice memo	15 sec.
	5 sec.
	Off
Date imprinting	On
	Off

Refer to the auto-recording mode section for details on image size (p. 44), image quality (p. 44), voice memo (p. 46), date imprinting (p. 47), digital zoom (p. 49), and instant playback (p. 49).

# EXPOSURE MODES

The three exposure modes allow extensive control over image making: program, aperture priority, and manual exposure. Exposure modes are set in the basic section of the multi-function recording mode menu (p. 54).

## Program

The program exposure mode controls both the shutter speed and aperture to ensure perfect exposures. The sophisticated exposure system allows the photographer the freedom to shoot without having to worry about the technical details of exposure settings. The shutter speed and aperture values of the exposure are displayed on the monitor. If shutter speed and aperture displays turn red, the scene is beyond the exposure control range of the camera.

## Aperture priority - A

The photographer selects the aperture and the camera sets the appropriate shutter speed to ensure correct exposure. When aperture priority is selected, the aperture value on the monitor turns blue and a double arrow icon appears next to it. If the LCD monitor is turned off, the aperture value is fixed at the last setting and cannot be changed. The flash mode is set to flash cancel. Fill-flash can be selected (p. 30).

Use the left/right keys of the controller (1) to set the desired aperture value. Press the shutter-release button to activate the exposure system; the corresponding shutter speed will be displayed on the monitor.

The aperture value can be changed in two steps: f/3.0 and f/6.7 at the lens' wide-angle position, f/3.6 and f/8.0 at the lens' telephoto position. As the lens is zoomed, the aperture will automatically shift. If the aperture value is beyond the shutter-speed range, the shutter-speed display will turn red on the monitor. For more on the aperture and image control, see page 66.





## Manual exposure - M

Manual exposure mode allows individual selection of shutter speeds and apertures. This mode overrides the exposure system giving the photographer total control over the final exposure. The shutter speeds can be changed in half stop increments between 1/1000 and 4 seconds.



As changes are made to the exposure, the effect will be visible on the monitor. The shutter-speed and aperture display will turn red on the monitor if the image is extremely under or overexposed. If the monitor is black, increase the exposure until the image is visible; decrease the exposure if the monitor is white. If the LCD monitor is turned off, the exposure is fixed at the last setting and cannot be changed. When the shutter-release button is pressed partway down, the brightness of the live image may change while the camera is focusing.

In manual exposure mode, the auto camera-sensitivity setting will fix the ISO value at 100. The camera sensitivity can be changed in the basic section of the multi-function recording menu (p. 54). The flash mode is set to flash cancel. Fill-flash can be selected (p. 30), but the live image will not reflect the ambient or flash exposure. Bulb exposures can be made, see page 58.

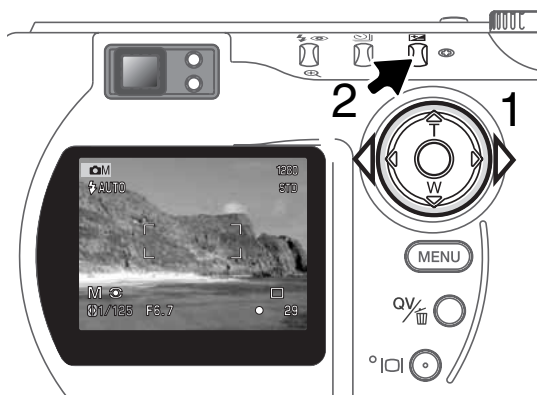

To change the shutter speed use the left/right keys of the controller (1) to set the desired shutter speed.

To change the aperture press the exposure-compensation button (2); the aperture value will turn blue. Use the left/right keys of the controller (1) to set the desired aperture.

The exposure-compensation button switches between the shutter speed and aperture display. The value that can be set will be blue with a double arrow icon to the left.

# BULB EXPOSURES

Bulb photographs can be taken in the manual-exposure mode (M) (p. 57). Exposures up to fifteen seconds can be made by pressing and holding the shutter-release button. The use of a tripod is recommended. The camera's exposure system cannot be used to calculate bulb exposures; a separate light meter is recommended.

Set the exposure mode to manual in the basic section of the multi-function recording mode menu (p. 54). Set the drive mode to single-frame advance (p. 32).

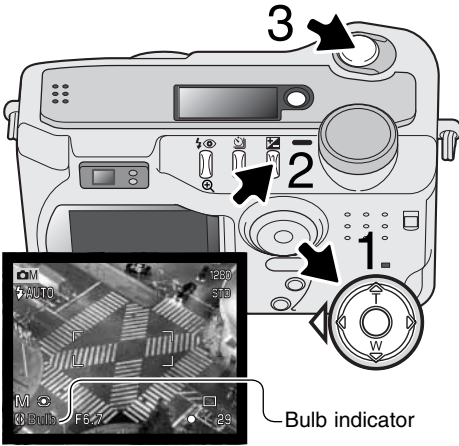

Use the controller (1) to decrease the shutter-speed value below four seconds until "bulb" is displayed.

To set the aperture value, press the exposure-compensation button (2); the aperture display should turn blue. Use the controller (1) to set the aperture.

To take the picture, press and hold the shutter-release button (3) for the duration of the exposure. Releasing the shutter button will end the exposure. The monitor will be blank during the exposure.

## Camera Notes

When making bulb exposures, noise can be more pronounced because of the unusually long exposure times, especially at 400 ISO. When making long bulb exposures, a camera sensitivity setting of 64 or 100 will produce excellent results. At higher ISO settings, using shorter exposure times (8 seconds or less) will reduce the effect of noise.

# FOCUS MODES

This camera has autofocus and manual focus control. The focus mode is set in the basic section of the multi-function recording mode menu (p. 54).

Autofocus will produce excellent results in almost every situation, however, under certain conditions, the autofocus system will not work accurately; see special focusing situations on page 27. In these situations the camera can be manually focused.

After setting the camera to the manual focus mode (MF), "ZOOM" and "FOCUS" will appear at the top of the LCD monitor. Press the center of the controller to switch between the two functions; the function highlighted in blue is active. With "FOCUS" highlighted, use the up/down keys of the controller to focus; the approximate focus distance is displayed at the bottom of the monitor next to the frame counter. All distances are measured from the CCD.

When the focus is set to the minimum focusing distance, as the lens is zoomed, the distance will change to match the minimum focusing distance at each focal length. Manual focus is not available when the monitor is turned off; the controller function is automatically switched to the zoom.

Press the controller to switch between focus and zoom (1). The active function is highlighted in blue (2).

Use the up/down keys of the controller to zoom or focus.

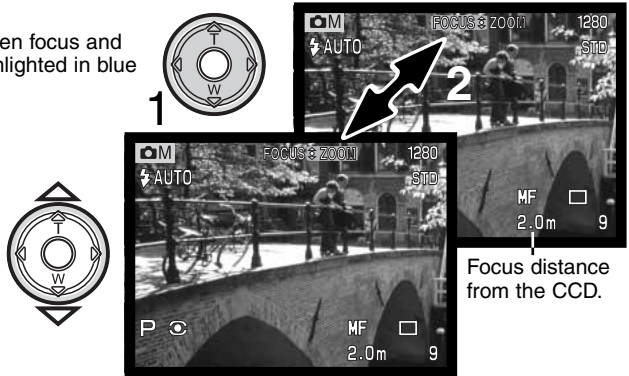

## WHITE BALANCE

White balance is the camera's ability to make different types of lighting appear neutral. The effect is similar to selecting daylight or tungsten film, or using color compensating filters in conventional photography.

An indicator is displayed on the monitor if a setting other than auto white-balance is chosen. White balance is set in the basic section of the multi-function recording mode menu (p. 54).

### *Automatic White Balance*

The automatic white balance compensates for the color temperature of a scene. In most cases, the auto setting will balance the ambient light and create beautiful images, even under mixed-lighting conditions. When the built-in flash is used, the white balance is set for the color temperature of the flash.

### *Preset White Balance*

Preset white-balance settings must be set before the image is taken. Once set, the effect is immediately visible on the LCD monitor.

The built-in flash can be used with preset white-balance settings, but will create a pinkish or blueish cast with the fluorescent and tungsten settings. The flash is daylight balanced and will produce acceptable results with the daylight and cloudy settings.



**Cloudy** - for overcast outdoor scenes.



**Daylight** - for outdoor and sunlit subjects.



**Tungsten** - for incandescent lighting: household filament light bulbs.



**Fluorescent** - for fluorescent lighting: office ceiling lights.

## Custom White Balance

Custom-white-balance function allows a photographer to calibrate the camera to a specific lighting condition. The setting can be used repeatedly until reset. Custom white balance is especially useful with mixed-lighting conditions or when critical control over color is needed. The object used to make a calibration should be white. A blank piece of white paper is an ideal surface and can easily be carried in a camera bag. To calibrate the white balance for ambient light exposures, set the flash mode to flash-cancel (p. 30).

To calibrate the camera, select the custom setting in the white balance option in the basic section of the multi-function recording mode menu; a window will open asking you to choose “set” or “recall.” Use the controller to highlight “set” and then press the center of the controller to enter the command; the custom white-balance calibration screen will appear.

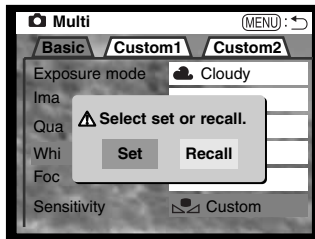

Fill the image area with a white object; the object does not need to be in focus. Press the shutter-release button to make the calibration. The custom setting will remain in effect until another calibration is made or the white-balance setting is changed.

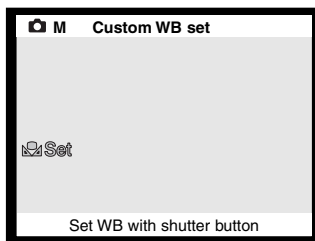

If the custom white-balance setting needs to be used again, select the custom setting on the basic section of the menu; a window will appear. Highlight “recall” and press the controller to enter the command; the last custom white-balance setting will be applied to the camera.



## CAMERA SENSITIVITY - ISO

Five camera sensitivity settings can be selected: Auto, 64, 100, 200, and 400; the numerical values are based on an ISO equivalent. ISO is the standard used to indicate film sensitivity: the higher the number, the more sensitive the film. Camera sensitivity is set in the basic section of the multi-function recording mode menu (p. 54).

The auto setting automatically adjusts the camera sensitivity to the light conditions between ISO 64 and 320. When the flash is activated and camera sensitivity is set to auto, the ISO value is set between ISO 64 and 200. When any other setting than auto is used, "ISO" will appear on the data panel, and "ISO" and the set value will be displayed on the monitor.

Photographers can select a specific sensitivity setting. As the ISO value doubles, the camera sensitivity doubles. Like grain in silver-halide film that increases with speed, noise increases with sensitivity in digital imaging; an ISO setting of 64 will have the least noise and 400 will have the most noise. An ISO setting of 400 may allow the camera to be hand-held in low-light conditions without the need of a flash.

## FLASH RANGE AND CAMERA SENSITIVITY

The flash range is measured from the CCD. Because of the optical system, the flash range is not the same at the lens' wide-angle position as it is at the telephoto position.

ISO setting	Flash range (wide angle)	Flash range (telephoto)
AUTO	0.5m ~ 3.5m (1.6 ft. ~ 11.5 ft.)	0.9m ~ 3.0m (3.0 ft. ~ 9.8 ft.)
64	0.5m ~ 2.0m (1.6 ft. ~ 6.6 ft.)	0.9m ~ 1.7m (3.0 ft. ~ 5.6 ft.)
100	0.5m ~ 2.5m (1.6 ft. ~ 8.2 ft.)	0.9m ~ 2.1m (3.0 ft. ~ 6.9 ft.)
200	0.5m ~ 3.5m (1.6 ft. ~ 11.5 ft.)	0.9m ~ 3.0m (3.0 ft. ~ 9.8 ft.)
400	0.5m ~ 5.0m (1.6 ft. ~ 16.4 ft.)	0.9m ~ 4.2m (3.0 ft. ~ 13.8 ft.)

At the wide-angle lens position, when using the flash with subjects closer than 1m (3ft), vignetting can occur. A slight shadow or shading may be apparent at the bottom of a horizontal image.

## FULL-TIME AF

With full-time AF active, the autofocus systems continually focuses to keep the monitor image sharp. This also reduces the autofocusing time when taking pictures. Full-time AF can be activated in the custom 1 section of the multi-function recording mode menu (p. 54).

When the monitor is turned off or when the camera is set to manual focus, full-time AF is disabled. Turning the full-time AF function off can help conserve battery power.

## METERING MODES

The icons indicating the metering modes are displayed on the monitor. The metering mode is set in the custom 1 section of the multi-function recording mode menu (p. 54).



Multi-segment metering uses 270 segments to measure luminance and color. This data is combined with distance information to calculate the camera exposure. This advanced metering system will give accurate worry-free exposures in almost all situations.



Spot metering uses a small area within the image to calculate the exposure. When this mode is selected, the LCD monitor will automatically activate if off and a small circle will appear in the middle of the live image indicating the measuring area. The spot allows precise exposure measurements of a particular object without being influenced by extremely bright or dark areas within the scene. If the LCD monitor is turned off, the spot-metering mode will remain active.

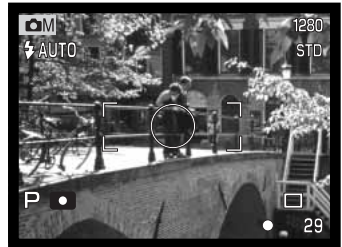

## EXPOSURE BRACKETING INCREMENT

In multi-function recording mode, three bracketing steps can be selected: 0.3 Ev, 0.5 Ev, 1.0 Ev. The larger the number, the greater the difference in exposure between the images in the bracketed series. For information on the bracketing drive mode, see page 36. The bracketing increment can be changed in the custom 1 section of the multi-function recording mode menu (p. 54).

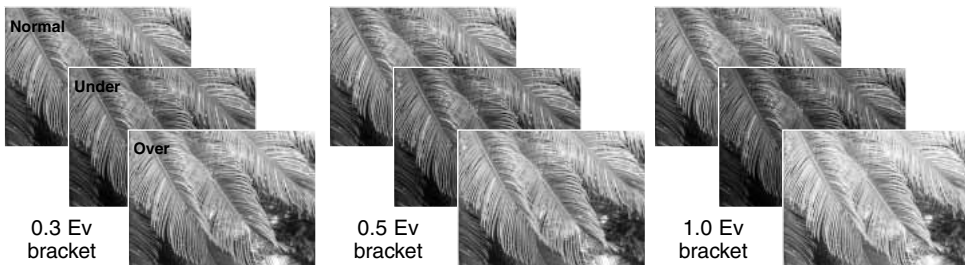

## COLOR MODE

The color mode controls the appearance of a still image. This must be set before the image is recorded. The color mode is set in the custom 2 section of the multi-function recording mode menu (p. 54). The live image on the monitors will reflect the selected mode. The color mode has no effect on image file size.

Natural Color reproduces the colors in the scene faithfully. This mode uses no monitor indicator when active. Vivid Color increases the saturation of colors. Black & White produces monochrome images. The sepia mode creates warm tone monochrome images. Solarization produces a partial reversal of tones and colors in the highlights.

<b>VIVID</b>	Vivid Color
	Natural Color
<b>BW</b>	Black & White
<b>SOL</b>	Solarization
<b>SEPIA</b>	Sepia

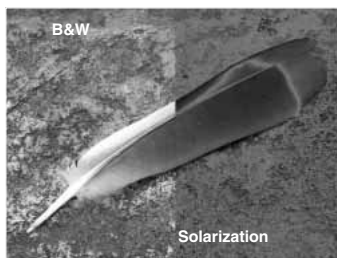





## IMAGE CONTROL - SHARPNESS, CONTRAST, & FILTER

Changes in color, sharpness, and contrast can be made using the custom 2 section of the multi-function recording mode menu (p. 54). The sharpness, contrast and filter imaging controls give photographers the ability to maximize the image information at the scene.

Any changes made with these functions are applied to the live image on the monitor. Changes made to sharpness and contrast may be difficult to see on the monitor. However, when viewed on a computer, the changes will be evident. The levels must be set before the image is recorded. If any setting other than normal or off is selected, an indicator will be displayed showing an increase (+) or decrease (-) in the quality selected. Turning the camera off will not reset these functions.

	Sharpness	To accent or soften details in an image in three levels: hard (+), normal, and soft (-).
	Contrast	To increase or decrease the contrast of the scene in three levels: high (+), normal, and low (-).
	Filter	To adjust the overall color of a Natural Color or Vivid Color image: warm (+) and cool (-).

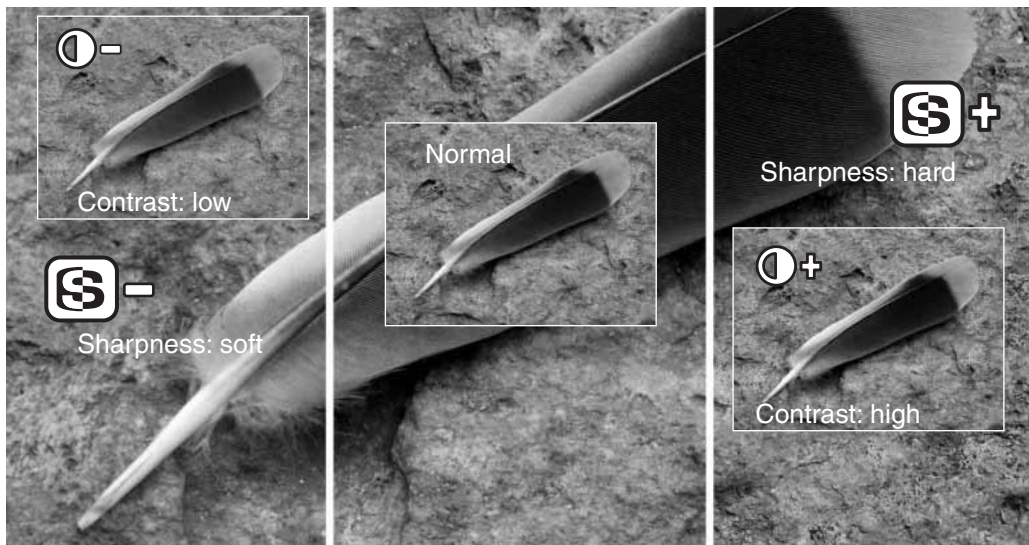

# A SHORT GUIDE TO PHOTOGRAPHY

Photography can be a rewarding pursuit. It is a broad and disciplined field that can take years to master. But the pleasure in making photographs and the joy of capturing a magical moment cannot be compared. This guide is an introduction to some basic photographic principles.

The lens aperture controls not only exposure, but also depth of field; the area between the closest and the furthest object in focus. The larger the aperture value, the greater the depth of field and the longer the shutter speed needed to make the exposure. The smaller the aperture value, the shallower the depth of field and the faster the shutter speed needed to make the exposure. Usually landscape photographs use a large depth of field (large aperture value) to keep the foreground and background in focus, and portraits use a shallow depth of field (small aperture value) to separate the subject from the background.



Depth of field also changes with focal length. The wide-angle position of the lens has a large depth of field; the telephoto position has a shallow depth of field.

The shutter controls not only exposure, but also the ability to stop motion. Fast shutter speeds are used in sport photography to stop action. Slow shutter speeds can be used to show the flow of motion such as water cascading over a waterfall. The use of a tripod is recommended with slow shutter speeds.



The change in aperture and shutter speed is not apparent in the live image. Unlike film cameras, test photographs can be taken and immediately viewed. For critical work, take a test photograph at the set aperture or shutter speed and view the result in Quick View. The image can be deleted if not acceptable and another test image can be taken at a different setting.

# MOVIE RECORDING

This camera can record up to sixty seconds of digital video with sound. The motion JPEG image is 320 X 240 pixels (QVGA). The effective image area is 284 X 211 pixels; two thin lines will appear to the left and right of the image when played back. Under certain conditions less than sixty seconds of digital video may be recorded.

Total recording time with an 16MB CompactFlash card is approximately 51 seconds. The digital video recording rate is approximately 296KB per second. Actual CompactFlash card capacity depends on the subject and the number of still images captured.

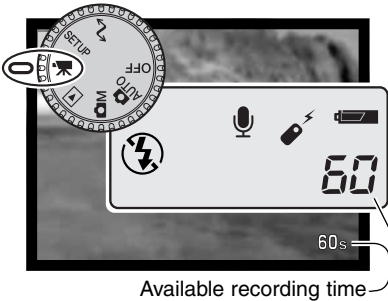

Available recording time

Set the main dial to movie recording. Before recording, the data-panel and monitor frame counters show the maximum time in seconds can be recorded with the next movie clip. A maximum of 60 seconds is displayed until the amount of remaining time falls below one minute, then the remaining number of seconds that can be recorded is displayed.

Frame the picture as described in the basic recording operation section (p. 25). Press the shutter-release button partway down to lock the focus. Press the shutter-release button all the way down and release to start recording. An indicator will appear in the lower right corner of the monitor during recording.



The zoom and focus are fixed during recording. The camera will continue to record until the recording time is used or the shutter-release button is pressed again. When recording, the data panel and monitor frame counters will count down the remaining time.

# NOTES ON MOVIE RECORDING

In movie recording, some functions can be used, some are fixed, and some are disabled. This mode has no menu controls.

Exposure mode	Program (fixed)
Camera sensitivity (ISO)	Auto (fixed)
Focus area	Wide focus area (fixed)
Focus control	Autofocus (fixed)
White balance	Auto (fixed)
Macro mode	Available (p. 28)
Exposure compensation	Available (p. 50)
Display button	All displays available except monitor off (p. 37)
Flash	Disabled
Digital zoom	Disabled

## RECORDING MOVIES WITH THE IR REMOTE CONTROL RC-3

The RC-3 remote control (sold separately) can be used to record movie clips up to 5m (16ft) away. Simply point the remote control toward the camera and use the release or delay button to start and stop the recording.

When using the release button, the self-time lamp (1) will blink once before the camera starts to record; when using the delay button, the self-timer lamp will blink for two seconds before recording. The lamp will glow to indicate the camera is recording. Both buttons will stop the camera instantly when pressed. The remote control may not operate with backlit subjects or under fluorescent light.

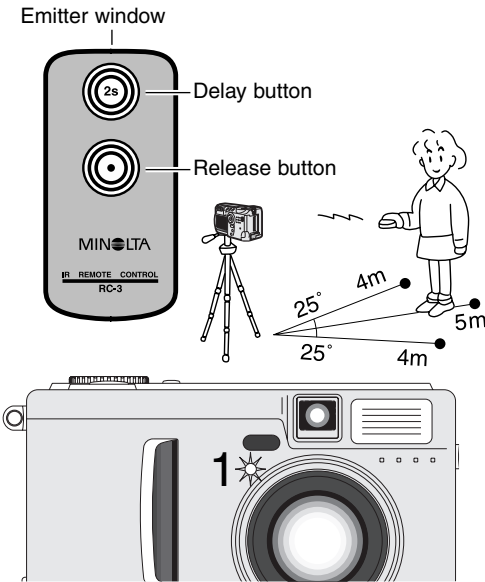

# PLAYBACK MODE - ADVANCED OPERATION

The basic functions in this mode are described in the basic playback section on pages 38 through 41. This section covers how to play back movie clips and voice memos as well as the advanced functions on the playback menu.

## PLAYING BACK VOICE MEMOS



Voice memos (p. 46) can be played back in Quick View and the playback mode. The voice memo indicator will be displayed at the bottom of the monitor if an audio track is attached to the displayed still image.



Press the center of the controller to start the audio playback.



Playback time is displayed on a bar at the top of the image. The display returns to Quick View or the playback mode when the audio track finishes.



Press the down key of the controller to cancel the playback.



Press the display button to view the image with or without the guidance bar.

Speaker

# VIEWING MOVIES

Movie clips can be played back in Quick View and the playback mode. A thumbnail of the first frame of the clip indicates a movie file.

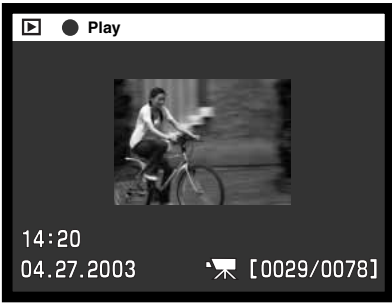

Use the left/right keys of the controller to display the movie clip to be viewed.



Press the center of the controller to play back the clip.



Playback time is displayed on a bar at the top of the image. The display returns to Quick View or the playback mode when the movie clip finishes.

Pressing the controller during playback pauses the movie clip; pressing the controller again resumes the playback. When the movie clip finishes, the first frame is displayed.



Press the display button to view the movie with or without the guidance bar.



To cancel the playback of a movie, press the down key of the controller.

## NAVIGATING THE PLAYBACK-MODE MENU

In playback mode, press the menu button (1) to activate the menu. The menu button also turns off the menu after making settings. The four-way keys of the controller (2) are used to move the cursor in the menu. Pressing the center of the controller will enter a setting.



Activate the playback-mode menu with the menu button. The **Basic** tab at the top of the menu will be highlighted. Use the left/right keys of the controller to highlight the appropriate menu tab; the menus will change as the tabs are highlighted.



When the desired menu section is displayed, use the up/down keys to scroll through the menu options. Highlight the option whose setting needs to be changed. When scrolling in one direction, the cursor will jump between the top and bottom of the menu.



With the menu option to be changed highlighted, press the right controller key; the settings will be displayed with the current setting highlighted. To return to the menu options, press the left key.



Use the up/down keys to highlight the new setting.



Press the controller to select the highlighted setting.

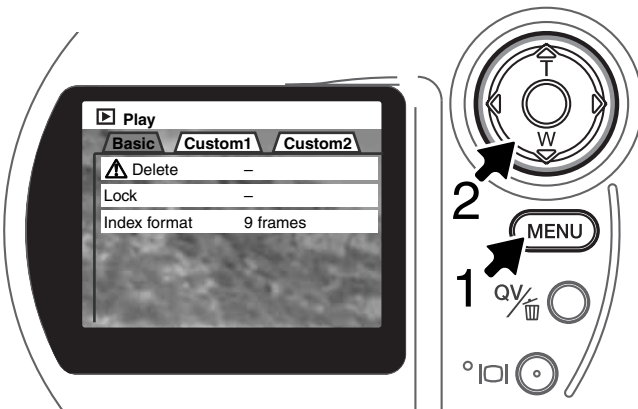

Once a setting has been selected, the cursor will return to the menu options and the new setting will be displayed. Changes can continue to be made. To return to the playback mode, press the menu button.



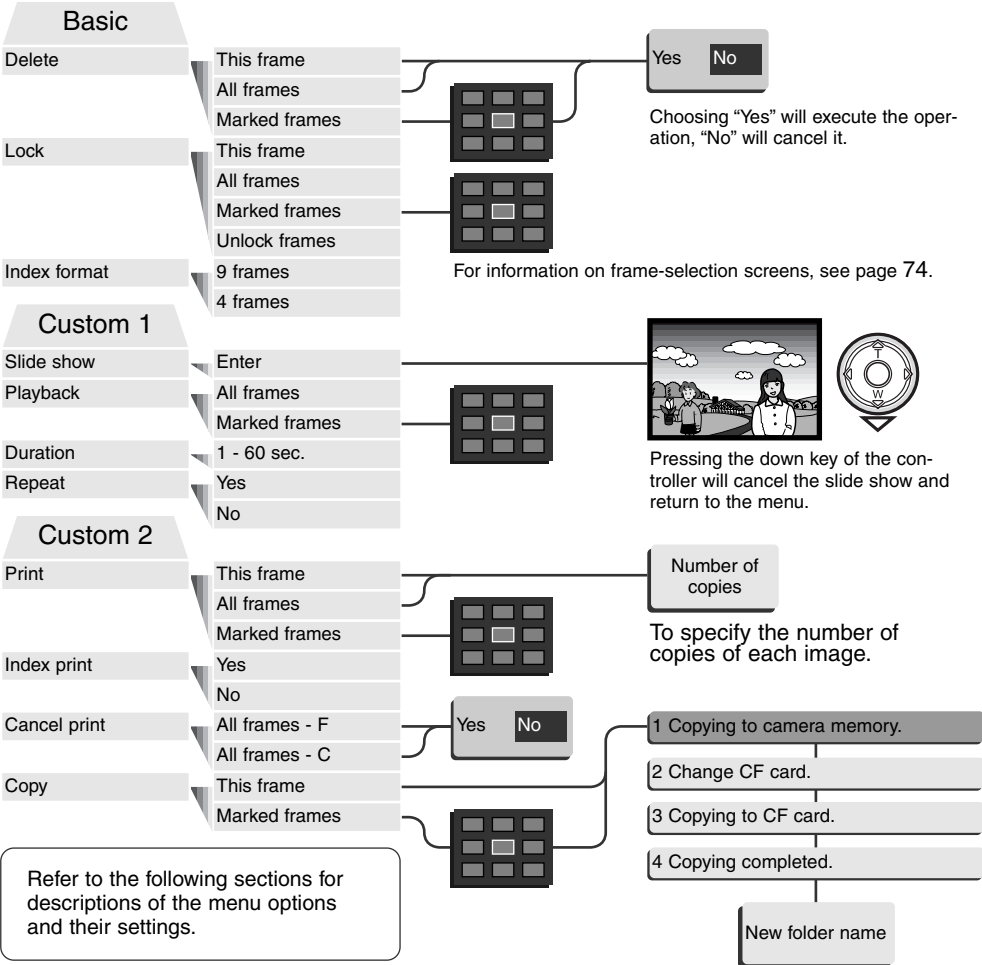

# FRAME-SELECTION SCREEN

When a marked-frames setting is chosen on a menu, the frame selection screen will appear. This screen allows multiple images to be chosen. An indicator in the bottom left corner shows if the image is a movie clip or has a voice memo. The index format of the screen can be changed in the basic section of the playback-mode menu (p. 72).



The left/right keys of the controller move the yellow border to select the image.

**Menu button**  
Cancels the screen and any operation made.

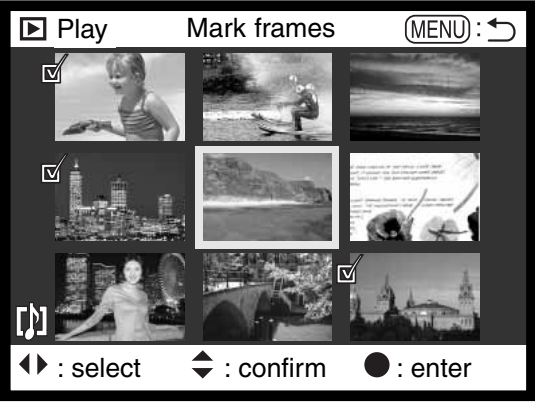

The up key of the controller selects the frame; when selected, an icon will appear next to the image. The down key will deselect the image removing the icon.



The garbage-can icon indicates the image is selected for deletion.



The key icon indicates the image is locked or selected to be locked.



The check icon indicates the image is selected for the slide show or to be copied to another CompactFlash card.



The printer icon indicates the image is selected for printing. The number next to the icon shows the number of copies requested.



Press the controller to complete the operation.

## VIEWING IMAGES ON A TELEVISION

It is possible to view camera images on your television. The camera has a video-out terminal to make the connection using the supplied AV cable. The camera is compatible with the NTSC and PAL standards. The video-output setting can be checked and set in the custom 2 section of the setup menu (p. 84).

1. Turn off the television and the camera.
2. Insert the mini-plug end of the AV cable into the camera's AV-out terminal.
3. Plug the other end of the AV cable into the video and audio input terminals on the television. The yellow plug is for the video output. The white plug is for the monaural audio output. The audio output will also be heard through the camera's speaker while connected to a television.
4. Turn the television on.
5. Change the television to the video channel.
6. Turn the camera's mode dial to the playback position. The camera's monitors will not activate when the camera is attached to a television. The playback-mode display will be visible on the television screen.
7. View images as described in the playback section.

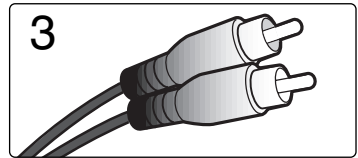
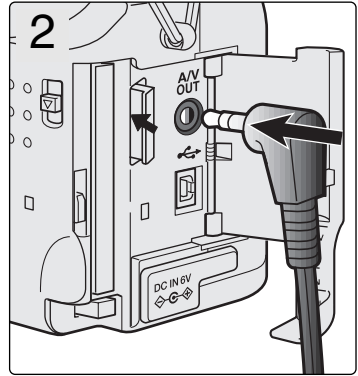

## DELETING FILES



Deleting permanently erases the file. Once deleted, a file cannot be recovered. Care should be taken when deleting images.

Single, multiple, or all files in a folder can be deleted with the playback-mode menu. Before an image file is deleted, a confirmation screen will appear; choosing “Yes” will execute the operation, “No” will cancel it. To delete files in other folders, the folder must first be selected in the custom 1 section of the setup menu (p. 84). The delete option has three settings:

**This frame** - The file displayed or highlighted in playback mode will be deleted.

**All frames** - All unlocked files in the selected folder will be deleted.

**Marked frames** - To delete multiple files. When this setting is chosen, the frame-selection screen will be displayed. Use the left/right keys of the controller to highlight the first file to be deleted. Pressing the up key will mark the thumbnail with the garbage-can icon. To deselect a file for deletion, highlight it with the yellow border and press the down key; the garbage-can icon will disappear. Continue until all the files to be deleted are marked. Press the controller to continue (the confirmation screen will appear), or press the menu button to cancel the operation and return to the playback menu. On the confirmation screen, highlighting and entering “Yes” will delete the marked files.

The delete function will only erase unlocked files. If a file is locked, it must be unlocked before it can be deleted.

## LOCKING FILES

Single, multiple, or all files in a folder can be locked. A locked file cannot be deleted by either the playback-mode menu functions or the QV/delete button. Important image files should be locked. To lock files in other folders, the folder must first be selected in the custom 1 section of the setup menu (p. 84). The lock option has four settings:

**This frame** - The file displayed or highlighted in playback mode will be locked.

**All frames** - All files in the folder will be locked.

**Marked frames** - To lock or unlock multiple files. When this setting is chosen, the frame-selection screen will be displayed. Use the left/right keys of the controller to highlight the file to be locked. Pressing the up key will mark the thumbnail with the key icon. To unlock a file, highlight it with the yellow border and press the down key; the key icon will disappear. Continue until all the files to be locked are marked. Press the controller to lock the marked frames, or press the menu button to cancel the operation and return to the playback menu.

**Unlock frames** - All files in the folder will be unlocked.

Locking a file will protect it from a delete function. However, the formatting function (p. 86) will erase all files on a CompactFlash card whether locked or not.

## CHANGING THE INDEX PLAYBACK FORMAT

The index format option allows the index playback to be displayed with four or nine images. This affects all index displays.



# SLIDE SHOW

The custom 1 section of the playback-mode menu controls the slide-show function. This function automatically displays all still images in a folder in order.



Frame count-down / total number of images in the presentation.



Press the controller to pause and restart the presentation.



To cancel the presentation, press the down key of the controller.

Menu options	Settings	
Slide show	Enter	To start the slide-show presentation. Pressing the center of the controller will pause the presentation. During the slide show, press the down key of the controller to stop the presentation and return to the playback-mode menu.
Playback	All frames	To select all the images in the folder to be displayed in the slide-show presentation.
	Marked Frames	To select specific images in the folder to be displayed in the slide-show presentation. When this setting is chosen, the frame-selection screen will be displayed. Use the left/right keys of the controller to highlight the image to be included in the presentation. Pressing the up key will mark the image with a check icon. To deselect a marked image, highlight it with the yellow border and press the down key; the check icon will disappear. Continue until all the images have been edited. Press the controller to set the marked frames, or press the menu button to cancel the operation and return to the playback menu.
Duration	1 - 60s.	To select the period each image will be displayed during the slide show.
Repeat	Yes / No	Selecting “Yes” will cause the slide show to repeat until it is canceled using the down key of the controller. “No” will end the slide show presentation and return to the playback-mode menu when all the images have been displayed once.

## ABOUT DPOF

This camera is supported by DPOF™ version 1.1. The DPOF (Digital Print Order Format) allows direct printing of still images from digital cameras. After the DPOF file is created, the CompactFlash card is simply taken to a photofinishing service or inserted into the CompactFlash-card slot of DPOF compatible printers. When a DPOF file is created, a misc. folder is automatically made on the CompactFlash card to store it (p. 98).

## CREATING A DPOF PRINT ORDER

The print menu option is used to set an order for standard prints from images in a specific folder. Single, multiple, or all images can be printed. If a CompactFlash card has multiple folders, a printing file must be created for each folder. Folders are selected in the custom 1 section of the setup menu (p. 84).

**This-frame** - To create a DPOF file for the image displayed or highlighted in playback mode.

**All-frames** - To create a DPOF file for all images in the folder specified in the custom 1 section of the setup menu (p. 84).

**Marked frames** - To chose a group of images to be printed or when the number of copies for each image varies. When selected, the frame selection screen will appear. Use the left/right keys of the controller to highlight an image to be printed. Pressing the up key will mark the image with the printer icon. The number next to the icon indicates the number of copies of that image will be printed. Pressing the up key will increase the number of copies, pressing the down key will decrease the number. A maximum of nine copies can be ordered. To deselect an image for printing, press the down key until the the number of copies reaches zero and the printer icon disappears. Continue until all the images to be printed are marked. Press the controller to create the DPOF file, or press the menu button to cancel the operation and return to the playback menu.



When the this-frame or all-frames setting is chosen, a screen will appear requesting the number of copies of each image; a maximum of nine copies can be ordered. Use the up/down keys of the controller to set the number of copies desired. If the all-frames setting was used to create a print order, any additional images saved afterwards in the folder will not be included in the order.

DPOF files created with another camera will be canceled.

## ORDERING AN INDEX PRINT

To create an index print of all the images in the folder, select “Yes.” To cancel an index print, simply change the setting to “No.” If an index-print order is created, any additional images saved afterwards in the folder will not be included in the index print. If a CompactFlash card has multiple folders, an index print must be selected for each folder. Folders are selected in the custom 1 section of the setup menu (p. 84).

The number of images printed per sheet differs between printers. The information printed with the thumbnails can vary.



## CANCELING A DPOF PRINT ORDER

The cancel-print option deletes the DPOF files. When the setting is selected, a confirmation screen will appear; choosing and entering “Yes” will execute the operation and cancel the print order.

All frames F - To cancel the printing file in the folder. Folders are selected in the custom 1 section of the setup menu (p. 84).

All frames C - To cancel all printing files on the CompactFlash card.

## COPYING IMAGES

Image files can be copied from one CompactFlash card to another. Up to 23MB of data can be transferred. Every time the copy function is used, a new folder is automatically created for the images (p. 98). Images with voice memos are copied with their audio files. Copies of locked images are unlocked (p. 77). DPOF information is not copied.

**This frame** - To copy the image displayed or highlighted in playback mode.

**Marked frames** - To copy single or multiple images. When selected, the frame-selection screen will appear; highlight the image to be copied with the yellow border and then press the up key of the controller to mark it with the check icon. To deselect an image to be copied, highlight the selected image and press the down key; the check icon will disappear. Continue until all the images to be copied are marked. Press the controller to continue, or press the menu button to cancel the operation and return to the playback menu.

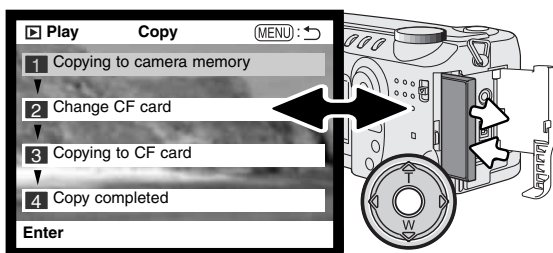

When the image(s) to be copied are selected, a screen with four messages is displayed; the messages are highlighted during the copying procedure. When the change-CF-card message is highlighted, remove the camera's CompactFlash card and insert the card to which the image should be copied.

Press the center of the controller to continue or the menu button to cancel the copy operation.

After the copy-completed message is highlighted, a new screen will appear to indicate the name of the new folder containing the copied images; press the controller to return to the menu.



If too many images have been selected, a warning will appear and the copy routine will be canceled. Divide the number of images into two or three batches. The copy-unsuccessful message will appear when one or all of the images could not be copied. Check the second CompactFlash card to see which files were copied and then repeat the procedure for the images that were not transferred.

## Minolta History

On February 20th, 1962, John Glenn became the first American to orbit the Earth. On board his Friendship 7 spacecraft was a Minolta Hi-matic camera to record that historic event. The 4 hour, 55 minute, and 23 second flight orbited the Earth three times at an average speed of 28,000 kph (17,500 mph).

Mr. Glenn visited our Sakai camera factory in Japan on May 24th, 1963 to plant a palm tree to celebrate the occasion. The palm tree is still in the courtyard of the factory and stands over eight meters tall (26ft).

The camera? It was not lost. It is on display at the Smithsonian Institution's National Air and Space Museum in Washington D.C. This and other objects from John Glenn's Friendship 7 Mercury flight can be found in galley 210, "Apollo to the Moon."



# SETUP MODE

## NAVIGATING THE SETUP MENU

To access the menu, simply turn the mode dial to the setup position. The four-way keys of the controller (1) are used to move the cursor in the menu. Pressing the controller will enter a setting.



When the menu activates, the **basic** tab at the top of the menu will be highlighted. Use the left/right keys of the controller to highlight the appropriate menu tab; the menus will change as the tabs are highlighted.



When the desired menu section is displayed, use the up/down keys to scroll through the menu options. Highlight the option whose setting needs to be changed. When scrolling in one direction, the cursor will jump between the top and bottom of the menu.



With the menu option to be changed highlighted, press the right controller key; the settings will be displayed with the current setting highlighted. To return to the menu options, press the left key.



Use the up/down keys to highlight the new setting.



Press the controller to select the highlighted setting.

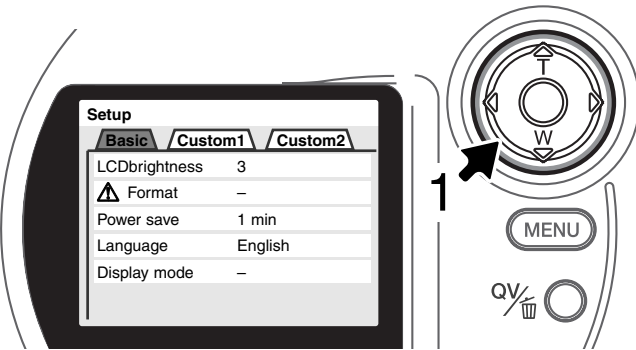

Once a setting has been selected, the cursor will return to the menu options and the new setting will be displayed. Setting can continue to be made.

Basic	
LCD brightness	1 (Low) ~ 5 (High)
Format	Enter
Power save	1, 3, 5, 10 min.
Language	Japanese English Deutsch Français Español
Display mode	Standard display Focus frame Histogram Grid Scale Image only

Custom 1	
File # memory	On / Off
Folder name	Standard form Date form
Select folder	(Folder name)
Audio signals	Off 1 2
Shutter FX	Off 1 2
Volume	1 (Low) - 3 (High)

Refer to the following sections for descriptions of the menu options and their settings.

Custom 2	
Reset default	Enter
Date/Time set	Enter
Date format	YYYY/MM/DD MM/DD/YYYY DD/MM/YYYY
Video output	NTSC PAL
<input type="button" value="Yes"/> <input checked="" type="button" value="No"/>	

Choosing "Yes" on the confirmation screens will execute the operation, "No" will cancel it.

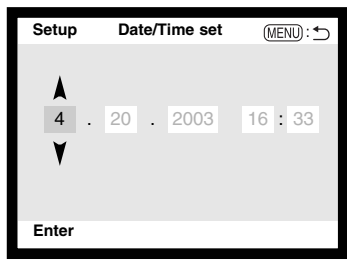

On the date/time setting screen, use the left/right keys of the controller to select the year, month, day, hour, or minute. The up/down keys are used to change the value. Press the central button of the controller to set the calendar and clock.

## LCD MONITOR BRIGHTNESS

The brightness of the LCD monitor can be set in five levels from 1 (low) to 5 (high). When this option is selected, the live image is displayed behind the menu. As each setting is highlighted, the monitor will adjust accordingly; the controller must be pressed to set the highlighted level.

## FORMATTING COMPACTFLASH CARDS



When a CompactFlash card is formatted, all data is erased.

The formatting function is used to erase all data on a CompactFlash card. Before formatting a CompactFlash card, copy the data to a computer or storage device. Locking images will not protect them from being deleted when the card is formatted. Always format the CompactFlash card using the camera; never use a computer to format a card.

When the format option is selected and entered, a confirmation screen will appear. Choosing “Yes” will format the card, choosing “No” will cancel the formatting operation. A screen will appear to indicate the card has been formatted; press the controller to return to the setup menu.

A CompactFlash card used in another camera may have to be formatted before being used. If the unable-to-use-card message appears, the card is not compatible with the camera and cannot be formatted.

## AUTO POWER SAVE

The camera will turn off the data panel to conserve battery power if no operation is made within a certain period. The length of this period can be changed to 1, 3, 5, or 10 minutes. The auto-power-save option will not affect the display period of LCD monitor; it will shut down after 30 seconds. To restore the displays when they shut down, simply press the shutter-release button.

When the camera is connected to the computer, the auto-power-save period is set to ten minutes. This period cannot be changed.

# LANGUAGE

The language used in the menus can be changed. The language is selected in the basic section of the setup menu (p. 84).

# DISPLAY MODE



Standard display



Focus frame only

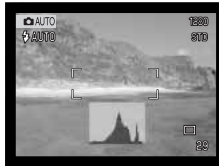

Real-time histogram

The recording mode displays activated by the display button (p. 37) can be selected in the basic section of the setup menu. The display cycle is the same as the order shown on the menu.

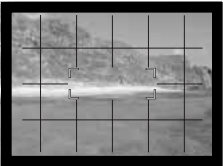

Grid

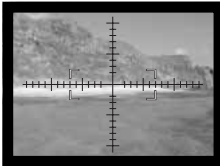

Scale



Live image only

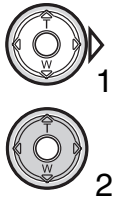
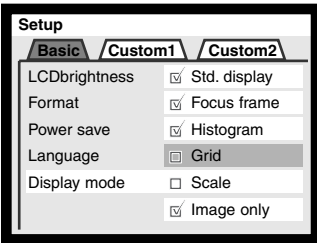

Display-mode settings with a check mark are included in the display cycle. To change displays used, highlight the setting using the controller, and then press the right key (1) to check or uncheck the box. Press the controller to set the selected displays (2).

## FILE NUMBER (#) MEMORY

When file number memory is selected, if a new folder is created, the first file stored in the folder will have a number one greater than the last file saved. If the file number memory is disabled, the image file name will have a number one greater than the last image saved in the folder.

If file number memory is active and the CompactFlash card is changed, the first file saved to the new card will have a number one greater than the last file saved on the previous card if the new card does not contain an image with a greater file number. If it does, the file number of the new image will be one greater than the greatest on the card.

## FOLDER NAME

All recorded images are stored in folders on the memory card. Folder names come in two formats, standard and date.

Standard folders have an eight character name. The initial folder is named 100MLT24. The first three digits are the folder's serial number, which will increase by one each time a new folder is created. The next three letters refer to Minolta, and the last two numbers indicate the camera used; 24 indicates a DiIMAGE S414.



100MLT24  
(Standard)

A date folder name also starts with the three digit serial number and is followed by one register for the year, two register for the month, and two registers for the day: 101YMMDD. The folder 10130412 was created in 2003 on April 12th.



10130412  
(Date)

With the date folder format selected, when an image is recorded a new folder with the day's date will be created. All images recorded that day will be placed in that folder. Images recorded on a different day will be placed in a new folder with the corresponding date. If the file number memory function is off, when a new folder is created, the serial number in the image-file name is reset to 0001. If file number memory function is on, the serial number in the image-file will be one greater than the last image saved. For more information on folder organization and file names, see page 98.



## SELECT FOLDER

This option allows the selection of existing folders. All images recorded will be placed in the selected folder if the folder-name option is set to standard form. In quick view or playback mode, only the images in the selected folder can be viewed or edited.

Except for the all-frames-C setting in the custom 2 section of the playback-mode menu, changes made with menus only affect the images in the selected folder. To make changes to all images in multiple folders, each folder must be selected and the menu operation repeated for each folder. Formatting a CompactFlash card erases all folders regardless if they are selected or not.

## AUDIO SIGNALS

Every time a button is pressed, an audio signal will give a positive confirmation of the operation. The audio signals can be turned off in the custom 1 section of the setup menu (p. 84). The tone of the signal can also be changed; signal 1 is mechanical and signal 2 is electrical.

## SHUTTER FX

When the shutter is released, a shutter sound effect will give a positive confirmation of the operation. The sound effect can be turned off in the custom 1 section of the setup menu (p. 84). Two shutter effects are available; signal 1 is mechanical and signal 2 is electrical. The mechanical shutter sound was taken from the legendary Minolta CLE, a compact rangefinder that represents the pinnacle of the development of the Leitz-Minolta CL.



## VOLUME

The speaker volume can be increased or decreased. This affects the audio signals and shutter FX only and will not change the levels of the voice memo or movie audio track.

## RESETTING THE CAMERA

This function affects all modes. When selected, a confirmation screen will appear; choosing “Yes” resets the following functions and settings, “No” cancels the operation.

	Default Setting	Page
Exposure mode	Program	56
Focus mode	Autofocus	59
Focus area	Wide focus area	52
Digital zoom	Off	48
Drive mode	Single-frame advance	32
Flash mode	Auto flash	30
Image quality	Standard	44
Image size	2272 X 1704	44
Voice memo	Off	46
Date imprinting	Off	47
Instant playback	Off	49
Metering mode	Multi-segment	63
Exposure compensation	0.0	50
Camera sensitivity (ISO)	Auto	62
White balance	Auto white balance	60
Full-time AF	Off	63
Exposure bracket	0.5 Ev	64
Color mode	Natural Color	64
Sharpness	Normal	65
Contrast	Normal	65
Filter	Off	65
Index playback format	9 frames	77
Duration (Slide Show)	5 seconds	78
Repeat (Slide Show)	No	78

LCD monitor brightness	3	86
Auto-power-save period	1 minute	86
Display mode	Standard, focus frames only, real-time histogram, live image only	87
File number memory	Off	88
Folder name	Standard	88
Audio signals	1	89
Shutter FX	1	89
Volume	2	89

## DATE AND TIME SETTING

It is important to accurately set the clock. When a still image or a movie clip is recorded, the date and time of the recording are saved with the image and are displayed during playback or can be read with the DiMAGE Viewer software included on the CD-ROM. The camera's clock is also used with date imprinting (p. 47). To set the clock and calendar, see page 20.

## DATE FORMAT

The date format that is displayed or imprinted can be changed: YYYY/MM/DD (year, month, day), MM/DD/YYYY (month, day, year), DD/MM/YYYY (day, month, year). Simply select the format and enter it by pressing the center of the controller; the new format will be displayed on the menu.

## VIDEO OUTPUT

Camera images can be displayed on a television (p. 75). The video output can be changed between NTSC and PAL. North America uses the NTSC standard and Europe uses the PAL standard. Check which standard is used in your region to play back images on your television set.

# DATA-TRANSFER MODE

Read this section carefully before connecting the camera to a computer. Details on using and installing the DiIMAGE Viewer software are found in the supplied software manual. The DiIMAGE manuals do not cover the basic operation of computers or their operating systems; please refer to the manual supplied with your computer.

## SYSTEM REQUIREMENTS

For the camera to be connected directly to the computer and used as a mass-storage device, the computer must be equipped with a USB port as a standard interface. Both the computer and the operating system must be guaranteed by their manufacturers to support USB interface. The following operating systems are compatible with the camera:

IBM PC / AT Compatible	Macintosh
Windows 98, 98SE, Me, 2000 Professional, and XP.	Mac OS 9.0 ~ 9.2.2 and Mac OS X 10.1.3 - 10.1.5, 10.2.1, and 10.2.2.

Check the Minolta web site for the latest compatibility information:

North America: <http://www.minoltausa.com>

Europe: <http://www.minoltasupport.com>

Users with Windows 98 or 98 second edition will need to install the driver software on the included DiIMAGE Viewer CD-ROM (p. 95). No special driver software is required for other Windows or Macintosh operating systems.

Customers who have bought a previous DiIMAGE digital camera and have installed the Windows 98 driver software must repeat the installation procedure. The updated version of the driver software included on the supplied DiIMAGE Viewer CD-ROM is required for the operation of the DiIMAGE S414 with a computer. The new software will have no affect on the performance of older DiIMAGE cameras.

# CONNECTING THE CAMERA TO A COMPUTER

A fresh set of batteries should be used when the camera is connected to a computer. The use of the AC adapter (sold separately) is recommended over the use of batteries. For users with Windows 98 or 98SE, read the section on how to install the necessary USB driver before connecting the camera to a computer (P. 95).

1 Start up the computer. The computer must be turned on before connecting the camera.

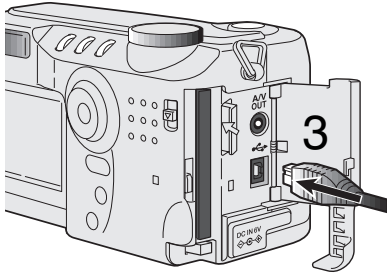

2 Insert the CompactFlash card into the camera. Confirm that the correct card is in the camera. To change the CompactFlash while the camera is connected to a computer, see page 102.

3 Open the card-slot door. Attach the smaller plug of the USB cable to the camera. Make sure the plug is firmly attached.

4 Attach the other end of the USB cable to the computer's USB port. Make sure the plug is firmly attached. The camera should be connected directly to the computer's USB port. Attaching the camera to a USB hub may prevent it from operating properly.

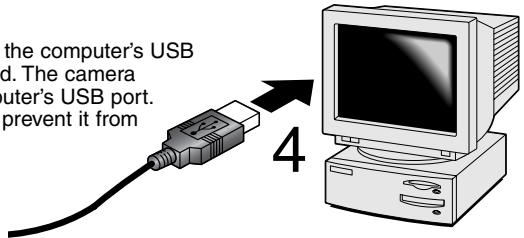

5 Set the mode dial to the data-transfer position to initiate the USB connection. A screen will appear to indicate the beginning of the connection process. When the signal has been received by the computer, the LCD monitor will turn off.

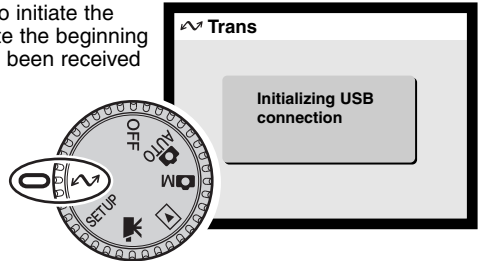



Windows XP

When the camera is properly connected to the computer, a drive icon, or volume, will appear. When using Windows XP or Mac OS X, a window will open requesting instructions on what to do with the image data; follow the directions in the window. If the computer does not recognize the camera, disconnect the camera and restart the computer. Repeat the connection procedure above.



Mac OS X

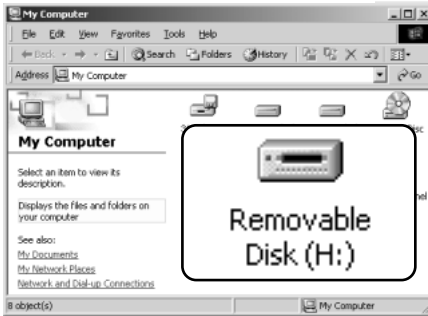

Windows

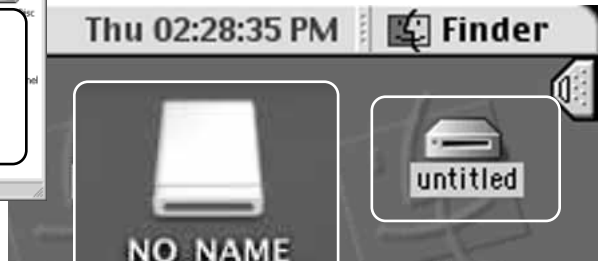

Mac OS X

Mac OS

The volume name varies between memory cards.

## CONNECTING TO WINDOWS 98 AND 98 SECOND EDITION

The driver needs only to be installed once. If the driver cannot be installed automatically, it can be installed manually with the operating system's add-new-hardware wizard; see the instructions on the following page. During installation, if the operating system requests the Windows 98 CD-ROM, insert it into the CD-ROM drive and follow the accompanying instructions on the screen. No special driver software is required for other Windows or Macintosh operating systems.

### Automatic Installation



Before connecting the camera to the computer, place the DiIMAGE Viewer CD-ROM in the CD-ROM drive. The DiIMAGE installer menu should automatically activate. To automatically install the Windows 98 USB driver, click on the starting-up-the-USB-device-driver-installer button. A window will appear to confirm that the driver should be installed; click "Yes" to continue.



When the driver has been successfully installed, a window will appear. Click "OK." Restart the computer and connect the camera (p. 93) to complete the operation.

## Manual Installation

To install the Windows 98 driver manually, follow the instructions in the connecting-the-camera-to-a-computer section on page 93.

When the camera is plugged into the computer, the operating system will detect the new device and the add-new-hardware-wizard window will open. Place the DiMAGE software CD-ROM in the CD-ROM drive. Click “Next.”



Choose the recommended search for a suitable driver. Click “Next.”



Choose to specify the location of the driver. The browse window can be used to indicate the driver location. The driver should be located in the CD-ROM drive at :Win98\USB. When the location is shown in the window, click “Next.”







The add new hardware wizard will confirm the location of the driver. Click “Next” to install the driver in the system.

One of three drivers may be located: MNLVNUM.inf, USBPDR.inf, or USBSTRG.inf. The letter designating the CD-ROM drive will vary between computers.

The last window will confirm the driver has been installed. Click “Finish” to close the add new hardware wizard. Restart the computer.

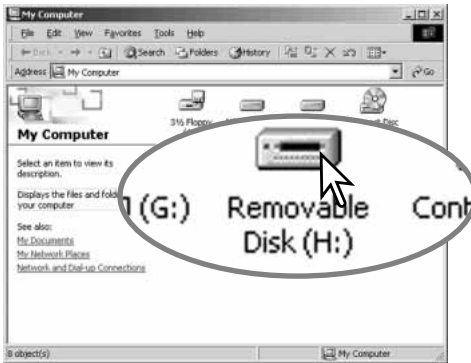

When the my-computer window is opened, a new removable-disk icon will be displayed. Double click on the icon to access the camera’s CompactFlash card; see page 98.

# COMPACTFLASH CARD FOLDER ORGANIZATION



Drive Icon

Once the camera is connected to the computer, image and audio files can be accessed by double clicking on icons. Image folders are located in the DCIM folder. To copying images and audio recordings, simply drag and drop the file icon into a location in the computer. Files and folders on the memory card can be deleted using the computer. Never format the memory card from the computer; always use the camera to format the card. Only files recorded by the camera should be stored on the memory card.



Dcim



Misc

The misc. folder contains DPOF print files (p. 80).



100MLT24



10130801



102MLTCP



PICT0001.TIF



PICT0002.JPG

Fine, standard, or economy image



PICT0002.WAV

PICT0002's voice-memo audio file



PICT0003.MOV



PICT0001.THM

TIFF image



PICT0003.THM

Movie clip

Image and audio file names begin with "PICT" followed by a four-digit file number and a tif, jpg, mov, or thm extension. Voice-memo audio files have a wav extension and the file name corresponds to its image file. The thumbnail images (thm) are produced with TIFF images and movie clips and are only used in camera and DiIMAGE Viewer operation.

Copy images (p. 82) are placed in a folder with a name ending in "CP." When a new folder is created, the first three digits in the folder name will be one greater than the largest folder number on the card. When the index number in the image file name exceeds 9,999, a new folder will be created with a number one greater than the greatest folder number on the memory card: e.g. from 100MLT24 to 101MLT24.

The number in the image file name may not correspond to the frame number of the image. As images are deleted in the camera, the frame counter will adjust itself to show the number of images on the card and reassign the frame numbers accordingly. The serial numbers used with image files will not change when an image is deleted. When a new image is recorded, it will be assigned a number one greater than the largest serial number in the folder. File serial numbers can be controlled with the file-number-memory function in the custom 1 section of the setup menu (p. 84).

## Camera Notes

Image files contain exif tag data. This data includes the time and date the image was recorded as well as the camera settings used. This data can be viewed with the camera or the DiIMAGE Viewer software. If a camera image is opened in a photo-retouching application that does not support exif tags, such as Adobe Photoshop, and then the image is saved overwriting the original data, the exif tag information is erased. When using software other than the DiIMAGE Viewer, always make a backup copy of the image files to protect the exif tag data.

To view images correctly on your computer, the monitor's color space may need to be adjusted. Refer to your computer manual on how to calibrate the display to the following requirements: sRGB, with a color temperature of 6500K, and a gamma of 2.2. Changes made to the captured image with the camera's contrast and color-saturation controls will affect any color-matching software in use.

# DISCONNECTING THE CAMERA FROM THE COMPUTER



Never disconnect the camera when the access lamp is red - the data or memory card may permanently be damaged.

## *Windows 98 / 98 Second Edition*

Confirm that the access lamp is not lit. Turn off the camera and then disconnect the USB cable.

## *Windows Me, 2000 Professional, and XP*



To disconnect the camera, click once on the unplug-or-eject-hardware icon located on the task bar. A small window will open indicating the device to be stopped.

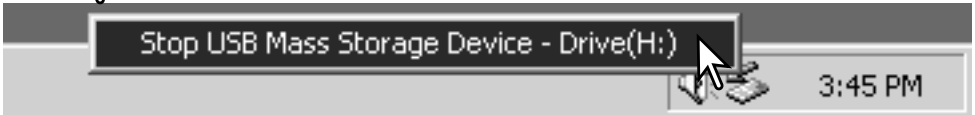

Click on the small window to stop the device. The safe-to-remove-hardware window will open. Close the window, turn the camera off, and then disconnect the USB cable.



When more than one external device are connected to the computer, repeat the procedure above except right click on the unplug-or-eject-hardware icon; a small window indicating the unplug-or-eject-hardware routine will open. Click on the small window.

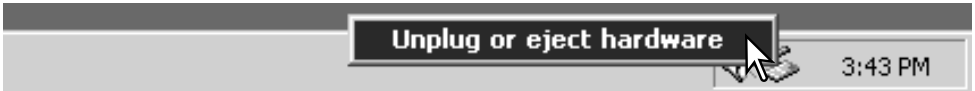

The hardware devices to be stopped will be displayed in the unplug-or-eject-hardware window. Highlight the device by clicking on it then click “Stop.”

A confirmation screen will appear to indicate the devices to be stopped. Click “OK” to stop the device.

A third and final screen will appear to indicate the camera can be safely disconnected from the computer. Close the window, turn the camera off, and then disconnect the USB cable.

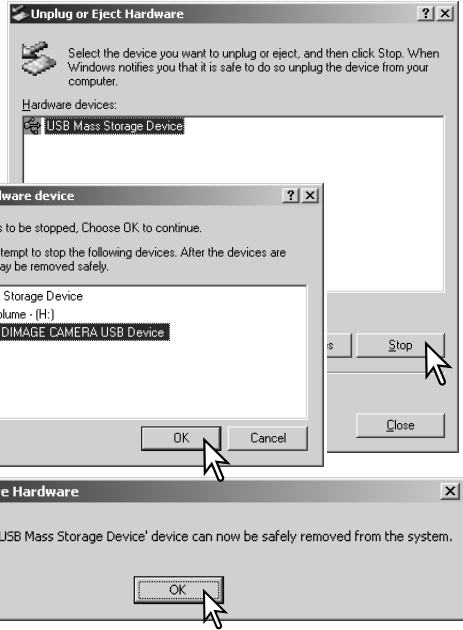

### Macintosh

Confirm that the access lamp is not lit and then drag the mass-storage device icon and drop it into the trash. Turn the camera off, and then disconnect the USB cable.



## CHANGING THE COMPACTFLASH CARD - DATA-TRANSFER MODE



Never remove a memory card when the access lamp is red - the data or memory card may permanently be damaged.

### *Windows 98 and 98 Second Edition*

1. Turn off the camera.
2. Change the CompactFlash card.
3. Turn the mode dial to the data-transfer position to remake the USB connection.

### *Windows ME, 2000 professional, and XP*

1. Stop the USB connection using the unplug-or-eject-hardware routine (p. 100).
2. Turn off the camera.
3. Change the CompactFlash card.
4. Turn the mode dial to the data-transfer position to remake the USB connection.

### *Macintosh*

1. Stop the USB connection by dragging the drive icon into the trash (p. 101).
2. Turn off the camera.
3. Change the CompactFlash card.
4. Turn the mode dial to the data-transfer position to remake the USB connection.

## AUTO POWER SAVE - DATA-TRANSFER MODE

If the camera does not receive a read or write command within ten minutes, it will shut down to save power. When the camera shuts down, an unsafe-removal-of-device warning may appear on the computer monitor. Click "OK." Neither the camera or computer will be damaged in this operation.

Turn off the camera with the mode dial. Remake the USB connection by turning the mode dial back to the data-transfer position.

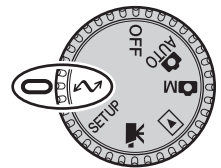

## QUICKTIME SYSTEM REQUIREMENTS

IBM PC / AT Compatible
Pentium-based computer
Windows 95, 98, 98SE, NT, Me, or 2000 Professional.
32MB or more of RAM
Sound Blaster or compatible sound card
DirectX 3.0 or later recommended

QuickTime is used for viewing movie clips and playing voice-memo audio files. To install QuickTime, follow the instructions in the installer. Macintosh users can download the latest version of QuickTime free of charge from the Apple Computer web site: <http://www.apple.com>.

## TROUBLESHOOTING

The section covers minor problems with basic camera operation. For major problems or damage, or if a problem continues to reoccur frequently, contact a Minolta service facility listed on the back cover of this manual.

Problem	Symptom	Cause	Solution
The camera will not work.	Nothing displayed on the data panel or the monitors.	The batteries are dead.	Replace batteries (p. 16).
		The batteries are inserted incorrectly.	Reinsert the batteries taking care that the negative and positive terminals are oriented as indicated on the inside of the battery chamber door (p.16).
		The AC adapter is not connected properly.	Check that the adapter is connected to the camera and a live electrical outlet (p. 18).
	The camera was accidentally turned on while in a bag or case, or the lens was hindered while extending.	Turn the camera off and on to restore operation.	

Problem	Symptom	Cause	Solution
Shutter will not release.	"000" is displayed on the frame counter.	CompactFlash card is full and unable to store an image at the image-quality or image-size setting on the camera.	Insert a new CompactFlash card (p. 18), delete some images (p. 76), or change the image-quality or image-size setting (p. 44).
	No-card warning appears on the monitors.	No CompactFlash card in the camera.	Insert a CompactFlash card (p.18).
Pictures are not sharp.	Focus signal is red.	Subject is too close.	Make sure the subject is within the autofocus range (p. 26) or use the macro mode (p. 28).
		The camera is in macro mode.	Cancel the macro mode setting (p. 28).
		A special situation is preventing the autofocus system from focusing (p.27)	Use the focus-lock function to focus on an object at the same distance as the subject (p. 26) or use manual focus (p. 59).
	Pictures are taken indoors or in low-light situations without flash.	Slow shutter speeds result in blurred images when the camera is handheld.	Use a tripod, change the camera sensitivity to a higher setting (p. 62), or use the flash (p. 30).
Continuous advance does not work.	The image quality is set to TIFF.		Change the image-quality setting (p. 44).



Problem	Symptom	Cause	Solution
While using flash, the pictures are too dark.	The subject is beyond the flash range (p. 62).		Move closer to the subject or change the camera sensitivity to a higher setting (p. 62).
Shooting data is displayed, but live image is entirely black or white.	Camera set to manual-exposure mode (M).	Shutter speed and aperture combination is extremely under or over-exposing the live image.	Change the shutter speed or aperture value until an image appears on the monitor (p. 57).
“Err” displayed on the data panel.	Turn off the camera and remove the batteries or unplug the external power supply. Wait for the message to disappear before reinserting the batteries or plugging in the power supply. If the camera is hot, allow it to cool before removing the batteries and Compactflash card.		

If the camera does not function normally, turn it off, remove and reinsert the batteries, or unplug and reconnect the AC adapter. Always turn the camera off using the mode dial otherwise the CompactFlash card may be damaged and camera settings reset. The camera temperature rises with extended periods of use. Care should be taken to avoid burns when handling the camera, batteries, or CompactFlash card.

## ABOUT NI-MH BATTERIES

When using Ni-MH batteries, clean both battery terminals with dry cloth to wipe off any dirt or residue. Because of the sophisticated computer system, the camera critically monitors power levels. If the battery terminals are dirty, the camera may give a false low-battery warning. If battery performance is unusually low, wipe the battery terminals with a clean, dry cloth.

Ni-MH battery performance will decrease if the batteries are often recharged before they have been fully discharged. Completely exhaust the Ni-MH batteries using the camera before charging.

## REMOVING THE DRIVER SOFTWARE - WINDOWS

1. Insert a memory card in the camera and connect it to the computer with the USB cable. Other devices must not be connected to the computer during this procedure.

2. Right click on the My-computer icon. Select “properties” from the drop-down menu.

Windows XP: from the start menu go to the control panel. Click on the performance and maintenance category. Click “System” to open the system properties window.

3. Windows 2000 and XP: select the hardware tab in the properties window and click the device-manager button.

Windows 98 and Me: click the device-manager tab in the properties window.

4. The driver file will be located in the universal-serial-bus-controller or other-devices location of the device manager. Click on the locations to display the files. The driver should be indicated with the camera name. Under certain conditions, the driver name may not contain the camera name. However, the driver will be indicated by either a question mark or exclamation point.

5. Click on the driver to select it.

6. Windows 2000 and XP: click on the action button to display the drop-down menu. Select “uninstall.” A confirmation screen will appear. Clicking “Yes” will remove the driver from the system.

Windows 98 and Me: click the remove button. A confirmation screen will appear. Clicking “Yes” will remove the driver from the system.

7. Disconnect the USB cable and turn off the camera. Restart the computer.

# CARE AND STORAGE

## CAMERA CARE

- Do not subject the camera to shock or impact.
- Turn off the camera when transporting.
- This camera is neither waterproof nor splashproof. Inserting or removing batteries or the CompactFlash card, or operating the camera with wet hands may damage the camera.
- When at the beach or near water, take care not to expose the camera to water or sand. Water, sand, dust, or salt can damage the camera.
- Do not leave the camera under direct sunlight. Do not point the lens directly at the sun; the CCD may be damaged.

## CLEANING

- If the camera or the outside of the lens is dirty, gently wipe it with a soft, clean, dry cloth. If the camera or lens comes in contact with sand, gently blow away loose particles. Wiping may scratch the surface.
- To clean the lens surface, first blow away any dust or sand, then gently wipe the lens with a cloth or tissue designed for optics. Use lens-cleaning fluid if necessary.
- Never use organic solvents to clean the camera.
- Never touch the lens surface with your fingers.

## STORAGE

- Store in a cool, dry, well-ventilated area away from dust and chemicals. For long periods of disuse, store the camera in an airtight container with a silica-gel drying agent.
- Remove the batteries and CompactFlash card from the camera when not in use for extended periods.
- Do not store the camera in an area with naphthalene or mothballs.
- During long periods of storage, operate the camera occasionally. When taking the camera out of storage, check that the camera is functioning properly before using.

#### LCD MONITOR CARE

- Although the LCD monitor is manufactured using high precision technology, there may occasionally be a lack of color or bright points on the LCD monitor.
- Do not apply pressure to the surface of the LCD monitor; it may be permanently damaged.
- In a cold environment, the LCD monitor may become temporarily dark. When the camera warms up, the display will function normally.
- The LCD monitor may be slow to react in low temperatures or may turn dark in a hot environment. When the camera reaches normal operating temperature, the display will function normally.
- If fingerprints are on the LCD monitor surface, gently wipe with a soft, clean, dry cloth.

#### OPERATING TEMPERATURES AND CONDITIONS

- This camera has been designed for use in temperatures from 0°C to 40°C (32°F to 104°F).
- Never leave the camera exposed to extreme high temperatures, such as in a car parked in the sun, or to extreme humidity.
- When taking the camera from a cold to a warm environment, place it in a sealed plastic bag to prevent condensation from forming. Allow the camera to come to room temperature before removing it from the bag.

#### BEFORE IMPORTANT EVENTS OR JOURNEYS

- Check the camera's operation; take test pictures and purchase spare batteries.
- Minolta has no responsibility for any damage or loss incurred by equipment malfunction.

#### COPYRIGHT

- TV program, films, video tapes, photographs, and other materials may be copyrighted. Unauthorized recording or duplication of such material may be contrary to copyright laws. Taking pictures or images of performances, exhibitions, etc., is prohibited without approval and can infringe on copyright. Images protected by copyright can only be used under the provisions within the copyright laws.

## BATTERIES

- Battery performance decreases with temperature. In cold environments, we recommend keeping spare batteries in a warm place, such as the inside of a coat. Batteries can recover their power when they warm up. As the performance of Ni-MH batteries are less affected by temperature, their use is recommended when shooting in cold environments.
- Remove the batteries when the camera is not in use for an extended period. Leaking battery fluid may damage the battery-chamber.
- Occasionally, when using alkaline batteries, the battery-condition indicator will give a false low-battery-power warning, even though there is enough power capacity. Continue to use the camera; the low-battery indicator will disappear.
- If batteries have been exhausted when used in the camera, do not reload them even if their charge seems to recover over time. These batteries will interfere with normal camera operation.

## COMPACTFLASH CARD CARE AND HANDLING

CompactFlash Cards are manufactured with precision electronic components. The following may cause data loss or damage:

- Improper use of the card.
- Bending, dropping, or subjecting the card to impact.
- Heat, moisture, and direct sunlight.
- Static electrical discharge or electromagnetic fields near the card.
- Removing the card or interrupting the power supply while the camera or a computer is accessing the card (reading, writing, formatting, etc.).
- Touching the electrical contacts of the card with your fingers or metal objects.
- Using the card beyond its life. Purchasing a new card periodically may be necessary.

Minolta has no responsibility for any loss or damage to data. It is recommended that a copy of the card data be made.

## QUESTIONS AND SERVICE

- If you have questions about your camera, contact your local camera dealer or write to the Minolta distributor in your area.
- Before shipping your camera for repair, contact a Minolta Service Facility.

## TECHNICAL SPECIFICATIONS

Number of effective pixels:	4.0 million
CCD:	1/1.8-type interline primary-color CCD with a total of 4.1 million pixels.
Camera sensitivity (ISO):	Auto and 64, 100, 200, and 400 ISO equivalents.
Aspect ratio:	4:3
Lens construction:	11 elements in 9 groups including one AD glass and two double-sided aspheric elements.
Maximum aperture:	f/3.0 (wide-angle position), f/3.6 (telephoto position)
Focal length:	7.15 - 28.6 mm (35mm equivalent: 35 - 140 mm)
Focusing range (from the CCD):	0.5 m (1.6 ft.) - infinity (wide-angle position) 0.9 m (3.0 ft.) - infinity (telephoto position) 0.16 - 0.6 m (0.5 - 2.0 ft.) in macro mode
Filter diameter:	35.5 mm
Autofocusing system:	Video AF
Shutter:	CCD electronic shutter plus mechanical shutter
Shutter speeds:	1/1000 - 4s, bulb (15s maximum)
Built-in flash recycling time:	8s (approx)
Viewfinder:	Optical real-image zoom viewfinder.
Monitor LCD:	46 mm TFT color
Monitor field of view:	Approximately 100%
A/D conversion:	12 bits
Recording media:	Type I CompactFlash cards
File formats:	JPEG, TIFF, motion JPEG (mov), WAV. DCF 1.0 and DPOF compliant.
Printing output control:	Exif print, PRINT Image Matching II
Menu languages:	Japanese, English, German, French, and Spanish
Video output:	NTSC and PAL

Batteries:	4 AA Ni-MH or alkaline batteries. Ni-MH batteries are recommended over alkaline.
Battery performance (recording):	Approximately 160 frames. Based on Minolta's standard test method: 1,850mAh Ni-MH batteries, LCD monitor on, full-size images (2272 X 1704), standard image quality, no instant playback, no voice memo, flash used with 50% of the frames. Approximately 300 frames: based on Minolta's standard test method: 1,850mAh Ni-MH batteries, LCD monitor off, full-size images (2272 X 1704), standard image quality, no instant playback, no voice memo, flash used with 50% of the frames.
Battery performance (playback):	Approx. continuous playback time: 120 min. Based on Minolta's standard test method: 1,850mAh Ni-MH batteries, LCD monitor on.
External power source:	AC adapter (AC-1L or AC-2L) High-power battery pack (EBP-100)
Dimensions:	113.5 (W) X 64.5 (H) X 58.5 (D) mm 4.47 (W) X 2.54 (H) X 2.30 (D) in.
Weight:	Approximately 335g (11.8 Oz.) (without batteries or CompactFlash card)
Operating temperature:	0° - 40°C
Operating humidity:	5 - 85% (noncondensing)

Specifications are based on the latest information available at the time of printing and are subject to change without notice.



**Minolta Customer Support:**  
**[www.minoltasupport.com](http://www.minoltasupport.com)**

© 2003 Minolta Co., Ltd. under the Berne Convention  
and the Universal Copyright Convention.

0-43325-53187-3

9222-2799-11 PR-A212/ME0302  
Printed in Germany