

MINOLTA

The essentials of imaging

www.minoltaeurope.com



***Di*IMAGE® X**

9224-2776-11 H-A112

E INSTRUCTION MANUAL

BEFORE YOU BEGIN

Thank you for purchasing this Minolta product. Please take the time to read through this instruction manual so you can enjoy all the features of your new digital camera.

This manual contains information regarding products introduced before February, 2002. To obtain compatibility information for products released after this date, contact a Minolta Service Facility listed on the back cover of this manual.

Check the packing list before using this product. If any items are missing, immediately contact your camera dealer.

Minolta DiIMAGE X digital camera
Lithium-ion battery NP-200
Lithium-ion battery charger BC-200
Hand strap HS-DG100
8MB SD Memory Card
AV cable AVC-200
USB cable USB-500
DiIMAGE software CD-ROM for DiIMAGE X
PDF DiIMAGE Image Viewer Utility manual on CD-ROM
PDF Camera manual on CD-ROM
Quick Reference Guide
Warranty card

Do not remove the ferrite cores from the cables.

Apple, the Apple logo, Macintosh, Power Macintosh, Mac OS, and the Mac OS logo are registered trademarks of Apple Computer Inc. Microsoft and Windows are registered trademarks of the Microsoft Corporation. The official name of Windows is Microsoft Windows Operating System. Pentium is a registered trademark of the Intel Corporation. Power PC is a trademark of the International Business Machines Corporation. QuickTime is a trademark used under license. All other trademarks are the property of their respective owners.

NP-200 Lithium-ion batteries

The DiMAGE X operates on a small, but powerful lithium-ion battery. Misuse or abuse of the lithium-ion battery can cause damage or injury through fire, electric shock, or chemical leakage.

Read and understand all warnings before using the battery.

DANGER

- Do not short, disassemble, damage, or modify the battery.
- Do not expose the battery to fire or high temperatures over 60°C (140°F).
- Do not expose the battery to water, or moisture. Water can corrode or damage the internal battery safety devices and cause the battery to overheat, ignite, rupture, or leak.
- Do not drop or subject the battery to strong impacts. Impacts can damage the internal battery safety devices and cause the battery to overheat, ignite, rupture, or leak.
- Do not store the battery near or in metallic products.
- Only use the battery specified in this camera manual.
- Only use the specified charger within the voltage range specified on the charger unit. An inappropriate charger or current may cause damage or injury through fire or electric shock.
- Do not use a leaking battery. If fluid from the battery enters your eye, immediately rinse the eye with plenty of fresh water and contact a doctor. If fluid from the battery makes contact with your skin or clothing, wash the area thoroughly with water.

(Continued on the next page.)



WARNING

- Tape over the lithium-ion battery contacts to avoid short-circuiting during disposal; always follow local regulations for battery disposal.
- Only use the battery specified in this manual.
- If charging is not completed after the specified period elapses, unplug the charger and discontinue charging immediately.
- Only use or charge the battery in an environment with ambient temperatures between 0° and 40°C (32° and 104°F) and a humidity of 45% to 85% RH. Only store the battery in an environment with ambient temperatures between -20° and 30°C (-4° and 86°F) and a humidity of 45% to 85% RH.

General warnings and cautions for product use.

Read and understand the following warnings and cautions for safe use of the digital camera and its accessories.



WARNING

- Do not disassemble the camera or charger. Electric shock may cause injury if a high voltage circuit inside the product is touched.
- Immediately remove the battery or unplug the AC adapter and discontinue use if the camera is dropped or subjected to an impact in which the interior, especially the flash unit, is exposed. The flash has a high voltage circuit which may cause an electric shock resulting in injury. The continued use of a damaged product or part may cause injuries or fire.
- Keep the battery, memory card, or small parts that could be swallowed away from infants. Contact a doctor immediately if an object is swallowed.
- Store this product out of reach of children. Be careful when around children, not to harm them with the product or parts.
- Do not fire the flash directly into the eyes. It may damage eyesight.
- Do not fire the flash at vehicle operators. It may cause a distraction or temporary blindness which may lead to an accident.

-
- Do not use the monitor while operating a vehicle or walking. It may result in injury or an accident.
 - Do not use this product in a humid environment, or operate these products with wet hands. If liquid enters this product, immediately remove the battery or unplug the power cord, and discontinue use. The continued use of a product exposed to liquids may cause damage or injury through fire or electric shock.
 - Do not use this product near inflammable gases or liquids such as gasoline, benzine, or paint thinner. Do not use inflammable products such as alcohol, benzine, or paint thinner to clean these products. The use of inflammable cleaners and solvents may cause an explosion or fire.
 - When unplugging the AC adapter or charger, do not pull on the power cord. Hold the plug when removing it from an outlet.
 - Do not damage, twist, modify, heat, or place heavy objects on the AC adapter or charger cord. A damaged cord may cause damage or injury through fire or electric shock.
 - If these products emit a strange odor, heat, or smoke, discontinue use. Immediately remove the battery taking care not to burn yourself as the battery may become hot with use. The continued use of a damaged product or part may cause injuries or fire.
 - Only use the specified AC adapter within the voltage range indicated on the adapter unit. An inappropriate adapter or current may cause damage or injury through fire or electric shock.
 - Take the product to a Minolta Service Facility when repairs are required.



CAUTION

- Do not use or store these product in a hot or humid environment such as the glove compartment or trunk of a car. It may damage the camera, charger, and battery which may result in burns or injuries caused by heat, fire, explosion, or leaking battery fluid.
- If the battery is leaking, discontinue use of the product.
- The camera, charger, and battery temperature rises with extended periods of use. Care should be taken to avoid burns.
- Burns may result if the memory card or battery is removed immediately after extended periods of use. Turn the camera off and wait for it to cool.
- Do not fire the flash while it is in contact with people or objects. The flash unit discharges a large amount of energy which may cause burns.
- Do not apply pressure to the LCD monitor. A damaged monitor may cause injury, and the liquid from the monitor may cause inflammation. If liquid from the monitor makes contact with skin, wash the area with fresh water. If liquid from the monitor comes in contact with the eyes, immediately rinse the eyes with plenty of water and contact a doctor.
- When using the AC adapter and charger, insert the plug securely into the electrical outlet.
- Do not use if the AC adapter or charger cord is damaged.
- Do not cover the AC adapter or charger. A fire may result.
- Do not obstruct access to the AC adapter or charger; this can hinder the unplugging of the units in emergencies.
- Unplug the AC adapter or charger when cleaning or not in use.

ABOUT THIS MANUAL

The getting up and running section covers how to prepare the camera for use. It contains important information about power supplies and memory cards. The basic operation of this camera is covered in the recording-mode section between pages 20 and 29, and the playback-mode section between pages 50 and 56. Read the data-transfer mode section in its entirety before connecting the camera to a computer.

Many of the features of this camera are controlled with menus. The menu navigation sections concisely describe how to change menu settings. Descriptions of the settings immediately follow the navigation sections.

The appendix contains a troubleshooting section to help answer questions about the operation of the camera. Information covering camera care and storage is also provided. Please store this manual in a safe place.

Names of parts	10
Getting up and running.....	12
Charging the lithium-ion battery	12
Changing the lithium-ion battery.....	13
Battery-condition indicator	14
Auto power off	14
AC adapter (sold separately).....	15
Attaching the hand strap	15
Installing and removing a memory card	16
About memory cards	17
Setting the date and time	18
Recording mode	20
Handling the camera	20
Setting the camera to record images	20
Using the zoom lens.....	21
LCD monitor display - recording mode.....	22
Camera-shake warning	22
Basic recording operation.....	23
Focus lock	24
Focus range.....	24

TABLE OF CONTENTS

Focus signals.....	25
Special focusing situations.....	25
Flash modes.....	26
Flash range.....	27
Flash signals.....	27
Navigating the recording-mode menu.....	28
Drive modes.....	30
Single-frame advance.....	30
Continuous advance.....	31
Self-timer.....	32
Movie recording.....	33
Audio recording.....	34
Image size.....	35
Image quality.....	36
The frame counter and memory card capacity.....	37
White balance.....	38
Automatic white balance.....	38
Preset white balance.....	39
Digital zoom.....	40
Instant playback.....	41
Voice memo.....	42
Folder name.....	43
LCD brightness.....	44
Auto-power-off menu settings.....	44
Audio signals.....	44
Setting the date and time.....	45
Setting the date format.....	45
Exposure compensation.....	46
What is an Ev?.....	47
Display button - recording mode.....	48
A short guide to photography.....	49
Playback mode.....	50
Single-frame playback display.....	50
Viewing images and playing back audio recordings.....	51
Display button - playback mode.....	52
Enlarged playback.....	53
Navigating the playback-mode menu.....	54
Frame-selection screen.....	56

Audio captioning	57
Deleting image and audio files	58
Locking image and audio files	59
About DPOF	60
Creating a DPOF print order	60
Ordering an index print	61
Formatting memory cards	62
Video output	62
Language	62
Viewing images on a television	63
Data-transfer mode	64
DiIMAGE X system requirements	64
Connecting the camera to a computer	65
Connecting to Windows 98 and 98SE	67
Automatic installation	67
Manual installation	68
Connecting to Mac OS 8.6	70
QuickTime system requirements	70
Auto power off – data-transfer mode	70
Changing the memory card - data-transfer mode	71
Memory card folder organization	72
Disconnecting the camera from the computer	74
Windows 98 and 98SE	74
Windows Me, 2000 Professional, and XP	74
Macintosh	75
Appendix	76
Setting the menu language	76
Troubleshooting	77
Care and storage	82
Technical specifications	86

NAMES OF PARTS

* This camera is a sophisticated optical instrument. Care should be taken to keep these surfaces clean. Please read the care and storage instructions in the back of this manual (p. 82).

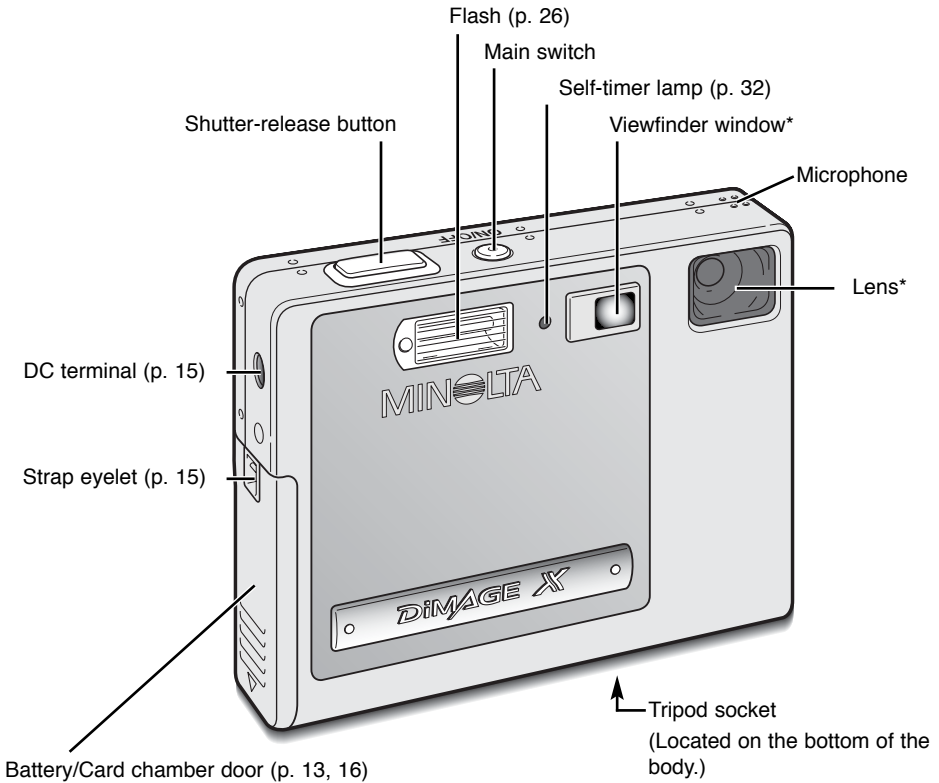

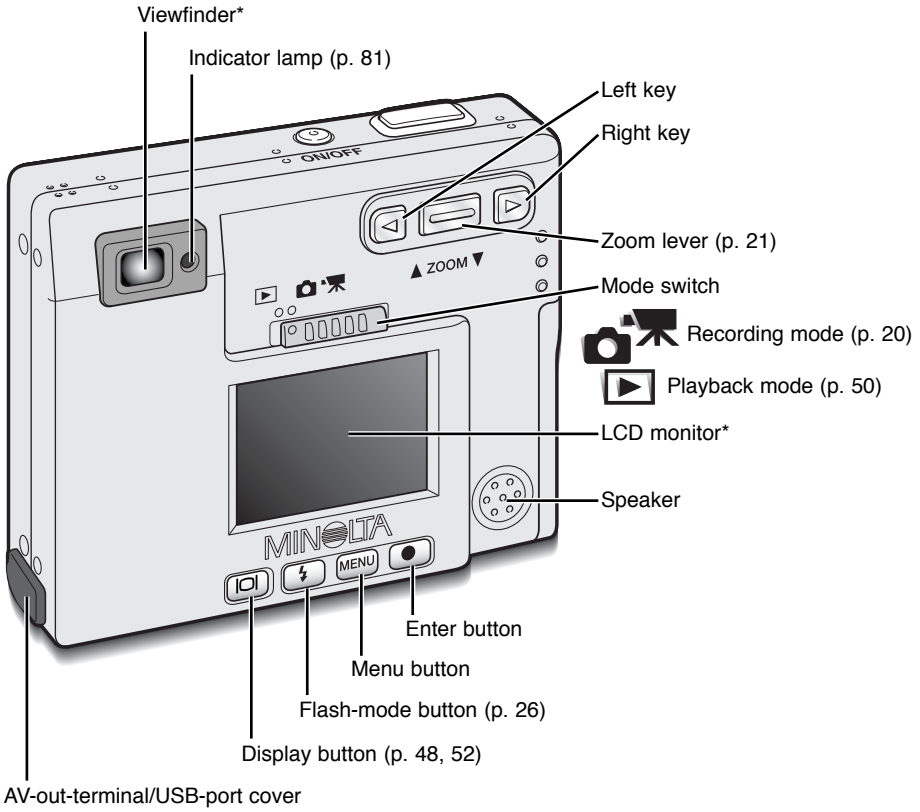

GETTING UP AND RUNNING

This section covers how to prepare your camera for use. Details on the use and installation of the battery and memory card are given as well as how to attach the hand strap and optional AC adapter.

Charging the lithium-ion battery

Before the camera can be used, the lithium-ion battery must be charged. Before charging the battery, read the safety warnings on pages 3 and 4 of this manual. Only recharge the battery with the supplied battery charger. The battery should be recharged before each shooting session. See page 83 for battery care and storage.

Plug the power cord into the charger unit (1).

With the battery terminals toward the front and the label face up, slide the battery into the charger (2).

Plug the charger into a live household outlet.

- After a few seconds, the indicator lamp (3) will glow to show the battery is charging. The lamp will go out when the battery has been charged. Charging time is approximately eighty minutes.

Unplug the power cord from the outlet.

Remove the battery from the charger (4).

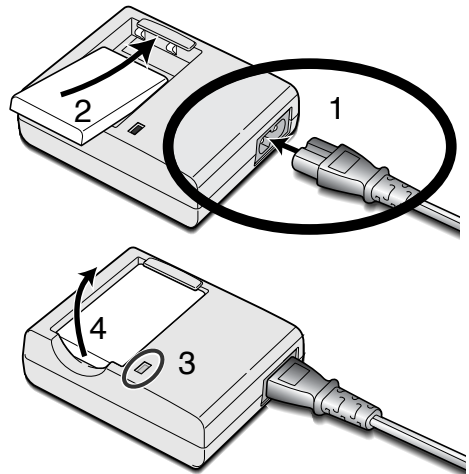

Changing the lithium-ion battery

This digital camera uses one NP-200 lithium-ion battery. Before using the battery, read the safety warnings on pages 3 and 4 of this manual. When replacing the battery, the camera should be turned off.

Slide the battery-chamber door toward the bottom of the camera to release the safety catch (1). Open the door (2).

Move the battery latch towards the back of the camera to insert the battery (3). Slide the battery into the battery chamber (4) with the battery terminals first until it is caught by the latch.

To remove the battery, move the latch towards the back of the camera until the battery is released (5). Pull the battery out of the chamber (6).

Close the battery-chamber door (7) and slide it toward the top of the camera to engage the safety catch (8).

- After installing the battery, the set-time/date message may appear on the monitor. The clock and calendar is set in the setup 1 section of the menu (p. 18).

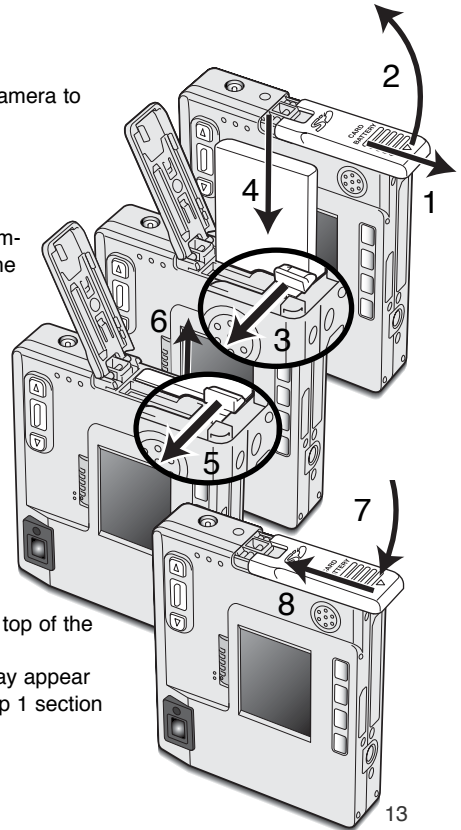

Battery-condition indicator

This camera is equipped with an automatic battery-condition indicator displayed on the LCD monitor. The icon will change from white to red when battery power is low.



Full-battery icon - the battery is fully charged. This icon is displayed for three seconds when the camera is switched on or switched between the recording or playback mode.



Half-full-battery icon - the battery is partially charged. This icon is displayed for three seconds. The LCD monitor will turn off when the flash is charging.



Low-battery warning - battery power is very low. The battery should be replaced as soon as possible. This warning automatically appears and remains on the monitor until the battery is recharged. If the power level falls below this level when the camera is on, the battery-exhausted message will appear just before the camera shuts down.

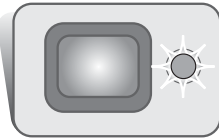

If power is insufficient for camera operation, the indicator lamp next to the viewfinder will turn red and blink for three seconds. The shutter will not release. The battery must be recharged.

Auto power off

To conserve battery power, the camera will shut down if an operation is not made within three minutes. To restore power, press the main switch. The length of the auto-power-off period can be changed in the setup 1 section of the recording and playback-mode menu (p. 28, 54). When the camera is connected to a computer, the auto-power-off period is set to ten minutes and cannot be changed.

AC adapter (sold separately)

Do not change the power supply while the camera is on.
Always turn off the camera before changing between power supplies.

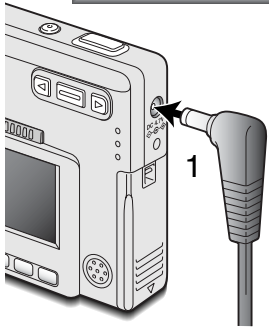

The AC adapter AC-4 or AC-5 allows the camera to be powered from a household outlet. The AC adapter is recommended when the camera is interfaced with a computer or during periods of heavy use. AC adapter model AC-4 is for use in North America, Japan, and Taiwan, and AC-5 is for use in all other areas.

Insert the mini plug of the AC adapter into the DC terminal (1).

Insert the AC adapter plug into an electrical outlet.

Attaching the hand strap

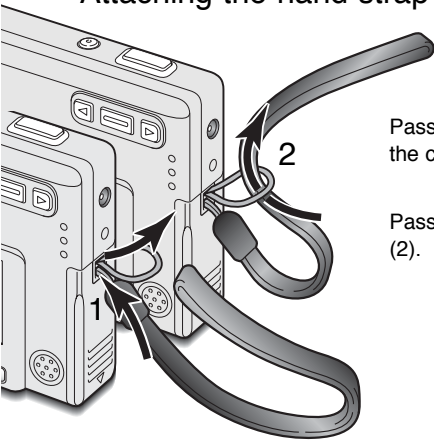

Always keep the strap around your wrist in case that the camera is accidentally dropped.

Pass the small loop of the hand strap through the strap eyelet on the camera body (1).

Pass the other end of the strap through the small loop and tighten (2).

Installing and removing a memory card

Always turn off the camera and confirm the indicator lamp is not orange and blinking before changing the memory card, otherwise the card may be damaged, and data lost.

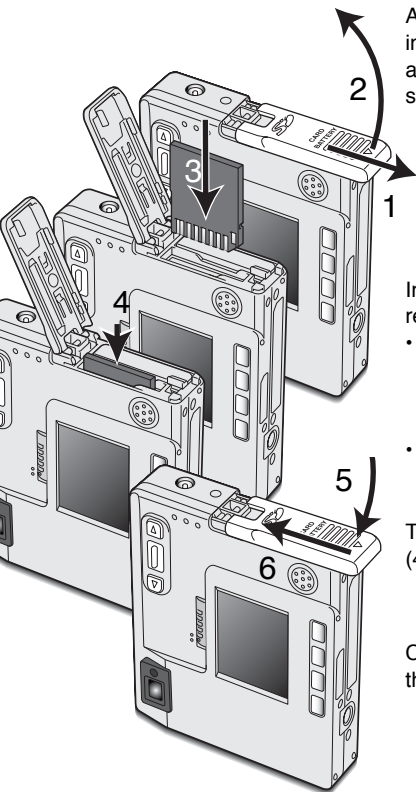

An SD (Secure Digital) Memory card or MultiMediaCard must be inserted for the camera to operate. If a card has not been inserted, a no-card warning will appear on the LCD monitor; the shutter can still be released.

Slide the battery-chamber door toward the bottom of the camera to release the safety catch (1). Open the door (2).

Insert the memory card all the way into the card slot and then release (3). The card should catch in the slot.

- Insert the card so the face is toward the front of the camera. Always push the card in straight, never at an angle. Never force the card. If the card does not fit, check that it is orientated correctly.
- If a MultiMediaCard is inserted incorrectly, it will lock, but the card chamber door will not close.

To eject a memory card, press the card into the slot and release (4). The card can now be pulled out.

Close the battery-chamber door (5) and slide it toward the top of the camera to engage the safety catch (6).

About memory cards

The response time during recording and playback is longer with MultiMediaCards compared with SD Memory Cards. This is not a defect, but rather due to the specifications of the cards. When using large capacity cards, some operations like deletion may take longer.

The SD Memory Card has a write-protect switch to prevent image data from being deleted. By sliding the switch to the bottom of the card, the data will be protected. However, when the card is protected, images cannot be recorded. If an attempt is made to record or delete an image with the camera, the card-locked message will appear and the LED lamps near the viewfinder will turn red and blink quickly. For memory card care and store see page 82.

If the unable-to-use-card message appears, the inserted card in the camera may need to be formatted. A card used in another camera may also have to be formatted before being used. A card can be formatted in the setup 2 section of the playback menu (p. 54). When a card is formatted, all the data on the card is permanently erased.

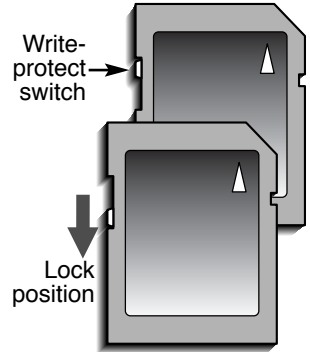

Setting the date and time

After initially inserting a memory card and charging the battery, the camera's clock and calendar must be set. When images are recorded, the image data is saved with the date and time of recording. Depending on the region, the menu language may also have to be set. To change the language, refer to page 76.

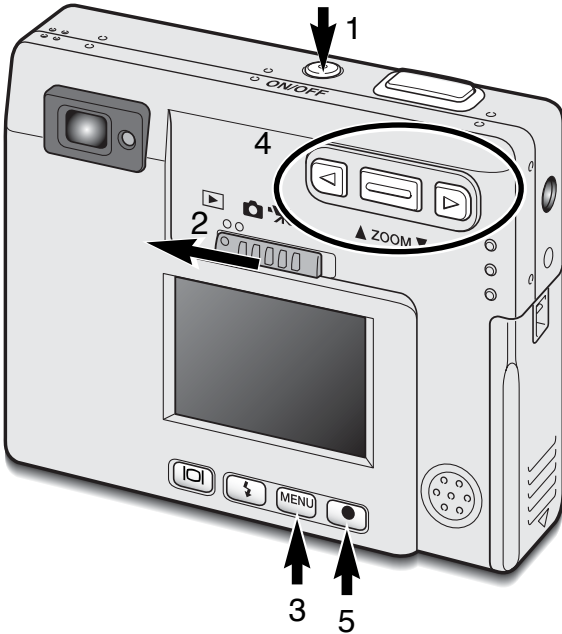

Turn the camera on by pressing the main switch near the shutter-release button (1).

Slide the mode switch to the playback position (2).

The date and time can be set on the playback menu. Navigating the menu is simple. The menu button (3) turns the menu on and off. The zoom lever and left and right keys (4) control the cursor and change settings on the menu. The enter button (5) selects menu options and sets adjustments.

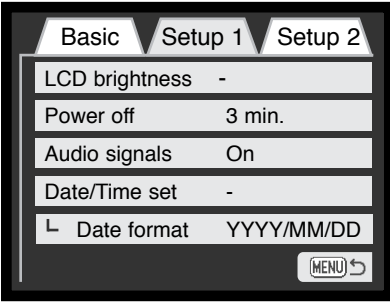

Playback menu: setup 1 section



Press the menu button to activate the playback menu.



Use the right key to highlight the setup 1 tab at the top of the menu.



Use the zoom lever to highlight the date/time-set menu option.



Press the right key. "Enter" will appear on the right side of the menu.

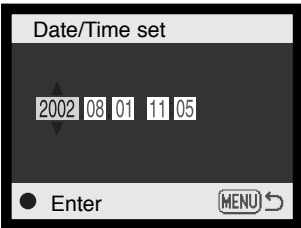

Date/Time setting screen



Press the enter button to display the date/time setting screen.



Use the left and right keys to select the item to be changed. Use the zoom lever to adjust the item.



Press the enter button to set the clock and calendar. The playback menu will be displayed.



Press the menu button to close the playback menu.

RECORDING MODE

This section covers the basic recording operation as well as advanced recording functions. To start using the camera, read pages 20 through 29. Many of the recording functions are controlled with menus. The menu navigation sections concisely describe how to change menu settings. Descriptions of the settings immediately follow the navigation section.

Handling the camera

While using the viewfinder or LCD monitor, grip the camera firmly with your right hand while supporting the camera body with your left. Keep your elbows at your side and your feet shoulder-width apart to hold the camera steadily.

When taking vertical pictures, hold the camera so that the flash is above the lens with the shutter-release button to the top. Take care not to cover the lens with your fingers or the strap.

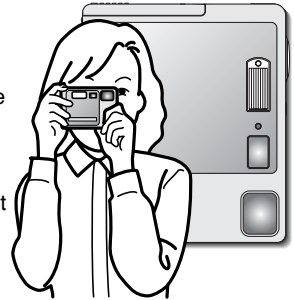

Setting the camera to record images

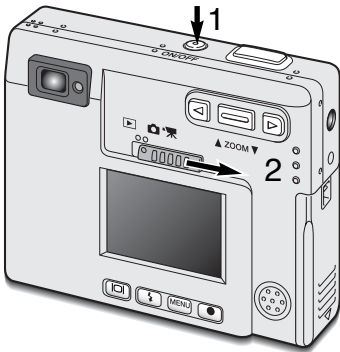

Turn the camera on by pressing the main switch (1).

Slide the mode switch to the recording position (2).

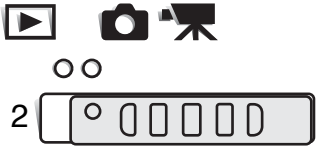

Using the zoom lens

This camera is equipped with a unique 5.7 - 17.1mm zoom lens. This is equivalent to a 37 to 111mm lens on a 35mm camera. The lens is controlled by the zoom lever at the back of the camera.

In 35mm photography, focal lengths below 50mm are referred to as wide-angle; the angle of view is larger than that of the human eye. Above 50mm is referred to as telephoto and makes distant objects appear closer. The effect of the optical zoom is visible in both the viewfinder and LCD monitor.



To zoom in on the subject, push the zoom lever up.

To zoom out, push the zoom lever down.

The digital-zoom function can double the power of the lens. The digital zoom is activated in the custom section of the recording-mode menu (p. 28).

LCD monitor display - recording mode

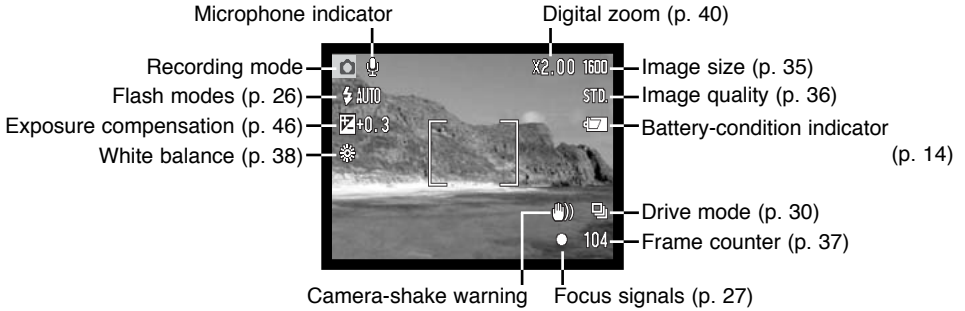

The frame counter cannot exceed 999. When the number of recordable images exceeds this, 999 will be displayed. The frame counter will continue to count down when the number of recordable images falls below one thousand.

Camera-shake warning



If the shutter speed falls below the point where the camera can be hand held safely, the camera-shake warning indicator will appear on the monitor and the viewfinder indicator lamp will turn green and blink slowly. Camera shake is slight blurring caused by subtle hand motion and is more pronounced at the telephoto position of the lens than at the wide-angle position. Although the warning appears, the shutter can still be released. If the warning appears, place the camera on a tripod or use the built-in flash.

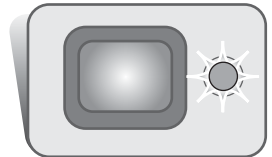

Basic recording operation

Turn the camera on and slide the mode switch to the recording position.

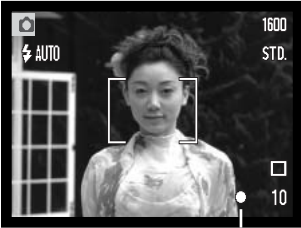

Place the subject within the focus frame on the LCD monitor or center the subject in the viewfinder.

- The focus-lock function (p. 24) can be used with off-center subjects.
- If the subject is closer than 1m (3ft.) at the zoom lens' wide-angle position or 3m (10ft) at the telephoto position, only use the LCD monitor to frame the subject.

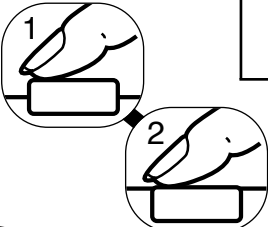

Press the shutter-release button partway down (1) to lock the focus and exposure.

- The focus signals (p. 25) on the monitor and the indicator lamp next to the viewfinder will confirm that the image is in focus. If the monitor focus signal is red or the indicator lamp is green and blinks quickly, the camera was unable to focus on the subject. Repeat the previous steps until the focus signal is white and the lamp glows steadily.

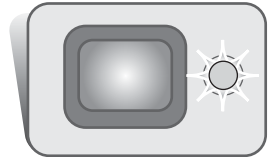

Press the shutter-release button all the way down (2) to take the picture.

- After the shutter releases, the indicator lamp next to the viewfinder will turn orange and blink indicating image data is being written to the memory card. Never remove a memory card while data is being transferred.

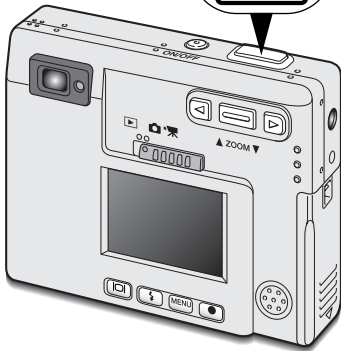

Focus lock

The focus-lock function is used when you want to compose the image with the subject off-center and outside the focus frame. Focus lock may also be used when a special focusing situation prevents the camera from focusing on the subject. This function is controlled with the shutter-release button.



Place the subject within the monitor focus frame or center the subject in the viewfinder. Press and hold the shutter-release button partway down to lock the focus.

- The focus signal on the monitor and the viewfinder indicator lamp will indicate if the focus is locked.

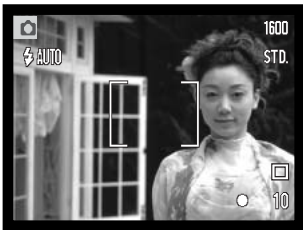
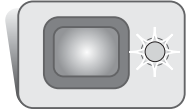

Without lifting your finger from the shutter-release button, re-compose the subject within the image area. Press the shutter-release button all the way down to take the picture.

Focus range

The focus range is 25cm (0.8ft.) to infinity. Both the LCD monitor and viewfinder can be used to frame the subject. However, because of parallax, only the monitor's live image will be accurate with subjects closer than 1m (3ft.) at the zoom lens' wide-angle position or 3m (10ft) at the telephoto position.

Focus signals

This digital camera has a quick, accurate autofocus system. The focus icon in the lower right corner of the LCD monitor and the indicator lamp next to the viewfinder indicate the focus status. The shutter can be released regardless of whether the camera can focus on the subject or not.

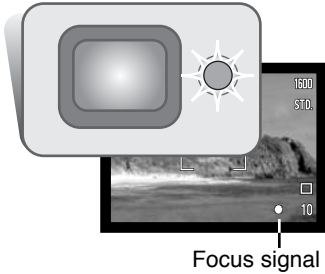

Focus confirmed - the LCD monitor focus signal is white and the viewfinder indicator lamp is green and steady.

Cannot focus - the LCD monitor focus signal is red and the viewfinder indicator lamp is green and blinking quickly. When the AF system cannot focus, the focus is set to 2m (6.5ft).

Special focusing situations

The camera may not be able to focus in certain situations. In these situations the focus-lock function (p. 24) can be used to focus on another object at the same distance as your main subject, and then the image can be recomposed to take the picture.

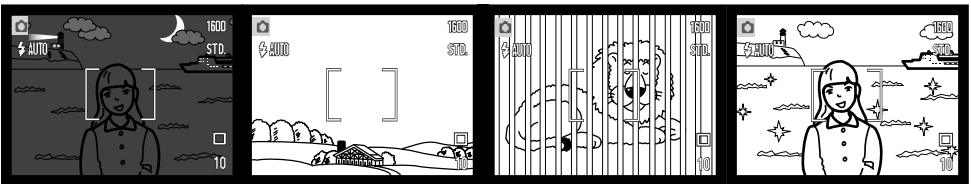

The subject is too dark.

The subject in the focus frame is low in contrast.

Two subjects at different distances overlap in the focus frame.

The subject is near a very bright object or area.

Flash modes

The flash can be used when taking still images. To set the flash mode, simply press the flash mode button (1) on the back of the camera until the desired mode is displayed. The active flash mode is displayed in the top left corner of the LCD monitor. When the camera is turned off, the flash mode is reset to autoflash with red-eye reduction if autoflash with red-eye reduction or night portrait was last set, if not the mode will be reset to autoflash.



The flash modes are displayed in the following order:

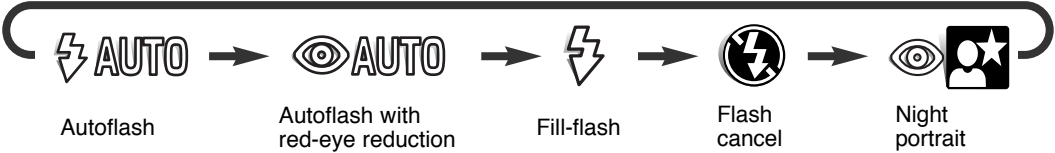

Autoflash - the flash fires automatically in low-light and backlit conditions.

Red-eye reduction - the flash fires multiple bursts before the main flash burst to reduce red-eye; an effect caused by light reflected from the retina. Use in low-light conditions when taking photographs of people or animals. The pre-flashes contract the pupils of the subject's eyes.

Fill-flash - the flash fires with each exposure regardless of the amount of ambient light. Fill-flash can be used to reduce harsh shadows caused by strong direct light or sunshine.



Flash cancel - the flash will not fire. Use flash cancel when flash photography is prohibited, natural light is desired to illuminate the subject, or the subject is beyond the flash range. The camera-shake warning may appear when flash cancel is selected (p. 22).

Night portrait - for flash portraits at night. The camera automatically balances the flash and background exposures. When taking portraits, ask your subject not to move after the flash burst; the shutter will still be open for the background exposure. The red-eye reduction function is used with night portrait. The use of a tripod is advised in conjunction with this feature.



Flash range

The camera automatically controls the flash output. For well-exposed images, the subject must be within the flash range. Because of the optical system, the flash range is not the same at the lens' wide-angle position as it is at the telephoto position.

Wide-angle position	Telephoto position
0.25m ~ 2.9m (0.8 ft. ~ 9.5 ft.)	0.25m ~ 2.3m (0.8 ft. ~ 7.5 ft.)

Flash signals

The indicator lamp next to the viewfinder indicates the status of the flash. When the lamp is red and blinks quickly, the flash is charging and the shutter will not release. When the lamp turns green, the flash is charged and ready to fire.

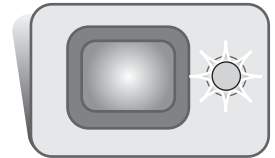



Navigating the recording-mode menu

Camera operations and recording functions are controlled on the menu. Navigating the menu is simple. The menu button turns the menu on and off. The zoom lever and left and right keys control the cursor and change settings on the menu. The enter button selects menu options and sets adjustments.

 To activate the recording-mode menu, press the menu button.

 The “Basic” tab at the top of the menu will be highlighted. Use the left/right keys to highlight the appropriate menu tab; the menus will change as the tabs are highlighted.

 When the desired menu section is displayed, use the zoom lever to scroll through the menu options. Highlight the option whose setting needs to be changed.

 With the menu option to be changed highlighted, press the right key; the settings will be displayed with the current setting indicated by an arrow.

- To return to the menu options, press the left key.

 Use the zoom lever to highlight the new setting.

- If “Enter” is displayed, press the enter button to display the setting screen.

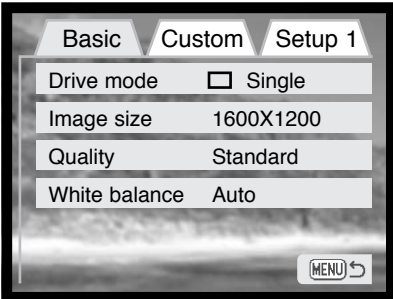

 Press the enter button to select the highlighted setting.

Once a setting has been selected, the cursor will return to the menu options and the new setting will be displayed. You can continue to make function changes. To return to the recording mode, press the menu button.

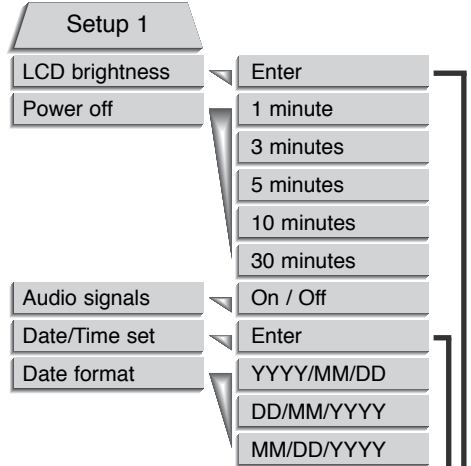
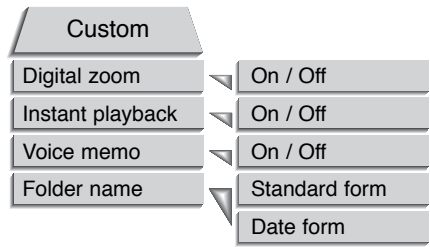
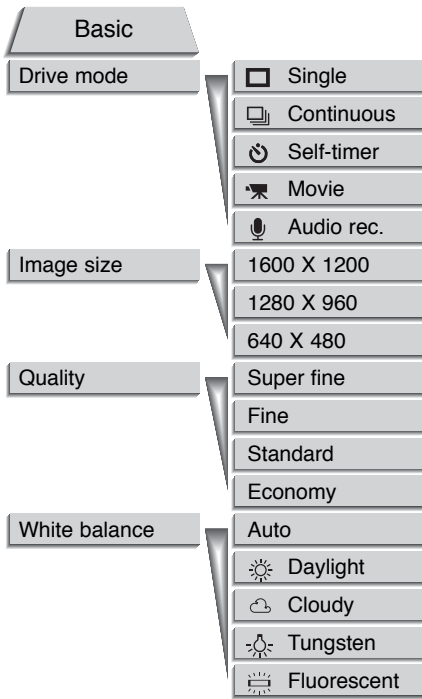

Refer to the following sections for details on the menu options and their settings. The setup 1 section can be accessed from both the recording-mode and playback menu (p. 54).



Drive modes

The drive modes control the rate and method images are captured. Icons indicating the selected drive mode appear on the monitor. The drive mode is selected in the basic section of the recording-mode menu (p. 28). When the camera is turned off, the drive mode is reset to single-frame advance.

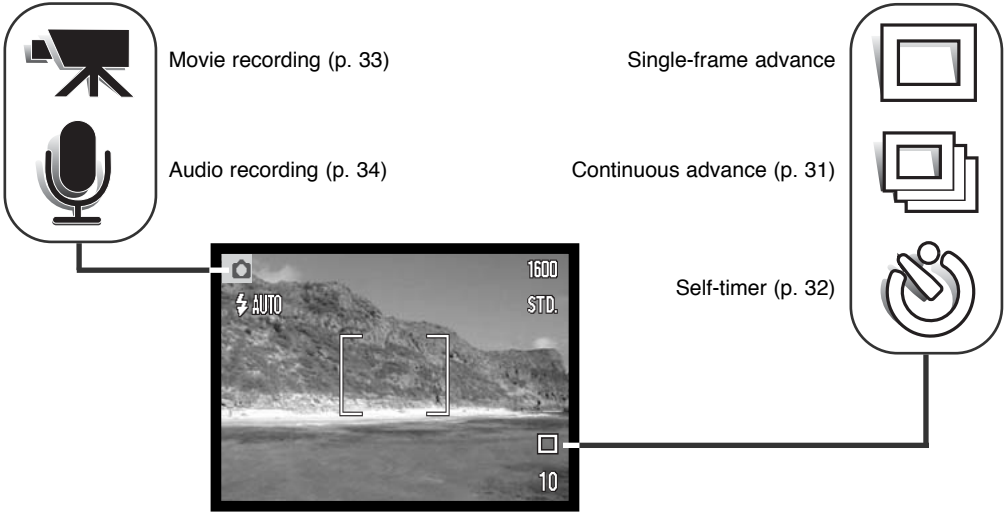

Single-frame advance



Single-frame advance allows only one image to be captured each time the shutter-release button is pressed. This is the camera's default setting.

Continuous advance



The continuous-advance drive mode allows a series of images to be captured while holding down the shutter-release button. The number of images that can be captured at one time and the rate of capture depend on the image-quality and image-size setting. With the image-size setting of 1600 X 1200, the maximum rate of capture is 2 fps. If the image quality is set to super fine (p. 36) only one frame can be captured at a time.

Continuous advance is selected in the basic section of the recording-mode menu (p. 28).

Compose the picture as described in the basic recording operation section (p. 23). Press the shutter-release button partway down to lock the exposure and focus for the series. Press and hold the shutter-release button all the way down (1) to begin taking pictures. When the shutter-release button is pressed and held, the camera will begin recording images until the maximum number has been taken or the shutter button is released. The built-in flash can be used, but the rate of capture is reduced because the flash must recharge between frames. The frame counter is adjusted after the series has been taken while the images are being saved.

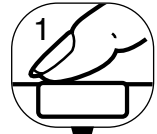

The chart lists the maximum number of images that can be captured with different image-quality and image-size combinations.

Image Quality \ Image Size	1600 X 1200	1280 X 960	640 X 480
Fine	7	11	44
Standard	15	23	81
Economy	29	44	140

Self-timer



Used for self-portraits, the self-timer will delay the release of the shutter for approximately ten seconds after the shutter-release button is pressed. The self-timer drive mode is selected in the basic section of the recording-mode menu (p. 28).

With the camera on a tripod, compose the picture as described in the basic recording operation section (p. 23). Focus lock (p.24) can be used with off-center subjects. Press the shutter-release button partway down to lock the exposure and focus (1). Press the shutter-release button all the way down to begin the countdown (2). Because focus and exposure are determined when the shutter-release button is pressed, do not stand in front of the camera when taking a self-timer image. Always confirm the focus with the focus signals before beginning the countdown (p. 25).

During the countdown, the self-timer lamp on the front of the camera (3) will start to blink. A few seconds before the exposure, the self-timer lamp will blink rapidly. The lamp will glow steadily just before the shutter fires. To stop the countdown, press the zoom lever. To stop the countdown and cancel the self-timer, press the main switch. The drive mode will be reset to single-frame advance after the exposure.

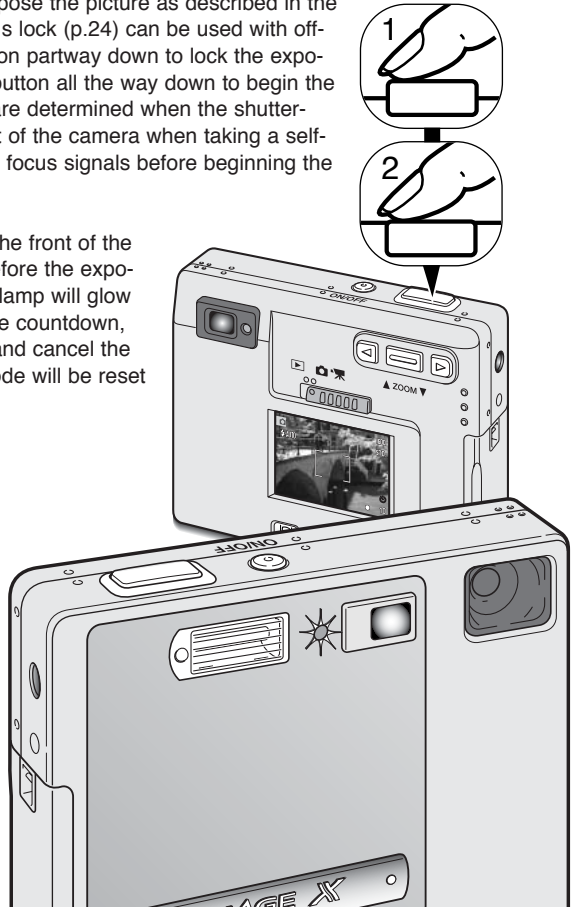

Movie recording



The movie-recording drive mode is selected in the basic section of the recording-mode menu (p. 28). Movie clips up to approximately thirty-five seconds in length with audio can be recorded. The movie image is 320 X 240 pixels (QVGA) and recorded at a rate of around 340KB/s. Approximately one 19-second movie clip can be stored on one 8MB memory card.

Shooting digital video is simple. Frame the picture on the LCD monitor. Press and release the shutter-release button to begin recording (1); "Rec" will be displayed during recording. The camera will continue to record until the recording time is used or the shutter-release button is pressed again.

When recording, the frame counter will countdown the recording time. Take care not to cover the microphone while recording. During recording, focus is locked and the optical zoom is disabled. However, a stepless 2X digital zoom can be used with the zoom lever.

After recording, a screen will appear indicating the movie clip is being saved to the memory card. Never remove the memory card or disconnect the power supply while the clip is being saved.

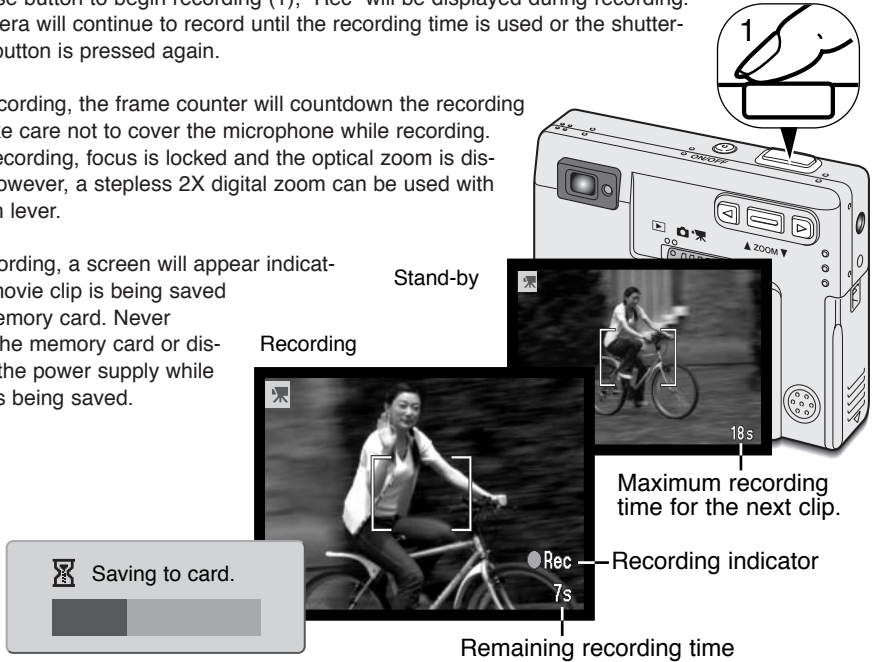

Audio recording



Ninety seconds of audio can be recorded without an image. The audio-recording drive mode is selected in the basic section of the recording-mode menu (p. 28). When the function is active, the live view is replaced with a blue screen.

Approximately 842 seconds of audio can be stored on one 8MB memory card. Audio is recorded at approximately 8KB/s

To begin recording, press the shutter-release button (1). A bar graph (2) will display the amount of recorded time. The recording will stop when the shutter-release button is pressed again or the ninety-second limit has elapsed.

When making audio recordings, be careful not to touch or cover the microphone. The quality of the recording is proportional to the subject to microphone distance. For best results, hold the camera approximately 20cm (8in) from your mouth.

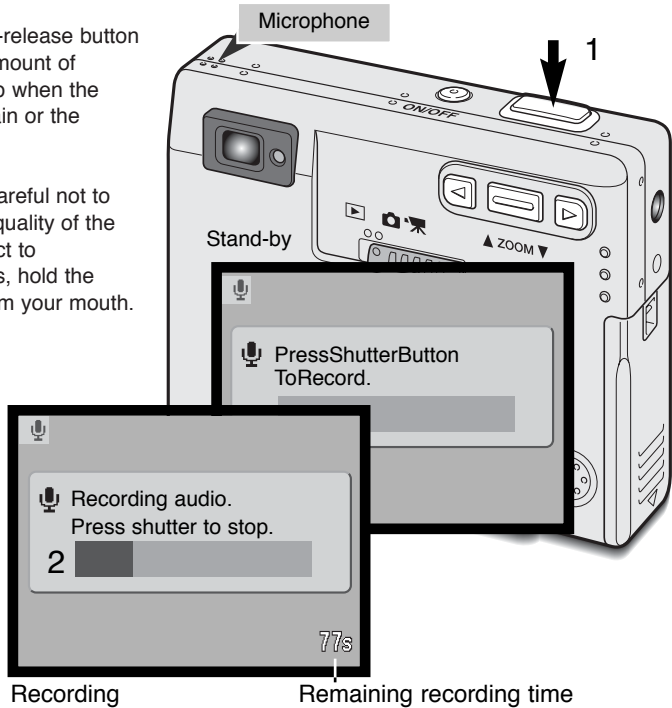

Image size



Changing image size affects the number of pixels in each image. The greater the image size, the larger the file size. Choose image size based on the final use of the image - smaller images will be more suitable for web sites whereas larger sizes will produce higher quality prints. Image size must be set before the picture is taken. Image size is set in the basic section of the recording-mode menu (p. 28).

Three image sizes are available: 1600 X 1200 (UXGA), 1280 X 960 (SXGA), and 640 X 480 (VGA). Image size is defined by the image's horizontal and vertical dimensions in pixels. The selected image-size setting is displayed on the LCD monitor by the horizontal dimension only.

If the image size is changed, the frame counter will display the approximate number of images that can be recorded at that setting on the installed memory card. One memory card can contain images with differing sizes.

Image quality

This camera has four image-quality settings: super fine, fine, standard, and economy. Always select the desired setting before taking the picture. Image quality is set in the basic section of the recording-mode menu (p. 28).

Image quality controls the rate of compression, but has no effect on the number of pixels in the image. The higher the image quality, the lower the rate of compression and the larger the file sizes. If the economical use of the memory card is important, use the economy mode. Standard image quality is sufficient for normal usage. The super-fine mode will produce the highest quality image and the largest image files.

File formats vary with the image quality setting. Super fine images are saved as a TIFF file. Fine, standard, and economy images are formatted as JPEG files.

If the image quality is changed, the LCD monitor will display the approximate number of images that can be recorded at that setting on the installed memory card. One memory card can contain images with differing qualities.

LCD monitor display		File type
S. FIN	Super fine - the highest-quality image.	TIFF
FINE	Fine - high-quality image.	JPEG
STD	Standard - the default setting.	JPEG
ECON	Economy - the smallest file sizes.	JPEG

The frame counter and memory card capacity

The number of images that can be stored on a memory card is determined by the size and type of card and the file size of the images. The actual file size is determined by the scene; some subjects can be compressed further than others.

		Approximate file sizes.		
		1600 X 1200	1280 X 960	640 X 480
Image quality	Image size			
	Super fine	5.5MB	3.5MB	0.89MB
	Fine	0.93MB	0.60MB	0.17MB
	Standard	0.47MB	0.31MB	0.09MB
Economy	0.24MB	0.17MB	0.05MB	
Approximate card capacity for an 8MB memory card.				
Super fine	1 image	1 image	7 images	
Fine	6 images	10 images	39 images	
Standard	13 images	20 images	68 images	
Economy	25 images	39 images	117 images	

The frame counter indicates the approximate number of images that can be stored on the memory card at the camera's image quality and size settings. If the settings

are changed, the frame counter adjusts accordingly. Because the calculation is based on approximate file sizes, the actual image taken may not change the counter or may decrease it by more than one.

When the frame counter displays three red zeros, it indicates no more images at the image size and quality settings can be captured. Changing the image size or quality settings may allow more images to be captured.

White balance

White balance is the camera's ability to make different types of lighting appear neutral. The effect is similar to selecting daylight or tungsten film, or using color compensating filters in conventional photography.

One automatic and four preset white-balance setting are available. When one of the preset white-balance settings is selected, an icon will be displayed on the LCD monitor to indicate the active white-balance setting. White balance is set in the basic section of the recording-mode menu (p. 28).

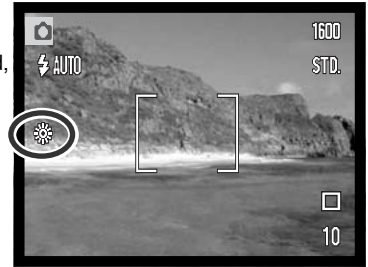

Automatic white balance

The automatic white balance compensates for the color temperature of a scene. In most cases, the auto setting will balance the ambient light and create beautiful images, even under mixed-lighting conditions. When the built-in flash is used, the white balance is set for the color temperature of the flash.

SHOOTING TIPS

White balance cannot correct high-energy vapor lighting: sodium-vapor (yellow highway lights), or mercury vapor. For portraits under these lighting conditions, the flash can be used to overpower the ambient light if the subject is within range. With landscapes containing these types of lights, set the white balance to the preset daylight setting.

Preset white balance

Preset white-balance settings must be set before the image is taken. Once set, the effect is immediately visible on the monitor.

To record the ambient light, set the flash mode to flash cancel (p. 26). The built-in flash can be used with preset white-balance, but will create a pinkish or blueish cast with the fluorescent and tungsten settings. The flash is daylight balanced and will produce good results with the daylight and cloudy settings.



Daylight - for outdoor and sunlit subjects.



Cloudy - for overcast outdoor scenes.



Tungsten - for incandescent lighting: household filament light bulbs.



Fluorescent - for fluorescent lighting: office ceiling lights.

Digital zoom

Assisting the optical zoom is a four-step 2X digital zoom. The digital zoom is activated in the custom section of the recording-mode menu (p. 28).

The digital zoom increases the magnification of the greatest telephoto setting of the optical zoom in four steps: X1.25, X1.50, X1.75, and X2.00. Although the images recorded with the digital zoom are interpolated to the set image size, the quality of the images may not be equal to images taken without the digital zoom. The effect of the digital zoom is visible on the LCD monitor only. The digital-zoom function is canceled if the LCD monitor is turned off (p. 48).

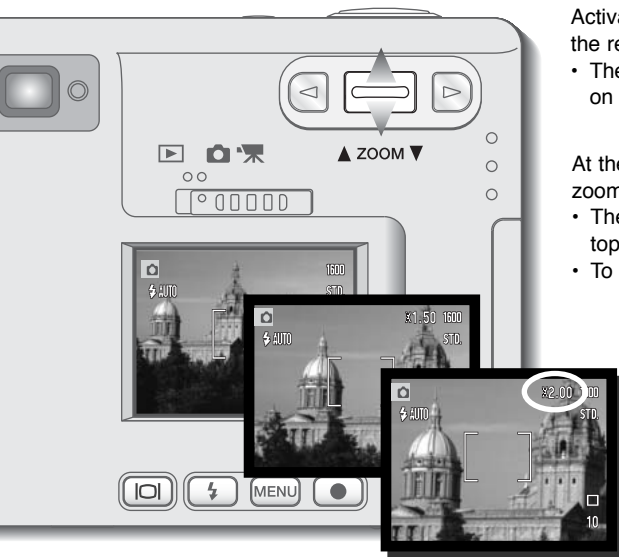

Activate the digital zoom in the custom section of the recording mode menu.

- The digital zoom will remain active until reset on the menu.

At the maximum telephoto position, press the zoom lever up to engage the digital zoom.

- The zoom magnification will be displayed in the top right corner of the monitor.
- To zoom out, press the zoom lever down.

Instant playback

After a still image is captured, it can be displayed on the monitor for two seconds before being saved. Instant playback shows the last frame in the series when used with the continuous-advance drive mode (p. 31). When the LCD monitor is turned off (p. 48), it will automatically activate for the instant playback period.

Instant playback can be activated in the custom section of the recording-mode menu (p. 28). When used with voice memo, the audio recording will begin after the image is played back.



MINOLTA HISTORY



Innovation and creativity has always been a driving force behind Minolta products. The Electro-zoom X was purely an exercise in camera design. It was unveiled at Photokina in Germany in 1966.

The Electro-zoom X was an electronically controlled aperture-priority mechanical SLR with a built-in 30 - 120mm f/3.5 zoom lens giving twenty 12 X 17mm images on a roll of 16mm film. The shutter-release button and battery chamber are located in the grip. Only a few prototypes were built making it one of Minolta's rarest cameras.

Voice memo



Voice memo allows an audio track up to fifteen seconds to be recorded with a still image. The function is activated in the custom section of the recording-mode menu (p. 28). When the function is active, the white microphone icon is displayed on the LCD monitor. The voice memo must be set before taking a picture. It will remain in effect until reset. When the LCD monitor is turned off (p. 48), it will automatically activate for the voice-memo period.

After an image is captured, a screen will appear indicating the audio recording has started. A bar graph (1) will display the amount of recording time remaining. To stop the recording, press the shutter-release button or enter button (2). The recording will automatically stop when the fifteen-second limit has elapsed.

Voice memo is attached to the last image of a continuous-advance series (p. 31). When played back, images with voice-memo audio tracks have a note icon displayed with them (p. 51).

When making audio recordings, be careful not to touch or cover the microphone. The quality of the recording is proportional to the subject to microphone distance. For best results, hold the camera approximately 20cm (8in) from your mouth.



Folder name

All recorded images are stored in folders on the memory card. Folder names come in two formats: standard and date.

Standard folders have an eight character name. The initial folder is named 100MLT09. The first three digits are the folder's serial number, which will increase by one each time a new folder is created. The next three letters refer to Minolta, and the last two numbers indicate the camera used; 09 indicates a DiMAGE X.

A date folder name also starts with the three digit serial number and is followed by one register for the year, two registers for the month, and two registers for the day: 100YMMDD. The folder 10120412 was created in 2002 on April 12th.

With the date folder format selected, when an image is recorded a new folder with the day's date will be created. All images recorded that day will be placed in that folder. Images recorded on a different day will be placed in a new folder with the corresponding date. When a new folder is created, the serial number in the image-file name is reset to 0001. For more information on folder organization and file names, see page 72.



100MLT09
(Standard)



10120412
(Date)

LCD brightness

The brightness of the LCD monitor can be set in eleven levels. After selecting the LCD brightness option and pressing the enter button on the menu (p. 28, 54), the LCD brightness screen will be displayed. Pressing and holding the display button will also activate the LCD brightness screen.

Use the left and right keys (1) to adjust the brightness level; the monitor image will change accordingly. To set the level, press the enter button (2); the camera will return to the recording or playback mode. The LCD brightness level will affect both modes.



Auto-power-off menu settings

To conserve battery power, the camera will shut down if an operation is not made within a certain period. To restore power, press the main switch. The length of the auto-power-off period can be changed in the setup 1 section of the recording and playback-mode menu (p. 28, 54): 1, 3, 5, 10, and 30 minutes. The length of the auto-power-off period is fixed at 10 minutes when the camera is connected to a computer.

Audio signals

The camera's audio signals can be turned off and on in the setup 1 section of the recording and playback-mode menu (p. 28, 54).

Setting the date and time

It is important to accurately set the clock. When a recording is made, the date and time of the recording are saved with the file and are displayed in playback mode or with the DiMAGE Image Viewer Utility software included on the CD-ROM. The date and time are set in the setup 1 section of the recording and playback-mode menu (p. 28, 54).

When the Date/Time-set option is selected and entered, the date/time screen will be displayed. The left and right keys (1) are used to select the item to be changed and the zoom lever (2) is used to change the value. From left to right, the screen shows the year, month, day, hour, and minute. When the date and time have been adjusted, set the clock by pressing the enter button (3). The menu button cancels the screen without applying any changes.

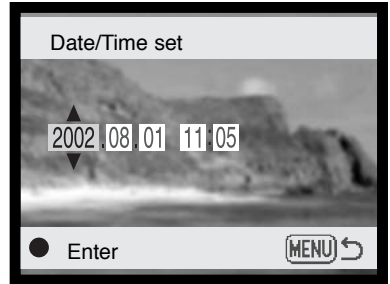

Setting the date format

The date format that is displayed can be changed: YYYY/MM/DD (year, month, day), MM/DD/YYYY (month, day, year), DD/MM/YYYY (day, month, year). Simply select the format and enter it by pressing the enter button; the new format will be displayed on the menu. The date format does not affect date folder names (p. 43). The date format is set in the setup 1 section of the recording and playback-mode menu (p. 28, 54).

Exposure compensation



The camera exposure can be adjusted to make the final picture lighter or darker by as much as $\pm 2\text{Ev}$ in $1/3$ increments. The exposure-compensation value will remain in effect until it has been reset or the camera has been turned off.

The exposure compensation must be set before the image is captured. When setting the exposure compensation, the amount of compensation is shown next to the exposure-compensation icon on the monitor. When set to any value other than 0.0, the icon will remain on the LCD monitor as a warning. To set the exposure compensation, the monitor must be on.

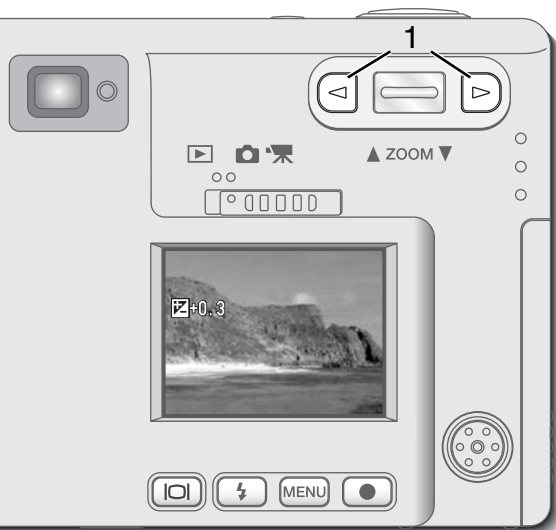

Use the left and right keys (1) to adjust the exposure-compensation value.

- The LCD monitor will display the exposure-compensation icon and value.
- Change in exposure compensation is visible in the live image on the monitor.

The adjustment in exposure will be automatically set after five seconds or when another camera button is pressed.

Sometimes the camera's exposure meter is deceived by certain subjects. Exposure compensation can be used in these situations. For example, a very bright scene, such as a snowy landscape or a white sandy beach, can appear too dark in the captured image. Before taking the picture, adjusting the exposure by +1 or +2 Ev will result in an image with normal tonal values.

In this example, the dark scene appears bright and washed-out on the LCD monitor. By decreasing the exposure by -1.5 Ev, the richness of the sunset is preserved.

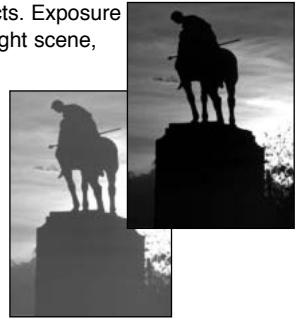

What is an Ev?

Ev stands for exposure value. A change of one Ev will adjust the exposure calculated by the camera by a factor of two.

Change in Ev	Adjustment to exposure
+2.0 Ev	4X as much light
+1.0 Ev	2X as much light
0.0 Ev	Calculated exposure
-1.0 Ev	1/2 as much light
-2.0 Ev	1/4 as much light

Display button - recording mode

The display-information button controls the LCD monitor display. The display cycles to the next position each time the button is pressed: full display, live image only, and monitor off. If the display button is pressed and held, the LCD-brightness adjustment screen will appear, see page 44.

Battery power can be conserved by turning the monitor off and using the viewfinder to take pictures. However, because of parallax, the monitor should be used for subjects closer than 1m (3ft.) at the zoom lens' wide-angle position or 3m (10ft) at the telephoto position. When the flash-mode or menu button is pressed, the monitor will automatically turn on. The digital zoom is disabled when the monitor is off. The monitor cannot be turned off in audio or movie recording. When the LCD monitor is off, it will automatically activate for the instant playback period.

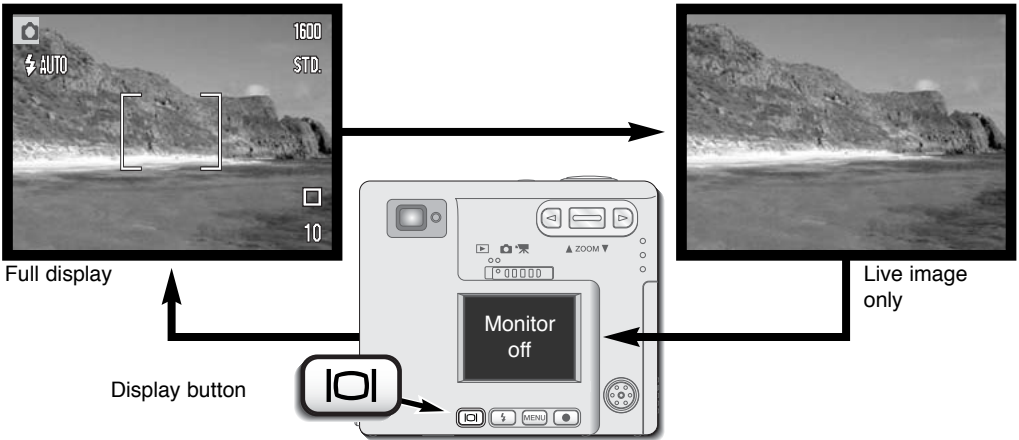

A short guide to photography

Photography can be a rewarding pursuit. This guide is an introduction to some basic photographic principles.

The zoom lens does not only affect how large the subject is in the picture, but it also influences the depth of field and perspective. Depth of field is the area between the closest object in focus and the furthest object in focus. As the lens zooms in (telephoto position) to the subject, the depth of field becomes shallower, separating the subject from the background. Many portraits are taken with telephoto lenses. Zooming the lens out to the wide-angle position makes both the foreground and background appear sharper. Usually landscape photographs take advantage of the large depth of field of wide-angle lenses.



Wide-angle lenses also create a strong perspective which gives a sense of depth in the image. Telephoto lenses compress the space between the subject and background and create a weak perspective.

PLAYBACK MODE

This section details how to view and edit images on the camera. Basic operation of the playback mode is covered from page 50 to 56. Detailed descriptions of the playback menu settings follow the menu navigation section.

Single-frame playback display

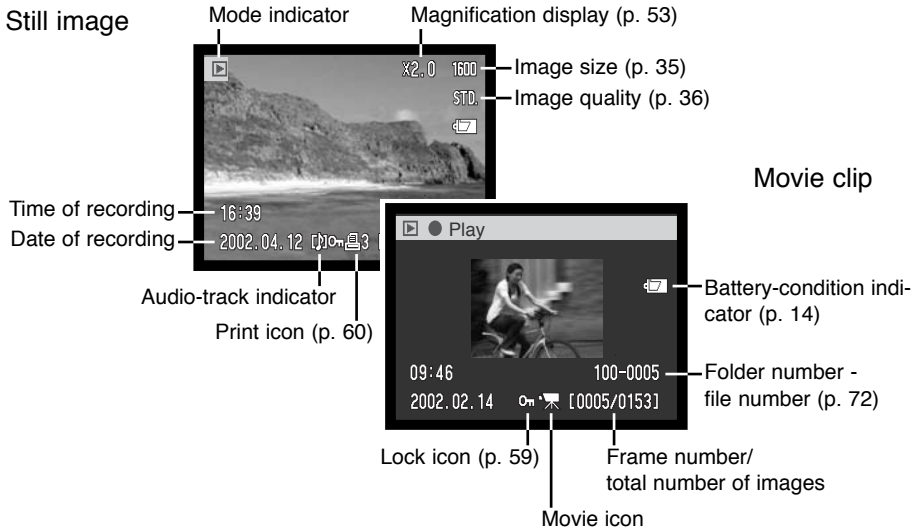

An audio recording (p. 34) has no image data and so the LCD monitor will show a blue screen to indicate the audio file. The time and date of recording, lock status, frame number, and folder and file number are displayed.

Viewing images and playing back audio recordings

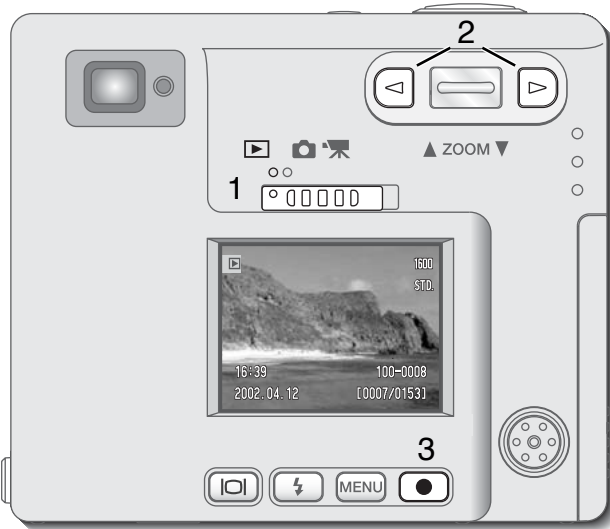

Playing back still images, movie clips, and audio recordings is simple. Slide the mode switch to the playback position (1) and use the left and right keys to scroll through the recordings on the memory card (2).



A note icon at the bottom of the monitor indicates the image has an audio track.

To play back the audio track, press the enter button (3).

- To cancel a voice memo or audio caption, press the menu button.
- To pause and restart an audio recording, press the enter button. Pressing the menu button cancels the playback.



A movie-camera icon at the bottom of the monitor indicates a movie clip.

To play back the movie clip, press the enter button (3).

- To pause and restart the movie playback, press the enter button. Pressing the menu button cancels the playback.

Display button - playback mode

The display button controls the display format. Each time the button is pressed, the display cycles through to the next format: full display, image only, index playback.

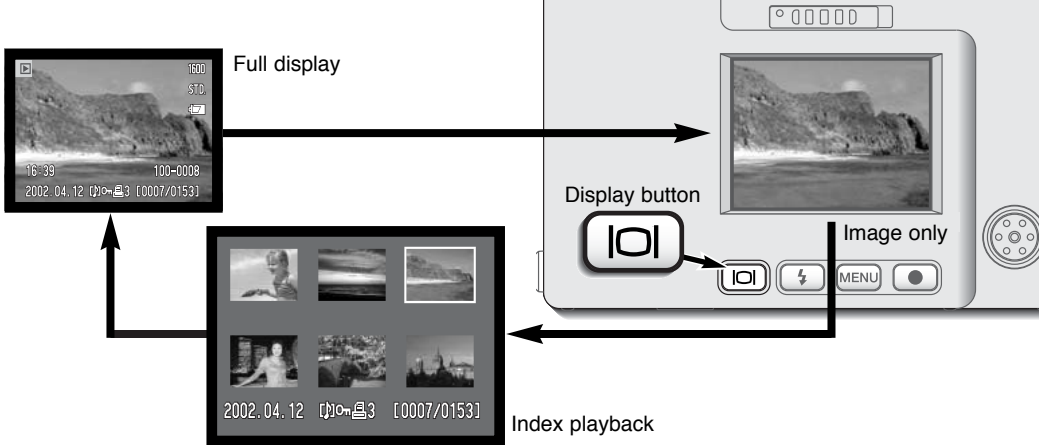

In index playback, the left and right keys, and zoom lever moves the yellow border around the index thumbnails. When the image is highlighted with the border, the date of recording, audio-track indicator, the lock and printing status, and the frame number of the image are displayed at the bottom of the screen. The accompanying audio track of the highlighted image can be played by pressing the enter button. When the display information button is pressed again, the highlighted image will be displayed in the single-frame playback mode.

Enlarged playback

In single-frame playback, a still image can be enlarged in six steps for closer examination: 1.5X, 2.0X, 2.5X, 3.0X, 3.5X, and 4.0X.



With the image to be magnified displayed, press the zoom lever up to activate the enlarged playback mode.

- The degree of magnification is displayed on the LCD monitor.



Pressing the zoom lever up increases the image magnification. Pressing the zoom lever down decreases the image magnification.



- The display button switches between showing the full display and image only.



To scroll the image, press the enter button.

- Pressing the enter button switches between the enlarged-playback and scroll screens.



Use the left and right keys, and the zoom lever to scroll the image.



- To exit the enlarged playback mode, press the menu button.

Navigating the playback-mode menu

In playback mode, simply press the menu button to activate the menu. The menu is used to edit images and control camera operations.



Activate the playback-mode menu with the menu button.



The “Basic” tab at the top of the menu will be highlighted. Use the left/right keys to highlight the appropriate menu tab; the menus will change as the tabs are highlighted.



When the desired menu section is displayed, use the zoom lever to scroll through the menu options. Highlight the option whose setting needs to be changed.



With the menu option to be changed highlighted, press the right key; the settings will be displayed with the current setting indicated by an arrow.

- To return to the menu options, press the left key.



Use the zoom lever to highlight the new setting.

- If “Enter” is displayed, press the enter button to display the setting screen.

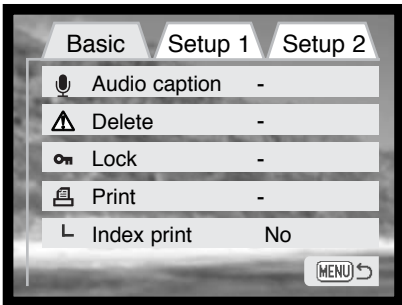

Press the enter button to select the highlighted setting.

Once a setting has been selected, the cursor will return to the menu options and the new setting will be displayed. Changes can continue to be made. To return to the playback mode, press the menu button.

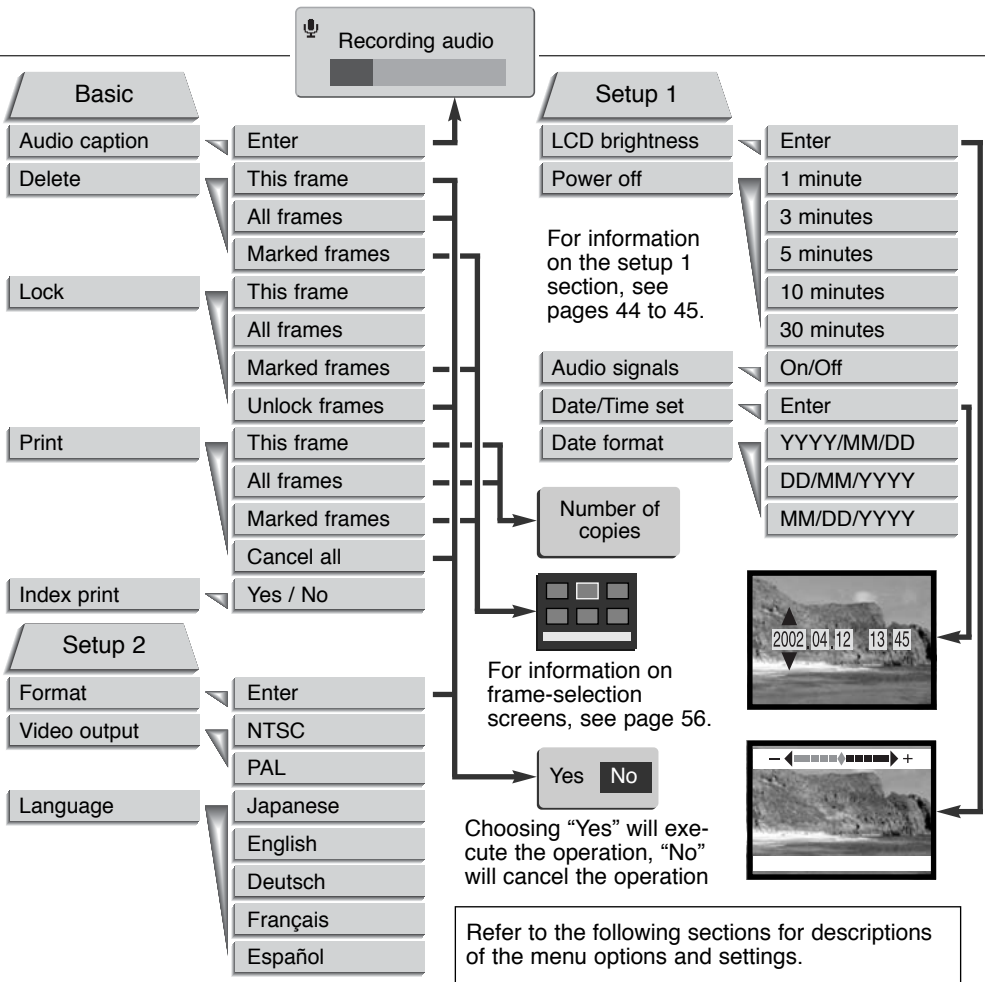

Frame-selection screen

When a marked-frames setting is chosen on the menu, the frame selection screen will appear. This screen allows multiple image and audio files to be chosen.



The left and right keys move the yellow border to select the frame.



The menu button cancels the screen and any operation made.



Pressing the zoom lever up selects the frame; when selected, an icon will appear next to the frame. Pressing the zoom lever down deselects the frame removing the icon.



The garbage-can icon indicates the frame is selected for deletion.



The key icon indicates the image or audio file is locked or selected to be locked.



The printer icon indicates the image is selected for printing. The number next to the icon shows if two or more copies are requested.

Audio captioning

A still image can have a fifteen-second audio caption attached to it. This function will also replace a voice-memo audio track recorded with an image. Audio captions cannot be attached to movie clips, nor can they over rewrite audio recordings.



Display the image to which the audio caption will be attached. If the image is locked, unlock it using the basic section of the playback menu (p. 54).

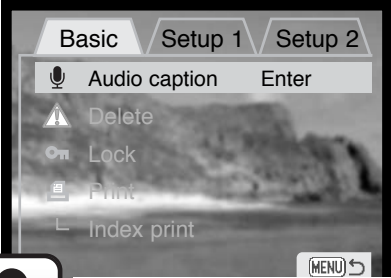

On the playback menu, highlight the “Enter” setting in the audio-caption option.

- Press the enter button (1) to start recording.
- If an audio track is already attached to the image file, a confirmation screen will appear. Choosing and entering “Yes” will start the audio caption recording replacing the previous audio track. “No” will cancel the audio-caption operation.



1

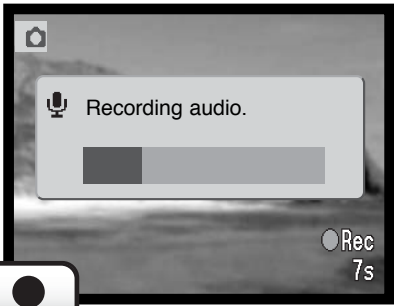

The audio caption can be stopped during the fifteen-second recording period by pressing the enter button (1).

Deleting image and audio files

Deleting permanently erases the image or audio file. Once deleted, a file cannot be recovered. Care should be taken when deleting files.



Single, multiple, or all image or audio files on the memory card can be deleted with the playback-mode menu. Before a file is deleted, a confirmation screen will appear; choosing “Yes” will execute the operation, “No” will cancel the operation.

The delete option has three settings:

This frame - The image or recording displayed or highlighted in playback mode will be deleted.

All frames - All unlocked files on the memory card will be deleted.

Marked frames - To delete multiple image or audio files. When this setting is chosen, the frame-selection screen will be displayed. Use the left and right keys to highlight the first file to be deleted. Pressing the zoom lever up will mark the frame with the garbage-can icon. To deselect a file for deletion, highlight it with the yellow border and press the zoom lever down; the garbage-can icon will disappear. Continue until all the files to be deleted are marked. Press the enter button to continue (a confirmation screen will appear), or press the menu button to cancel the operation and return to the playback menu. On the confirmation screen, highlighting and entering “Yes” will delete the marked files.

The delete function will only erase unlocked image or audio files. If a file is locked, it must be unlocked before it can be deleted. If an image file has a voice memo or audio caption attached, both the image and audio file will be deleted.

Locking image and audio files



Single, multiple, or all image or audio files on the memory card can be locked. A locked file cannot be erased by a playback menu delete function. Important images should be locked.

The lock option has four settings:

This frame - The frame displayed or highlighted in playback mode will be locked. If the this-frame option is used with a locked image, the image will be unlocked.

All frames - All image and audio files on the memory card will be locked.

Marked frames - To lock or unlock multiple files. When this setting is chosen, the frame-selection screen will be displayed. Use the left and right keys to highlight the image or audio recording to be locked. Pressing the zoom lever up will mark the frame with the key icon. To unlock a file, highlight it with the yellow border and press the zoom lever down; the key icon will disappear. Continue until all the files to be locked are marked. Press the enter button to lock the marked frames, or press the menu button to cancel the operation and return to the playback menu.

Unlock frames - All files in the folder will be unlocked. When selected, a confirmation screen will appear; highlighting and entering "Yes" will unlock all files on the card.

Locking an image will protect it from a delete function. However, the formatting function (p. 62) will erase all data on a memory card whether locked or not.

About DPOF

This camera is supported by DPOF version 1.1. DPOF (Digital Print Order Format) allows direct printing of still images from digital cameras. After the DPOF file is created, the memory card is simply taken to a photofinishing service or inserted into the card slot of DPOF compatible printers. When a DPOF file is created, a misc. folder is automatically made on the memory card to store it (p. 72).

Creating a DPOF print order



The print menu option is used to set an order for standard prints from still images on the memory card. Single, multiple, or all images can be printed.

The print option has four settings:

This-frame - To create a DPOF file for the image displayed or highlighted in playback mode.

All-frames - To create a DPOF file for all still images on the memory card

Marked frames - To chose a group of images to be printed or when the number of copies for each image varies. When selected, the frame selection screen will appear. Use the left and right keys to highlight an image to be printed. Pressing the zoom lever up will mark the image with the printer icon. The number next to the icon indicates the number of copies of that image will be printed. Pressing the zoom lever up will increase the number of copies, pressing the zoom lever down will decrease the number. A maximum of nine copies can be ordered. To deselect an image for printing, press the zoom lever down until the the number of copies reaches zero and the printer icon disappears. Continue until all the images to be printed are marked. Press the enter button to create the DPOF file, or press the menu button to cancel the operation and return to the playback menu.

Cancel all - To delete the DPOF print files. When selected, a confirmation screen will appear; highlighting and entering "Yes" will cancel the print order.

When the this-frame or all-frames setting is chosen, a screen will appear requesting the number of copies of each image; a maximum of nine copies can be ordered. Use the zoom lever to set the number of copies desired. If the all-frames setting was used to create a print order, any additional images saved afterwards on the memory card will not be included in the order. The print icon is displayed with selected images in playback mode. If more than one copy of the image is ordered, the number of copies will be displayed next to the icon.

After the pictures have been printed, the DPOF file will still remain on the memory card. The DPOF files must be canceled manually. DPOF files cannot be created for images captured with another camera. DPOF data created on other cameras will not be recognized.

Ordering an index print

To create an index print of all the images on the memory card, select "Yes." To cancel an index-print order, simply change the setting to "No."

If an index-print order is created, any additional images saved afterwards on the card will not be included in the index print. The number of images printed per sheet differs between printers. The information printed with the thumbnails can vary.



Formatting memory cards

When a memory card is formatted, all data on the card is erased.

The formatting function is used to erase all data on a memory card. Before formatting a card, copy the data to a computer or storage device. Locking images will not protect them from being deleted when the card is formatted. Always format the memory card using the camera; never use a computer to format a card.

When the format option is selected and entered, a confirmation screen will appear. Choosing "Yes" will format the card, choosing "No" will cancel the formatting operation. A screen will appear to indicate the card has been formatted.

If the unable-to-use-card message appears, the inserted card in the camera may need to be formatted. A memory card used in another camera may have to be formatted before being used.

Video output

Camera images can be displayed on a television (p. 63). The video output can be changed between NTSC and PAL. North America uses the NTSC standard and Europe uses the PAL standard. Check which standard is used in your region to play back images on your television set.

Language

The menu language can be changed.

Viewing images on a television

It is possible to view camera images on your television. The camera has a AV-out terminal to make the connection using the supplied AV cable. The camera is compatible with the NTSC and PAL standards. The video-output setting can be checked and set in the setup 2 section of the playback menu (p. 54).

1. Turn off the television and the camera.
2. Insert the AV cable into the camera's AV-out / USB terminal.
3. Plug the other end of the AV cable into the video and audio input terminals on the television.
 - The yellow plug is for the video output. The white plug is for the monaural audio output.
4. Turn the television on.
5. Set the television to the video channel.
6. Turn the camera on and slide the mode switch to the playback position.
 - The camera's monitors will not activate when the camera is attached to a television. The playback-mode display will be visible on the television screen.
7. View images as described in the playback section.

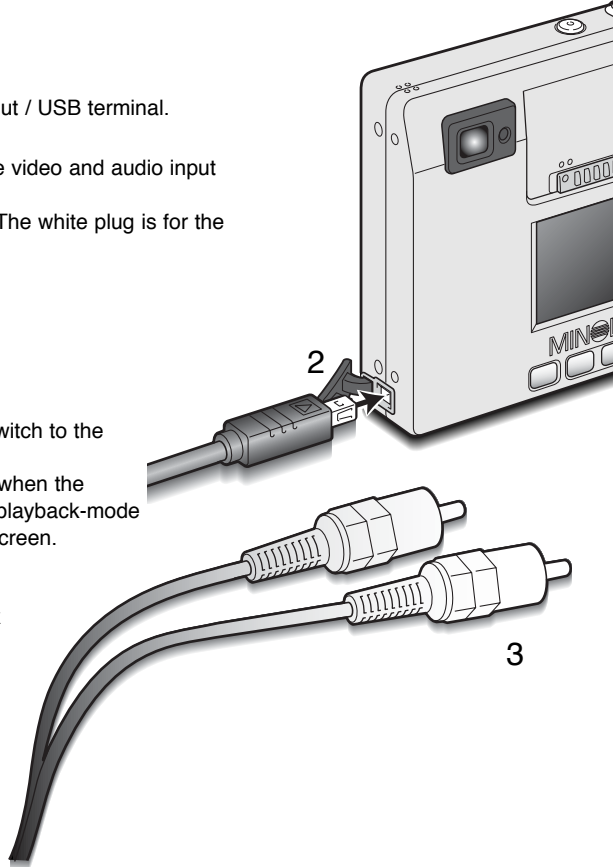

DATA-TRANSFER MODE

Read this section carefully before connecting the camera to a computer. Details on using and installing the DiMAGE Image Viewer Utility software are found in the supplied software manual. The DiMAGE manuals do not cover the basic operation of computers or their operating systems; please refer to the manual supplied with your computer.

DiMAGE X system requirements

For the camera to be connected directly to the computer and used as a mass-storage device, the computer must be equipped with a USB port as a standard interface. The computer and the operating system must be guaranteed by their manufacturers to support USB interface. The following operating systems are compatible with the camera:

IBM PC / AT Compatible	Macintosh
Windows 98, 98SE, Me, 2000 Professional, and XP.	Mac OS 8.6 ~ 9.2.1 and Mac OS X 10.1

Users with Windows 98 or 98 second edition will need to install the driver software on the included DiMAGE software CD-ROM (p. 67). Users with Mac OS 8.6 will need to download and install a USB mass-storage device from the Apple web site (p. 70).

Customers who have bought a DiMAGE 7, 5, S304, or 2330 digital camera and have installed the Windows 98 driver software must repeat the installation procedure. The updated version of the driver software included on the supplied DiMAGE software CD-ROM is required for the operation of the DiMAGE X with a computer. The new software will have no affect on the performance of the DiMAGE 7, 5, S304, or 2330.

Connecting the camera to a computer

A fully charged battery should be used when the camera is connected to a computer. The use of the AC adapter (sold separately) is recommended over the use of the battery. For users with Windows 98, 98SE, or Mac OS 8.6, read the respective sections on how to install the necessary USB driver before connecting the camera to a computer (Windows 98 - p. 67, OS 8.6 - p. 70).

- 1 Start up the computer.
 - The computer must be turned on before connecting the camera.
- 2 Insert the memory card into the camera.
 - Confirm that the correct card is in the camera. To change the memory card while the camera is connected to a computer, see page 71.
- 3 Remove the USB-port cover. Attach the smaller plug of the USB cable to the camera.
 - Make sure the plug is firmly attached.
 - The USB-port cover is attached to the body to prevent loss.

- 4 Attach the other end of the USB cable to the computer's USB port.
 - Make sure the plug is firmly attached.
 - The camera should be connected directly to the computer's USB port. Attaching the camera to a USB hub may prevent the camera from operating properly.

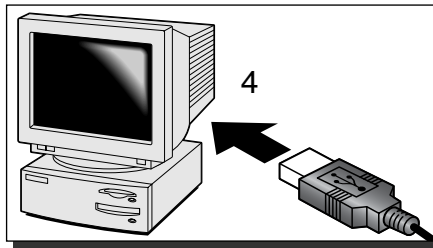

3

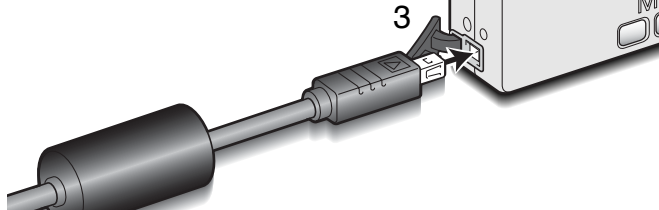

(Continued on the next page)

DATA-TRANSFER MODE

- 5 Turn on the camera to initiate the USB connection.
- While the camera is connected to a computer, the data-transfer screen will be displayed.

When the camera is properly connected, a drive icon will appear on the computer. When using Windows XP, the removable-disk window will be displayed.

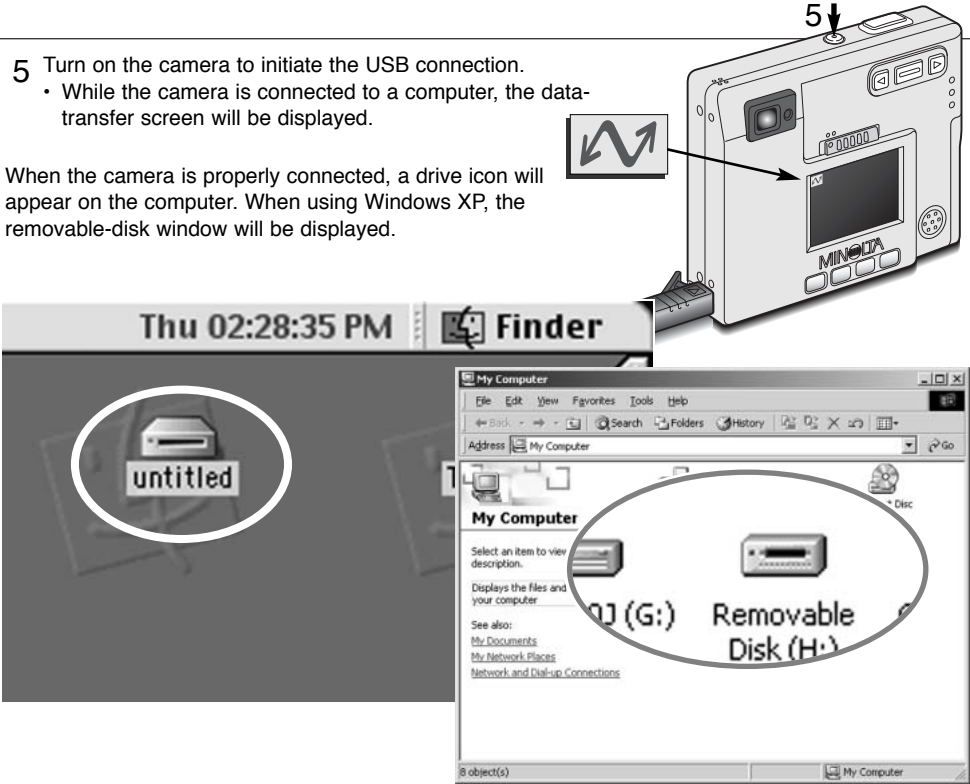

If the computer does not recognize the camera, disconnect the camera and restart the computer. Repeat the connection procedure above. For users with Windows operating systems, the driver software can be uninstalled in the event of an error during installation. See page 81 for instructions.

Connecting to Windows 98 and 98SE

The driver needs only to be installed once. If the driver cannot be installed automatically, it can be installed manually with the operating system's add-new-hardware wizard; see the instructions on the following page. During installation, if the operating system requests the Windows 98 CD-ROM, insert it into the CD-ROM drive and follow the accompanying instructions on the screen.

Automatic Installation



Before connecting the camera to the computer, place the DiIMAGE software CD-ROM in the CD-ROM drive. The DiIMAGE installer menu should automatically activate. To automatically install the Windows 98 USB driver, click on the starting-up-the-USB-device-driver-installer button. A window will appear to confirm that the driver should be installed; click "Yes" to continue.

When the driver has been successfully installed, a window will appear. Click "OK." Restart the computer before connecting the camera (p. 65).



Manual installation

To install the Windows 98 driver manually, follow the instructions in the connecting-the-camera-to-a-computer section on page 65.

When the camera is plugged into the computer, the operating system will detect the new device and the add-new-hardware-wizard window will open. Place the DiMAGE software CD-ROM in the CD-ROM drive. Click "Next."



Choose to specify the location of the driver. The browse window can be used to indicate the driver location. When the location is shown in the window, click "Next."

- The driver should be located in the CD-ROM drive at \Win98\USB.



Choose the recommended search for a suitable driver. Click "Next."





The add new hardware wizard will confirm the location of the driver. Click “Next” to install the driver in the system.

- One of three drivers may be located: MNLVENUM.inf, USBPDR.inf, or USBSTRG.inf.
- The letter designating the CD-ROM drive will vary between computers.

The last window will confirm the driver has been installed. Click “Finish” to close the add new hardware wizard. Restart the computer.



When the my-computer window is opened, a new removable-disk icon will be displayed. Double click on the icon to access the camera’s memory card; see page 72.

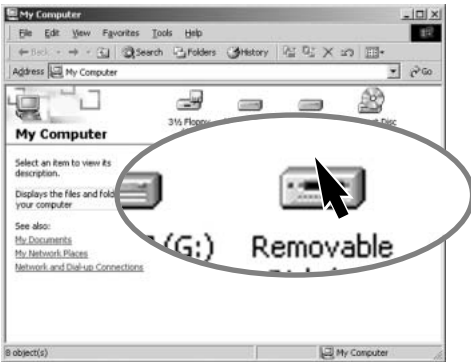

Connecting to Mac OS 8.6

To access this camera with a computer with Mac OS 8.6, the USB storage support 1.3.5.smi must be installed first. This software is supplied by Apple Computer, Inc. free of charge. It can be downloaded from the Apple web site at <http://www.apple.com>.

To download and install this software, follow the instruction on the Apple web site. Always read the attached terms and conditions before installing any new software.



USB Storage Support 1.3.5.smi

QuickTime system requirements

QuickTime 5.0 is used for viewing movie clips and playing audio files. To install QuickTime, follow the instructions in the installer. Macintosh users can download the latest version of QuickTime free of charge from the Apple Computer web site: <http://www.apple.com>.

IBM PC / AT Compatible

Pentium-based computer

Windows 95, 98, 98SE, NT, Me,
or 2000 Professional.

32MB or more of RAM

Sound Blaster or compatible sound card

DirectX 3.0 or later recommended

Auto power off - data-transfer mode

If the camera does not receive a read or write command within thirty minutes, it will shut down to save power. When the camera shuts down, an unsafe-removal-of-device warning may appear on the computer monitor. Click "OK." Neither the camera or computer will be damaged in this operation. Unplug the USB cable and turn off the camera. Remake the USB connection by reattaching the cable and turning the camera on.

Changing the memory card - data-transfer mode

Care should be taken when changing memory cards while the camera is attached to a computer. Data could be lost or damaged if the camera is not disconnected properly.

Windows 98 and 98SE

1. Disconnect the USB cable.
2. Turn off the camera.
3. Change the memory card.
4. Reconnect the USB cable.
5. Turn on the camera to remake the USB connection.

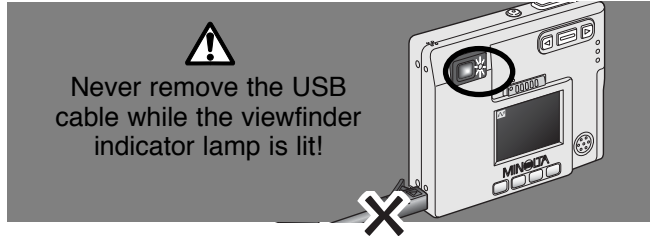

Windows Me, 2000 professional, and XP

1. Stop the USB connection using the unplug-or-eject-hardware routine (p. 74).
2. Disconnect the USB cable.
3. Turn off the camera.
4. Change the memory card.
5. Reconnect the USB cable.
6. Turn on the camera to remake the USB connection.

Macintosh

1. Stop the USB connection by dragging the drive icon into the trash (p. 75).
2. Disconnect the USB cable.
3. Turn off the camera.
4. Change the memory card.
5. Reconnect the USB cable.
6. Turn on the camera to remake the USB connection.

Memory card folder organization



Drive Icon

Once the camera is connected to the computer, image and audio files can be accessed by double clicking on icons. To copy images and audio recordings, simply drag and drop the file icon into a location in the computer.



Dcim



Misc

The misc. folder contains DPOF print files (p. 60).



100MLT09



10120801

Image-file names begin with "PICT" followed by a four-digit file number and a tif, jpg, mov, or thm extension. Voice-memo and audio caption files have a wav extension and the file name corresponds to its image file. Audio recordings also use the wav extension. The thumbnail images (thm) are produced with super-fine images and are only used in camera operation.



PICT0001.TIF



PICT0002.JPG

Fine, standard, or economy image



PICT0002.WAV

PICT0002's voice-memo or audio-caption file



PICT0003.MOV

Movie clip



PICT0004.WAV

Audio recording



PICT0001.THM
Super-fine image

Files and folders on the memory card can be deleted using the computer. Do not change the name of a file on the card or add a date to the card with a computer. Never format the memory card from the computer; always use the camera to format the card (p. 54, 62).

The number in the image file name may not correspond to the frame number of the image. As images are deleted on the camera, the frame counter will adjust itself to show the number of images in the folder and reassign the frame numbers accordingly. The file numbers will not change when an image is deleted. When a new image is recorded, it will be assigned a number one greater than the largest file number in the folder.

When the file number exceeds 9,999, a new folder will be created with a number one greater than the greatest folder number on the memory card: e.g. from 100MLT09 to 101MLT09. When a DPOF file is created for a print order (p. 60), a misc. folder is automatically made for the file.

CAMERA NOTES

Image files contain exif tag data. This data includes the time and date the image was recorded as well as the camera settings used. This data can be viewed with the camera or the DiIMAGE Image Viewer Utility software.

If an image is opened in a image-processing application that does not support exif tag data, and then the image is saved overwriting the original data, the exif tag information will be erased. When using software other than the DiIMAGE Image Viewer Utility, always rename the image file to protect the exif tag data.

Disconnecting the camera from a computer

The camera cannot be turned off until the USB cable is disconnected.

Windows 98 and 98SE

Confirm the indicator lamp is not lit. Disconnect the USB cable and then turn off the camera.

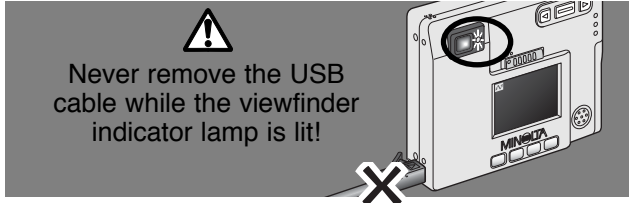

Windows Me, 2000 professional, and XP



To disconnect the camera, left click on the unplug-or-eject hardware icon located on the task bar. A small window will open indicating the device to be stopped.



Click on the small window to stop the device. The safe-to-remove-hardware window will appear. Close the window and then disconnect the USB cable and turn off the camera.



When more than one external device are connected to the computer, repeat the procedure above except right click on the unplug-or-eject hardware icon. This will open the unplug-or-eject hardware window after clicking on the small window indicating the device.

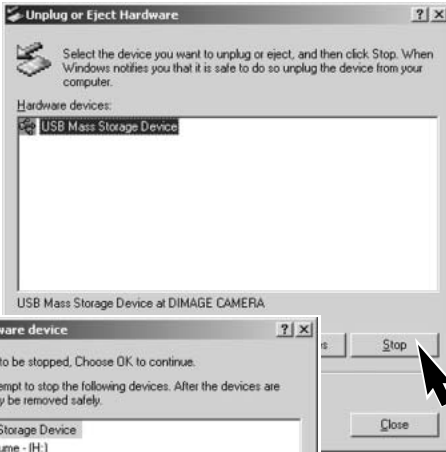

On the unplug-or-eject-hardware window, the hardware devices to be stopped will be displayed. Highlight the device by clicking on it then click "Stop."



A confirmation screen will appear to indicate the devices to be stopped. Clicking "OK" will stop the device.

The safe-to-remove-hardware screen will appear. Click "OK." Disconnect the USB cable and then turn off the camera.

Macintosh

Confirm the indicator lamp is not lit and then drag the mass-storage device icon and drop it into the trash.

Disconnect the USB cable and turn off the camera.

- If the USB cable is disconnected before performing the first step, an alert message will appear. Always complete the first step before disconnecting the USB cable.

Setting the menu language

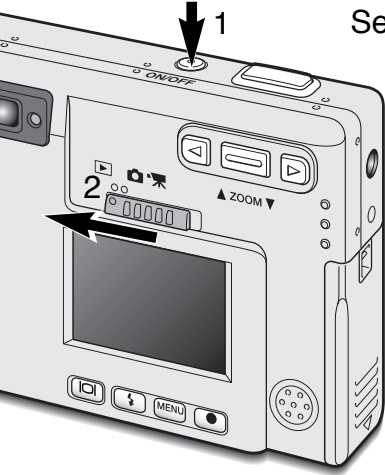



The menu language is set on the setup 2 section of the playback menu. Turn the camera on by pressing the main switch near the shutter-release button (1). Slide the mode switch to the playback position (2).

MENU Press the menu button to activate the playback menu.

 Use the right key to highlight the setup 2 tab at the top of the menu.

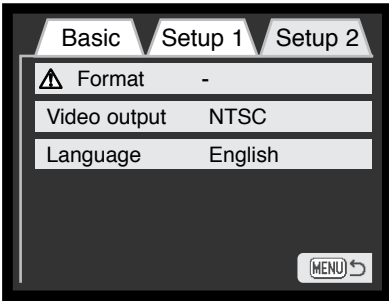
 Use the zoom lever to highlight the language menu option.



 Press the right key. The language settings will appear on the right side of the menu.

 Use the zoom lever to select the language.

 Press the enter button to set the selected language. The playback menu will be displayed.

MENU Press the menu button to close the playback menu.

Playback menu: setup 2 section

This section covers minor problems with basic camera operation. For major problems or damage, or if a problem continues to reoccur frequently, contact a Minolta service facility listed on the back cover of this manual.

Problem	Symptom	Cause	Solution
The camera will not work.	Nothing displayed on the the monitor.	The battery is dead.	Recharge the battery (p. 12).
		The auto-power-off function has shut down the camera.	Turn the camera on using the main switch.
		The AC adapter is not connected properly.	Check that the adapter is connected to the camera and a live electrical outlet (p. 15).
Shutter will not release.	"000" is displayed on the frame counter.	The memory card is full and unable to store an image at the image-quality or image-size setting on the camera.	Insert a new memory card (p. 16), delete some images (p. 54), or change the image-quality or image-size setting (p. 28).
	No-card warning appears on the monitor.	No memory card in the camera.	Insert a memory card (p.16).
	Card-locked warning appears on the monitor.	Memory card is locked.	Unlock the memory card using the write-protect switch (p.17).

Problem	Symptom	Cause	Solution
<p>Pictures are not sharp.</p>	<p>Focus signal is red and the viewfinder indicator lamp is green and blinking quickly.</p>	<p>Subject is too close.</p>	<p>Make sure the subject is within the autofocus range of 25cm (0.8ft.) to infinity.</p>
		<p>A special situation is preventing the autofocus system from focusing (p.25)</p>	<p>Use the focus-lock function to focus on an object at the same distance as the subject (p. 24).</p>
	<p>Pictures are taken indoors or in low-light situations without flash.</p>	<p>Slow shutter speeds result in blurred images when the camera is hand-held.</p>	<p>Use a tripod or the built-in flash (p. 26).</p>
<p>Only one picture can be taken with continuous drive.</p>	<p>The image quality is set to super fine.</p>		<p>Change the image-quality setting (p. 28).</p>
<p>While using flash, the pictures are too dark.</p>	<p>The subject is beyond the flash range: wide-angle position - 0.25m ~ 2.9m (0.8 ft. ~ 9.5 ft.), telephoto position - 0.25m ~ 2.3m (0.8 ft. ~ 7.5 ft.)(p. 27).</p>		<p>Move closer to the subject.</p>

Problem	Symptom	Cause	Solution
Subject appears too far to the right in the image.	Viewfinder was used for framing. Parallax is apparent with subjects closer than 1m (3ft.) at the zooms' wide-angle position or 3m (10ft) at the telephoto position.		Only use the LCD monitor for framing with close subjects.
Part of the image area is hidden behind a dark object.	Viewfinder was used to capture the image.	The lens was partially covered with an object or finger.	When using the viewfinder, take care not to cover the lens.

If the camera does not function normally, turn it off, remove and reinsert the battery, or unplug and reconnect the AC adapter. Always turn the camera off using the main switch otherwise the memory card may be damaged and camera settings reset.

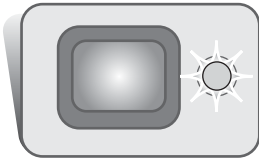

The indicator lamp next to the viewfinder can be used to diagnose camera operations. The lamp colors change between green, red, and orange, and the lamp can glow steadily or blink at two rates.

Color	State	Indication
Green	Steady	Camera ready to take an image.
	Blinking slowly	Camera-shake warning - shutter speed is below the limit where the camera can be safely hand-held. Use flash (p. 26) or tripod.
	Blinking quickly	The camera cannot focus. The subject is closer than 0.25m (0.8ft.) or a special situation is preventing the autofocus system from focusing (p. 25).
Red	Blinking quickly	Power is insufficient for camera operation.
		The flash is charging (while the shutter-release button is pressed partway down).
		The memory card is locked.
		The memory card is full.
Orange	Blinking quickly	The memory card cannot be used with the camera and may need to be formatted.
		The camera is accessing the memory card.

Removing the driver software – Windows

1. Insert a memory card in the camera and connect it to the computer with the USB cable. Other devices must not be connected to the computer during this procedure.
2. Right click on the My-computer icon. Select “properties” from the drop-down menu.

Windows XP: from the start menu go to the control panel. Click on the performance and maintenance category. Click “System” to open the system properties window.
3. Windows 2000 and XP: select the hardware tab in the properties window and click the device-manager button.

Windows 98 and Me: click the device-manager tab in the properties window.
4. The driver file will be located in the universal-serial-bus-controller or other-devices location of the device manager. Click on the locations to display the files. The driver should be indicated with the camera name. Under certain conditions, the driver name may not contain the camera name. However, the driver will be indicated by either a question mark or exclamation point.
5. Click on the driver to select it.
6. Windows 2000 and XP: click on the action button to display the drop-down menu. Select “uninstall.” A confirmation screen will appear. Clicking “Yes” will remove the driver from the system.

Windows 98 and Me: click the remove button. A confirmation screen will appear. Clicking “Yes” will remove the driver from the system.
7. Disconnect the USB cable and turn off the camera. Restart the computer.

Camera care

- Do not subject the camera to shock or impact.
- Turn off the camera when transporting.
- This camera is neither waterproof nor splashproof. Inserting or removing the battery or memory card, or operating the camera with wet hands may damage the camera.
- When at the beach or near water, take care not to expose the camera to water or sand. Water, sand, dust, or salt can damage the camera.
- Do not leave the camera under direct sunlight. Do not point the lens directly at the sun; the CCD may be damaged.
- When taking the camera from a cold to a warm environment, place it in a sealed plastic bag to prevent condensation from forming. Allow the camera to come to room temperature before removing it from the bag.

Memory cards

SD Memory Cards and MultiMediaCards are manufactured with precision electronic components.

The following may cause data loss or damage:

- Improper use of the card.
- Bending, dropping, or subjecting the card to impact.
- Heat, moisture, and direct sunlight.
- Static electrical discharge or electromagnetic fields near the card.
- Removing the card or interrupting the power supply while the camera or a computer is accessing the card (reading, writing, formatting, etc.).
- Touching the electrical contacts of the card with your fingers or metal objects.
- The disuse of a card for an extended period.
- Using the card beyond its life. Purchasing a new card periodically may be necessary.

The storage capability of the memory card will diminish with extended use. Minolta has no responsibility for any loss or damage to data. It is recommended that a copy of the card data be made.

Batteries

- Battery performance decreases with temperature. In cold environments, we recommend keeping spare batteries in a warm place, such as the inside of a coat. Batteries can recover their power when they warm up.
- Do not store the battery when it is fully charged.
- When storing the battery for extended periods, recharge the battery for five minutes every six months. The battery may not be able to be recharged if completely exhausted.

Cleaning

- If the camera or the outside of the lens is dirty, gently wipe it with a soft, clean, dry cloth. If the camera or lens comes in contact with sand, gently blow away loose particles. Wiping may scratch the surface.
- To clean the lens surface, first blow away any dust or sand, then, if necessary, moisten a lens tissue or soft cloth with lens cleaning fluid and gently wipe the lens.
- Never use organic solvents to clean the camera.
- Never touch the lens surface with your fingers.

Storage

- Store in a cool, dry, well-ventilated area away from dust and chemicals. When not in use for long periods, store the camera in an airtight container with a silica-gel drying agent.
- Remove the battery and memory card from the camera when not in use for extended periods.
- Do not store the camera in an area with naphthalene or mothballs.
- During long periods of storage, operate the camera occasionally. When taking the camera out of storage, check that the camera is functioning properly before using.

LCD monitor care

- Although the LCD monitor is manufactured using high precision technology, there may occasionally be a lack of color or bright points on the LCD monitor.
- Do not apply pressure to the surface of the LCD monitor; it may be permanently damaged.
- In a cold environment, the LCD monitor may become temporarily dark. When the camera warms up, the display will function normally.
- The LCD monitor may be slow to react in low temperatures or may turn dark in a hot environment. When the camera reaches normal operating temperature, the display will function normally.
- If fingerprints are on the LCD monitor surface, gently wipe with a soft, clean, dry cloth.

Copyright

- TV program, films, video tapes, photographs, and other materials may be copyrighted. Unauthorized recording or duplication of such material may be contrary to copyright laws. Taking pictures or images of performances, exhibitions, etc., is prohibited without approval and can infringe on copyright. Images protected by copyright can only be used under the provisions within the copyright laws.

Before important events or journeys

- Check the camera's operation; take test pictures and recharge the battery.
- Minolta has no responsibility for any damage or loss incurred by equipment malfunction.

Questions and service

- If you have questions about your camera, contact your local camera dealer or write to the Minolta distributor in your area.
- Before shipping your camera for repair, please contact a Minolta Service Facility.

The following marks may be found on the product:



This mark on your camera certifies that this camera meets the requirements of the EU (European Union) concerning interference causing equipment regulations. CE stands for Conformité Européenne (European Conformity).

This Class B digital apparatus complies with Canadian ICES-003.

Cet appareil numérique de la classe B est conforme à la norme NMB-003 du Canada.

Digital Camera: DiIMAGE X



Tested To Comply
With FCC Standards

FOR HOME OR OFFICE USE

This device complies with Part 15 of the FCC Rules. Operation is subject to the following two conditions: (1) This device may not cause harmful interference, and (2) this device must accept any interference received, including interference that may cause undesired operation. Changes or modifications not approved by the party responsible for compliance could void the user's authority to operate the equipment. This equipment has been tested and found

to comply with the limits for a Class B digital device, pursuant to Part 15 of the FCC Rules. These limits are designed to provide reasonable protection against harmful interference in a residential installation. This equipment generates, uses and can radiate radio frequency energy and, if not installed and used in accordance with the instructions, may cause harmful interference to radio communications. However, there is no guarantee that interference will not occur in a particular installation. If this equipment does cause harmful interference to radio or television reception, which can be determined by turning the equipment off and on, the user is encouraged to try to correct the interference by one or more of the following measures:

- Reorient or relocate the receiving antenna.
- Increase the separation between the equipment and the receiver.
- Connect the equipment to an outlet on a circuit different from that to which the receiver is connected.
- Consult the dealer or an experienced radio/TV technician for help.

Tested by the Minolta Corporation 101 Williams Drive, Ramsey, New Jersey 07446, U.S.A.

TECHNICAL SPECIFICATIONS

Number of effective pixels: CCD:	1.96 million 1/2.7-type interline complementary-color CCD with a total of 2.11 million pixels.
Camera sensitivity (ISO):	Automatic (between ISO 100 - 200 equivalent.)
Aspect ratio:	4:3
Lens construction:	9 elements in 8 groups.
Maximum aperture:	f/2.8 - f/3.6
Focal length:	5.7 - 17.1 mm (35mm equivalent: 37 - 111 mm)
Focusing range:	0.25 m - infinity (from the front of the camera)
Autofocusing system:	Video AF
Shutter:	CCD electronic shutter plus mechanical shutter
Shutter speeds:	2 - 1/1000s
Built-in flash recycling time:	Approximately 6 seconds
Viewfinder:	Optical real-image zoom viewfinder.
Monitor LCD:	3.8 cm TFT color
Monitor field of view:	Approximately 100%
A/D conversion:	12 bits
Recording media:	SD Memory Cards and MultiMediaCards
File formats:	Exif 2.1 (JPEG, TIFF), motion JPEG (MOV), WAV. DCF 1.0 and DPOF compliant.
Print Image Matching:	Yes
Menu languages:	Japanese, English, German, French, and Spanish
Video output:	NTSC and PAL
Battery:	Minolta NP-200 lithium-ion battery.

Battery performance (recording):	Approximately 120 frames: based on Minolta's standard test method: NP-200 lithium-ion battery, LCD monitor on, full-size images (1600 X 1200), standard image quality, no instant playback, no voice memo, flash used with 50% of the frames. Approximately 190 frames: based on Minolta's standard test method: NP-200 lithium-ion battery, LCD monitor off, full-size images (1600 X 1200), standard image quality, no instant playback, no voice memo, flash used with 50% of the frames.
Battery performance (playback):	Approximate continuous playback time: 120 min. Based on Minolta's standard test method: NP-200 lithium-ion battery, LCD monitor on, no audio playback.
External power source:	AC adapter (AC-4 or AC-5)
Dimensions:	84.5 (W) X 72.0 (H) X 20 (D) mm
Weight:	Approximately 135g (without battery or recording media)
Operating temperature:	0° - 40°C
Operating humidity:	5 - 85% (noncondensing)
Lithium-ion battery NP-200	
Voltage:	3.7V
Weight:	20.5g
Dimensions	31.5 (W) X 52.6 (H) X 6.5 (D) mm
Battery charger BC-200	
Input voltage:	AC100-240V, 50/60Hz
Weight:	75g
Dimensions	65 (W) X 80 (H) X 25.8 (D) mm

Specifications are based on the latest information available at the time of printing and are subject to change without notice.

MINOLTA

©2001 Minolta Co., Ltd. under the Berne Convention and the Universal Copyright Convention.

Printed in Japan