

MINOLTA

The essentials of imaging

www.minoltaeurope.com

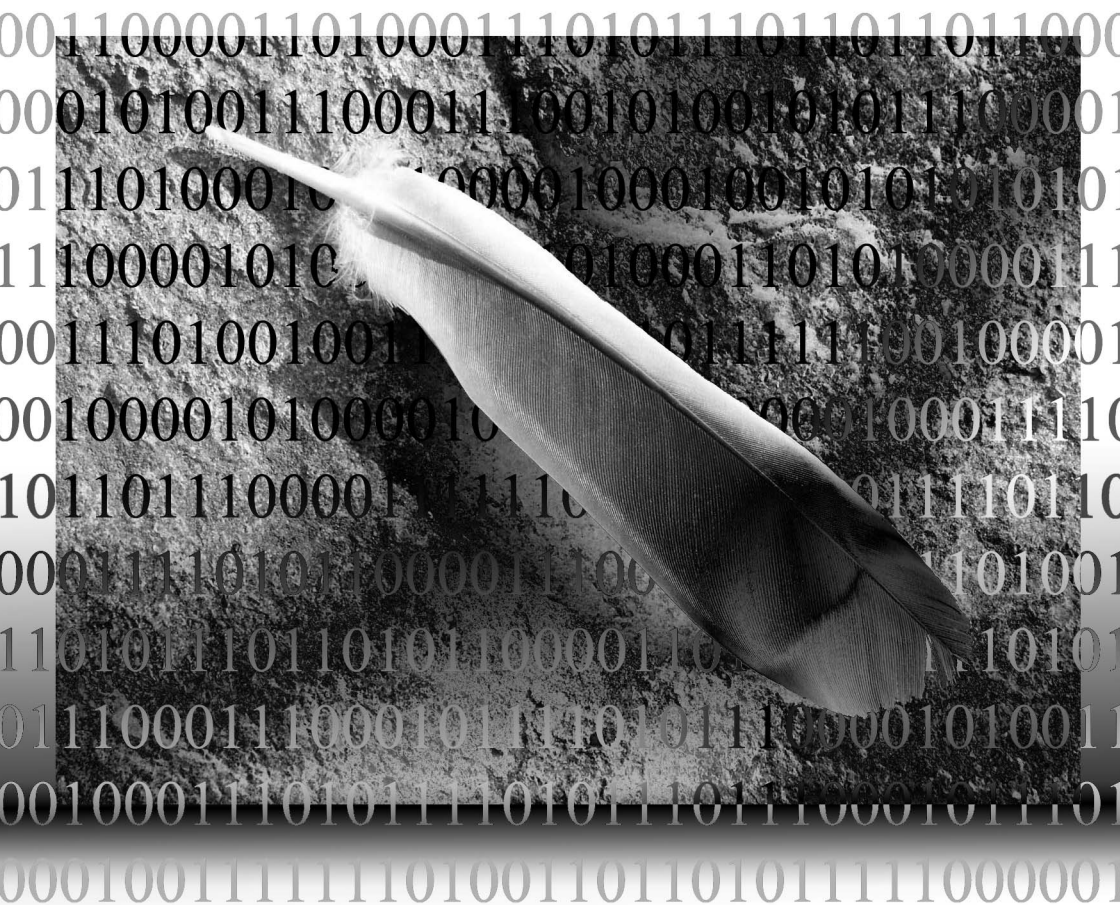

***DiMAGE* Scan Elite 5400**

For proper and safe use

Read and understand all warnings and cautions before using this product.

WARNING

- Use only within the voltage range specified on the unit. Inappropriate current may cause damage or injury through fire or electric shock.
- Use only the specified AC adapter (Ya Hsin Industrial 019-240840) within the voltage range indicated on the adapter unit. An inappropriate adapter or current may cause damage or injury through fire or electric shock.
- Do not disassemble this product. Electric shock may cause injury if a high-voltage circuit inside the product is touched. Take the product to a Minolta Service Facility when repairs are required.
- Immediately unplug the unit and discontinue use if the product is dropped or subjected to an impact in which the interior is exposed. The continued use of a damaged product may cause injuries or fire.
- Store this product out of reach of children. Be careful when around children not to harm them with the product or parts.
- Do not operate this product or handle the power cord with wet hands. Do not place a container with liquid near the product. If liquid comes in contact with the product, immediately unplug the unit. The continued use of a product exposed to a liquid may cause damage or injury through fire or electric shock.
- Do not insert hands, inflammable objects, or metal objects such as paper clips or staples into this product. It may cause damage or injury through fire or electric shock. Discontinue use if an object enters the product.
- Do not use the product near inflammable gases or liquids such as gasoline, benzine, or paint thinner. Do not use inflammable products such as alcohol, benzine, or paint thinner to clean the product. The use of inflammable cleaners and solvents may cause an explosion or fire.
- When unplugging the unit, do not pull on the power cord. Hold the adapter unit when removing it from an outlet.
- Do not damage, twist, modify, heat, or place heavy objects on the power cord. A damaged cord may cause damage or injury through fire or electric shock.
- If the product emits a strange odor, heat, or smoke, discontinue use. Immediately unplug the product. The continued use of a damaged product or part may cause injuries or fire.
- Take the product to a Minolta Service Facility when repairs are required.

CAUTION

- Damage or injury through fire or electric shock may result if the product is used or stored in the following conditions:
 - In humid or dusty environments
 - In direct sunlight or hot environments
 - In smoky or oily areas
 - In unventilated areas
 - On unstable or unlevel surfaces

- This product should only be operated in the upright position. Inappropriate placement may result in fire.
- Insert the plug securely into the electrical outlet.
- Do not use if the cord is damaged.
- Do not connect the ground to a gas pipe, telephone ground, or water pipe. Improper grounding can result in injury from electric shock.
- Do not cover the AC adapter. A fire may result.
- Do not obstruct access to the AC adapter; this can hinder the unplugging of the unit in emergencies.
- Unplug the product when cleaning or when the unit is not in use for long periods.
- Periodically check that the power cord is not damaged and the plug is clean. Dust and dirt that may collect between the prongs of the plugs may result in fire.

Every necessary precaution has been taken to ensure the accuracy of this instruction manual. Minolta is not responsible for any loss or damage caused from the operation of this product. This manual may not be copied in part or whole without prior written permission from Minolta.



As an Energy Star® Partner, Minolta has determined that this product meets the Energy Star guidelines for energy efficiency.



This mark certifies that this product meets the requirements of the EU (European Union) concerning interference causing equipment regulations. CE stands for Conformité Européenne.

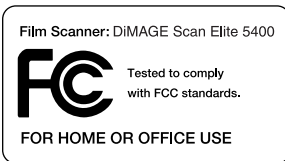

This device complies with Part 15 of the FCC Rules. Operation is subject to the following conditions: (1) This device may not cause harmful interference, and (2) this device must accept any interference received, including interference that may cause undesired operation.

Tested by the Minolta Corporation 101 Williams Drive Ramsey, New Jersey 07446 USA.

Do not remove the ferrite cores from the cables.

This Class B digital apparatus complies with Canadian ICES-003.

Cet appareil numérique de la classe B est conforme à la norme NMB-003 du Canada.

The sound pressure level is less than 70dB according to ISO 3744 or ISO 7779.

Microsoft, Windows, Windows 98, Windows Me, Windows 2000 Professional, and Windows XP are registered trademarks of the Microsoft Corporation. Macintosh, Apple, and Power Macintosh are registered trademarks of Apple Computer, Inc. Adobe and Photoshop are registered trademarks of Adobe Systems Incorporated. CorelPhotoPaint is a trademark of the Corel Corporation. Paint Shop Pro is the copyright of Met's Corporation. Digital ICE3, Digital ICE, Digital ROC, and Digital GEM are trademarks of registered trademarks and technologies of Applied Science Fiction, Inc in U. S. A. Other corporate and product names are the trademarks and registered trademarks of their respective companies.

Before you begin

Thank you for purchasing this Minolta product. Please take the time to read through this instruction manual so you can enjoy all the features of your new scanner.

Check the packing list before using this product. If any items are missing, immediately contact your dealer.

DiMAGE Scan Elite 5400 scanner

Scanner Stand

Slide Mount Holder SH-M10

35mm Film Holder FH-M10

USB Cable UC-2

IEEE1394 Cable FC-2

AC Adapter

Reset Tool

DiMAGE Scan Utility CD-ROM

Adobe Photoshop Elements 2.0 CD-ROM

DiMAGE Instruction Manuals-CD-ROM:

DiMAGE Scan Elite 5400 hardware instruction manual (PDF)

DiMAGE Scan software instruction manual (PDF)

Quick Reference Guide

Minolta International Warranty Certificate

The AC adapter unit varies with region. AC-U25 is for use in North America, Taiwan, and Japan. AC-U22 is for use in continental Europe, Oceania, and Asia (except China and Hong Kong). AC-U23 is for use in the United Kingdom and Hong Kong. AC-U24 is for China.

Table of contents

This manual contains information specific to this model scanner. This includes hardware setup and use as well as notes about software operation, compatibility, and system requirements. See the supplied DiMAGE Scan Utility software manual for information on the installation and operation of the scanner software.

System requirements	6
Names of parts	7
Scanner setup	7
Attaching the scanner stand	7
Before connecting the scanner to a computer	8
Connecting the USB cable	8
Connecting the IEEE 1394 (FireWire) cable	9
Connecting the AC adapter	9
Turning on the scanner	9
Loading the film holders	10
Handling film	10
Where is the emulsion?	10
Loading 35mm film strips	10
Loading mounted slides.....	11
Loading a film holder into the scanner	12
Ejecting a film holder	12
Scanner notes	13
Compatibility with the DiMAGE Scan Utility	13
Film format and type settings	13
Scanner resolution.....	13
Scanner color profiles	13
The Quick Scan button and DiMAGE Scan Launcher.....	14
Pixel Polish system requirements	15
Manual focus dial.....	16
Digital ICE system requirements	17
Adobe Photoshop Elements	17
Job file list	18
Disconnecting the scanner	19
Troubleshooting	20
Checking software installation - Windows	21
Closing the scanner door	22
Technical support.....	22
Warranty and product registration	22
Technical specifications	23

System requirements

The computer and the operating system must be guaranteed by the manufacturer to support IEEE 1394 (FireWire), or USB interface. To use the scanner, your computer system must meet the following requirements:

Pentium 166 Mhz or later processor. Pentium III or later recommended.	PowerPC G3 or later. PowerPC G4 or later recommended.
USB: Windows 98, 98 Second Edition, 2000 Professional, Me, or XP. IEEE 1394: Windows 2000 Professional, Me, or XP	USB: Mac OS 8.6 to 9.2.2 and Mac OS 10.1.3 to 10.1.5 and 10.2.1 to 10.2.3 FireWire: Mac OS 8.6* to 9.2.2 and Mac OS 10.2.1 to 10.2.3
A minimum of 128MB of RAM.	A minimum of 128MB of RAM in addition to the requirements for the Mac OS and appli- cations.
600MB or more of available hard-disk space is required.	
800 X 600 monitor capable of displaying High Color (16 bit) is required. 1024 x 768 monitor is recommended.	800 X 600 monitor capable of displaying at least 32,000 colors is required. 1024 x 768 monitor is recommended.
IEEE1394 (FireWire) or preinstalled USB (ver. 2.0 or 1.1) interface	
Recommended IEEE boards Adaptec FireConnect 4300, PROCOMP SpeedDemon 400P, or OHCI compatible non-DV dedicated IEEE1394 ports guaranteed by the computer manufacturer. Recommended USB boards Adaptec USB2connect 3100, Adaptec USB2connect 5100, Adaptec DuoConnect, Belkin Hi-speed USB 2.0 5-Port PCI, Belkin Hi-speed USB 2.0 2-Port PCI, or port sup- plied with the computer.	Apple FireWire or USB port
TWAIN driver compatible with Photoshop 6.0.1, and 7.0.1, Photoshop Elements 2.0, Paint Shop Pro 7.0, CorelPhotoPaint 11.0.	Plug-in compatible with Photoshop 6.0.1, and 7.0.1, Photoshop Elements 2.0,

* To use preinstalled Mac OS 8.6 with a built-in FireWire port, a Firewire 2.2 to 2.3.3 extension must be installed. This software can be downloaded free of charge from the apple web site at <http://www.apple.com>.

Check the Minolta web site for the latest compatibility information:

North America: <http://www.minoltausa.com>

Europe: <http://www.minoltasupport.com>

Names of parts

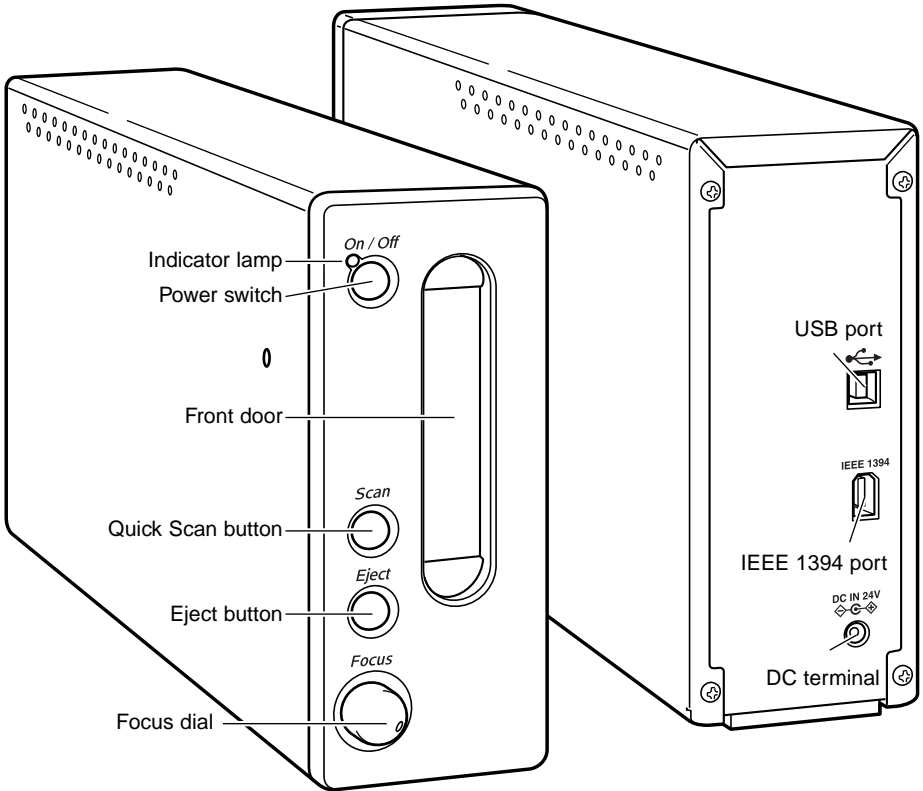

Do not use the focus dial until it has been activated in the DiIMAGE Scan Utility's preferences dialog box. See the DiIMAGE Scan software manual for details.

Scanner setup

Attaching the scanner stand

A scanner stand has been supplied for added stability. Simply place the scanner in the stand. The feet on the bottom of the scanner unit should not rest on the stand.

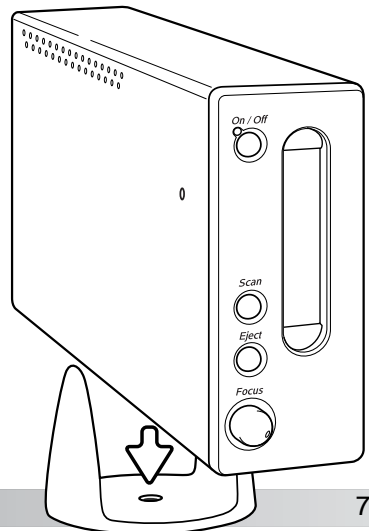

Before connecting the scanner to a computer



Before connecting the scanner to a computer, the DiMAGE Scan Utility must first be installed. Read the software instruction manual for the installation procedure.

The scanner should be placed on a level surface free from vibrations. It should be located away from direct sunlight and in a clean, dry, well-ventilated area. Never connect the scanner cable while data is being transferred between the computer and peripheral devices.

Connecting the USB cable

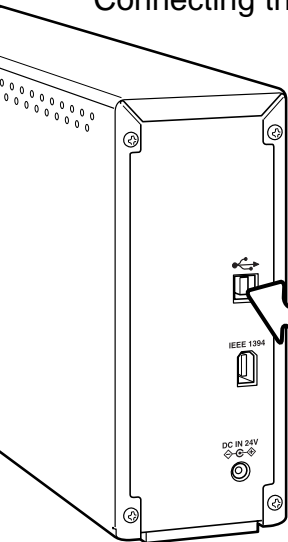

Securely plug the A connector of the USB cable into the scanner's USB port and the B connector into the computer's USB port.

The scanner should be connected directly to the computer. Attaching the scanner to a USB hub may prevent proper operation.

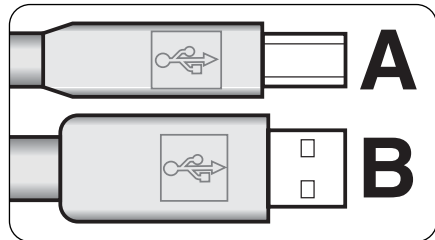

When the scanner is initially connected to a computer with a Windows 98, 98SE, or 2000 Professional operating system, the found-new-hardware wizard will appear briefly. No action is required. With Windows 2000, the "Digital Signature Not Found..." message may appear. Click the yes button to complete the scanner installation.

When the scanner is initially connected to a computer with a Windows XP operating system, the found-new-hardware wizard will appear. Click the next button. The "not passed Windows Logo testing" message appears. Click the continue-anyway button to complete the scanner installation.

Connecting the IEEE 1394 (FireWire) cable

Securely plug the cable into the scanner's and computer's IEEE 1394 port. Either end of the cable can be connected to the IEEE 1394 port on the scanner or computer.

The scanner should be connected directly to the computer. Attaching the scanner to an IEEE hub may prevent proper operation.

When the scanner is initially connected to a computer with a Windows 98, 98SE, or 2000 Professional operating system, the found-new-hardware wizard will appear briefly. No action is required. With Windows 2000, the "Digital Signature Not Found..." message may appear. Click the yes button to complete the scanner installation.

When the scanner is initially connected to a computer with a Windows XP operating system, the found-new-hardware wizard will appear. Click the next button. The "not passed Windows Logo testing" message appears. Click the continue-anyway button to complete the scanner installation.

Connecting the AC adapter

1. Connect the output plug of the AC adapter to the scanner's DC terminal.
2. Plug the AC adapter into a standard household outlet.

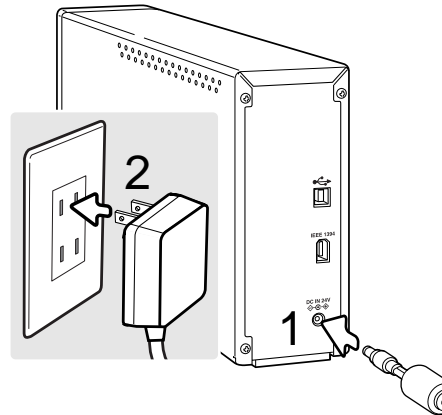
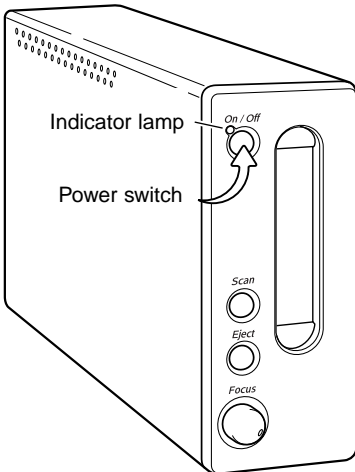

Turning on the scanner

Turn on the scanner with the power switch. Start up the computer.

When launching the DiIMAGE Scan Utility, the indicator lamp will blink when the scanner is initializing. Once the indicator lamp glows steadily, the scanner can be used.

When using an IEEE1394 interface with Windows Me, always shut down the computer before turning the scanner off. Otherwise a system error may result.

Loading the film holders

Handling film

To achieve the best possible reproduction from the scanner, the film and film holder should be free from dust and dirt. Always work with processed film in a clean, dust-free environment. Handle film by the edges or mount to prevent fingerprints and dirt marring the image area. Special lint free gloves are available from photographic equipment retailers for film handling as well as anti-static cloths, brushes, and blowers for removing dust. Film cleaner can be used to remove oil, grease, or dirt from film; carefully follow the manufacturer's instructions and precautions for the film cleaning solvent.

Where is the emulsion?

When film is scanned, the emulsion side of the film should be down. When viewing the film image, if the image is orientated correctly rather than a mirror image, the emulsion side is facing down. If the image is abstract or symmetrical so its orientation is difficult to determine, the emulsion is down if the frame numbers and edge markings can be read correctly. With mounted slides, the emulsion is on the same side of the mount as the film manufacturer's or processor's name is printed.

Loading 35mm film strips

Film strips of up to six frames can be loaded into the FH-M10 film holder. To open the holder, lift the latch and open the cover (1).

With the emulsion down, place the film in the holder and under the retaining tabs. Align the film with the frame apertures. The up arrow on the the film holder indicates the orientation of horizontal images.

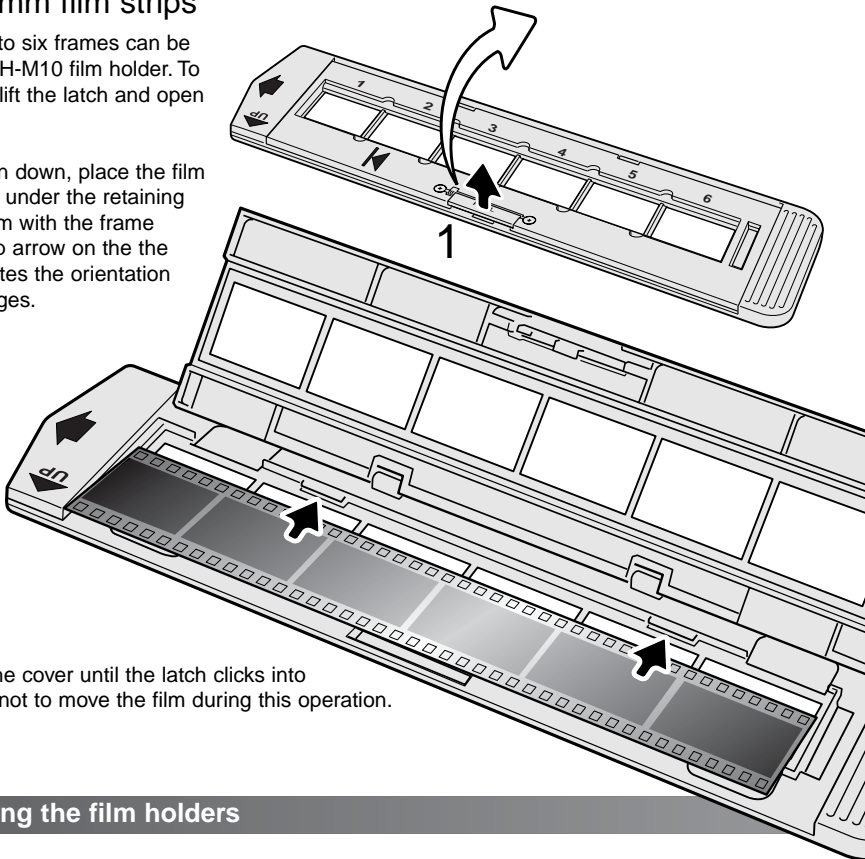

Carefully lower the cover until the latch clicks into place. Take care not to move the film during this operation.

Loading mounted slides

Up to four mounted 35mm or APS slides can be inserted into the slide mount holder. The slide mounts must be between 1 mm and 3.2 mm thick to fit the holder. Glass mounts cannot be used; the glass refracts the light resulting in distorted and unevenly illuminated scans. Do not leave slide mounts in the holder.

To open the holder, lift the latches and open the cover.

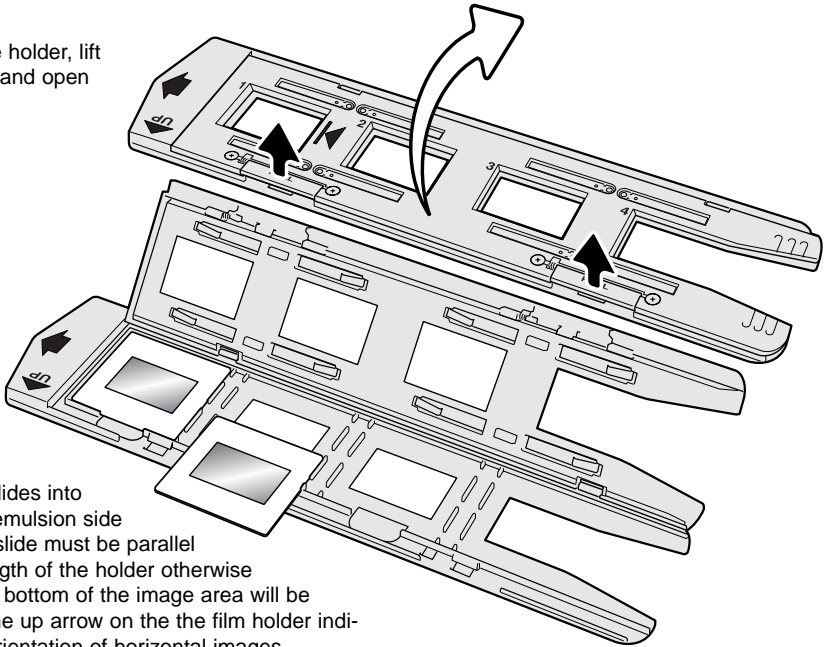

Insert the slides into the holder emulsion side down. The slide must be parallel with the length of the holder otherwise the top and bottom of the image area will be cropped. The up arrow on the the film holder indicates the orientation of horizontal images.

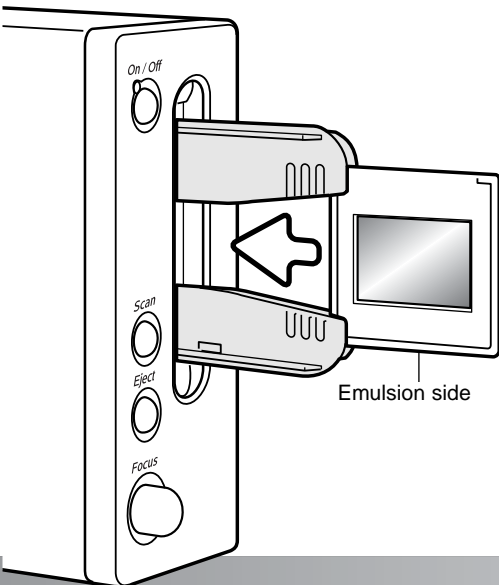

When the slide mount holder is in the scanner, the last slide can be removed and a new slide inserted without ejecting the holder. When replacing slide, take care not to change the holder position. A pre-scan should be made each time a slide is inserted; refer the DiMAGE Scan manual.

Loading a film holder into the scanner

Before using the scanner, install the DiIMAGE Scan Utility; see the software instruction manual. Turn on the scanner and then start the computer. Launch the DiIMAGE Scan Utility before inserting the film holder. Do not insert the film holder into the scanner while the utility software is launching or the scanner is initializing; the indicator lamp blinks during this period.

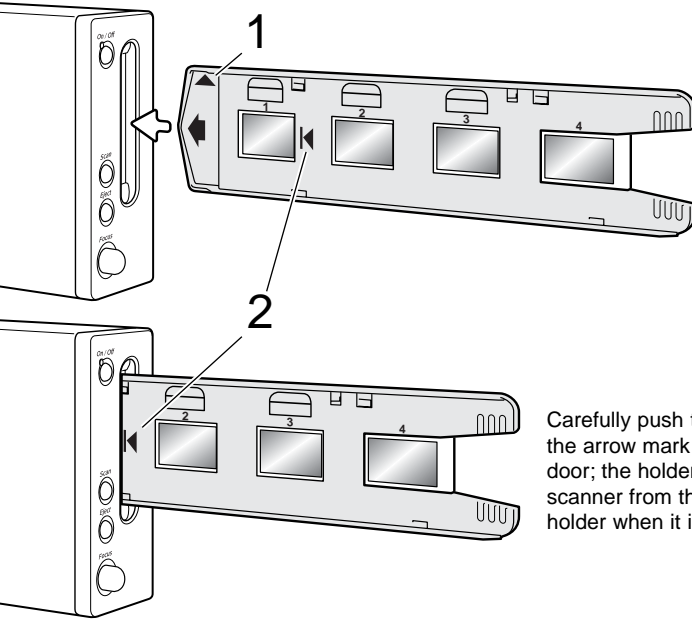

When the indicator lamp glows steadily, insert the film holder into the scanner in the direction indicated by the arrow. Hold the holder straight and level with the orientation indicator up (1).

Carefully push the holder into the scanner until the arrow mark (2) is aligned with the scanner door; the holder will be automatically fed into the scanner from that point. Never touch or hinder the holder when it is in the scanner.

Ejecting a film holder

Use the eject button on the scanner body or in the DiIMAGE Scan Utility window to remove the holder; the scanner automatically ejects the holder to its initial insertion position. Do not touch or hinder the holder while it is moving. If the scanner is turned off before the holder is ejected, turn on the scanner; the holder is automatically ejected.

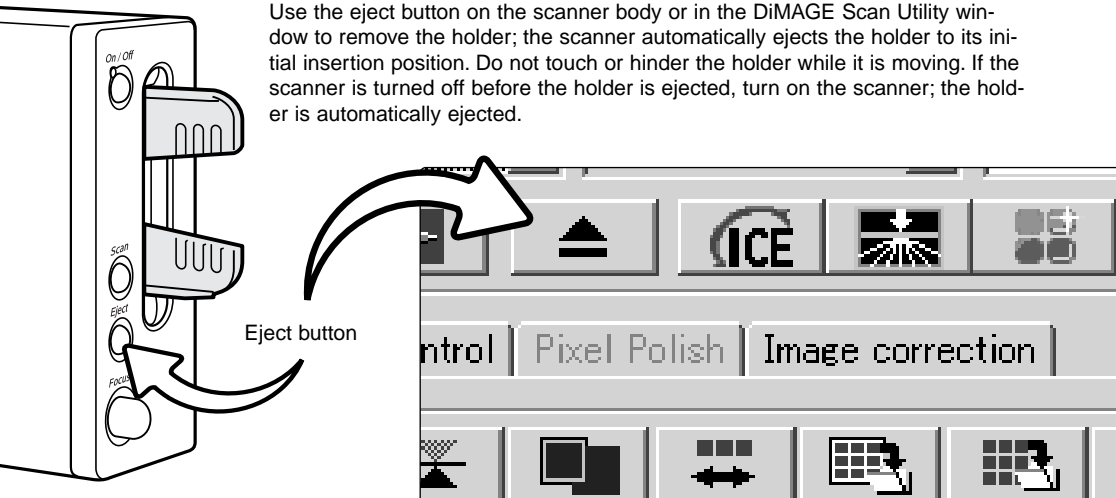

Scanner notes

Compatibility with the DiMAGE Scan Utility

The DiMAGE Scan software is compatible with many of Minolta's high-end film scanners. This means only one scanner driver needs to be installed on a computer with multiple scanner models connected.

Because of the differences in specifications between scanners, some of the DiMAGE Scan functions cannot be used with this scanner model. The following functions described in the DiMAGE Scan software manual are not available:

Digital ROC
Digital GEM

Film format and type settings

When scanning, the film type must be selected in the main window of the DiMAGE Scan Utility. This scanner does not use glass holders and so the holder-type drop-down menu is deselected and the film format cannot be changed. See scanner setup in the basic-scanning section of the software manual.

Film type can be selected between color and black and white, positive and negative film. Film for prints is negative film. Slide film is positive film.

Scanner resolution

The maximum resolution for this scanner is 5400 dpi. The input resolution that can be entered in the DiMAGE Scan Utility is from 337 dpi to the maximum resolution of 5400 dpi.

Scanner color profiles

When the DiMAGE Scan Utility is installed, the scanner profiles listed below are automatically installed for this model scanner, see the software manual for location. These profiles have been included for advanced color matching with profile-to-profile conversions in sophisticated image-processing or DTP applications. When using these profiles, the color reproduced may not be the same as the color matching system in the utility software. See the color matching section in the DiMAGE Scan software manual for the profile location.

MLTF5400.icc - used with positive film at any color depth other than 16-bit linear.

MLTF5400p.icc - used with positive film with 16-bit linear color depth.

The Quick Scan button and DiMAGE Scan Launcher

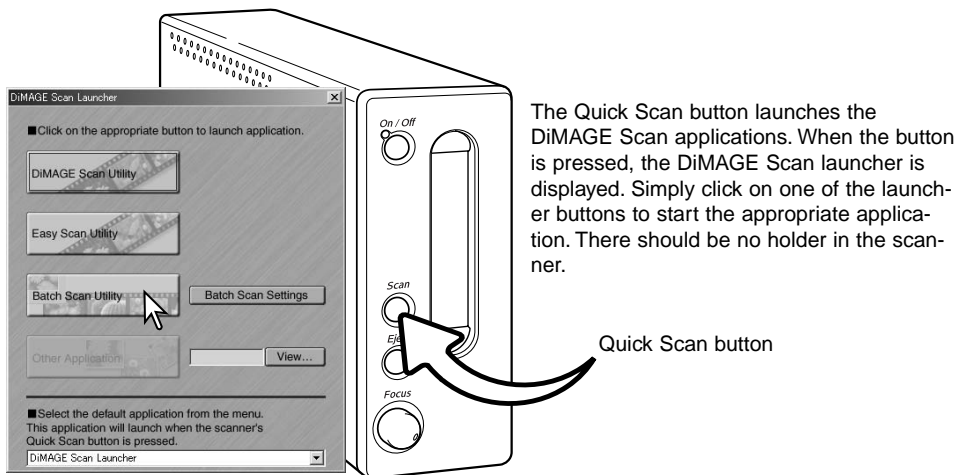

The Quick Scan button launches the DiMAGE Scan applications. When the button is pressed, the DiMAGE Scan launcher is displayed. Simply click on one of the launcher buttons to start the appropriate application. There should be no holder in the scanner.

Quick Scan button

When the Batch Scan Utility button is clicked, the scanner will initialize. When the set-holder message appears, insert the holder into the scanner; all the frames in the holder will be scanned and saved, and the holder will be ejected automatically. To scan another batch, change the film in the holder and reinsert it into the scanner. Click the Batch Scan Utility button to begin scanning. The scanner only needs to be initialized before the first holder is scanned.

To change or confirm the Batch Scan settings, click the settings button. See the Batch Scan Utility section in the DiMAGE Scan software manual for details.

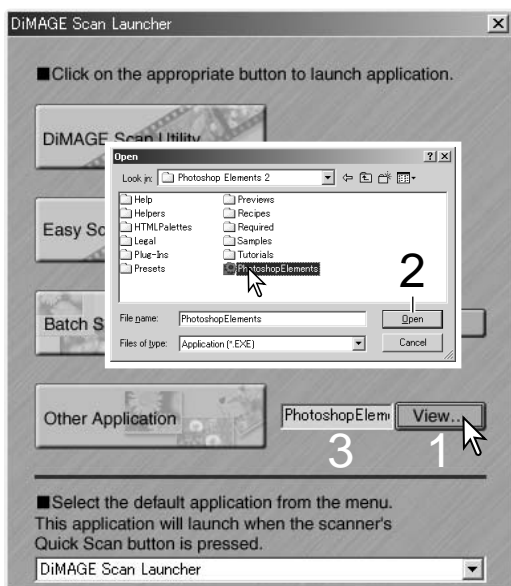

The launcher can be used to directly open an image-processing application with which the scanner will be used.

To specify the application, click the view button (1); the open dialog box will be displayed. Locate and click on the application to highlight it. Click the open button (2) to complete the procedure; the name of the application will be displayed in the launcher (3).

■ Select the default application from the menu.
This application will launch when the scanner's Quick Scan button is pressed.

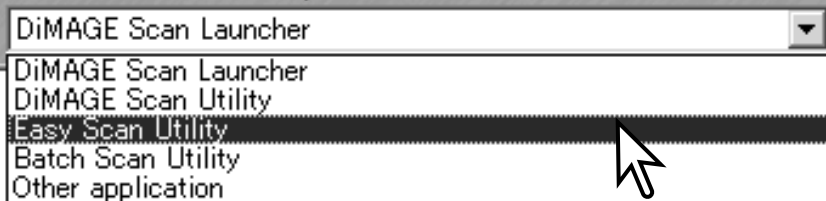

The Quick Scan button can be used to launch a single application directly. Simply select the application from the drop-down menu at the bottom of the launcher; each time the Quick Scan button is pressed, that application will open along with the launcher.

If the Batch Scan Utility is selected, the first time the Quick Scan button is pressed the scanner initializes and then the message to insert the holder is displayed. To scan subsequent holders, simply insert the holder and press the Quick Scan button.

Pixel Polish system requirements

The computer must meet the system requirements below to use Pixel Polish.

PC / AT compatible computers	Macintosh computers
256 MB of RAM. 512 MB recommended.	256 MB of RAM in addition to the requirements for the OS and applications. 512 MB recommended.
1.2 GB of hard-disk space. 2.0 GB recommended.	

Mac OS 8.6 - 9.2.2: allocate the RAM requirements above to the Easy Scan Utility or DiIMAGE Scan Utility when used alone. When using the DiIMAGE Scan Utility through an image-processing application, add the memory requirements to the host software.

Windows 2000 or XP: set the virtual memory to four times the RAM required above.

Manual focus dial

The scanner can be focused manually using the focus dial. The manual focus dial must first be activated in the DiMAGE Scan Utility preferences window, see “Setting scanner preferences” in the advanced scanning section of the software manual. When the manual focus dial is active the scanner’s autofocus system is disabled and the other scanner focusing functions will not work.

With the image displayed in the prescan tab, click the manual-focus button. The mouse pointer will change to the manual-focus cursor. To cancel the function, click the manual-focus button again.

Click on the area of image to be used for focus. For best results, select an area within the image with contrast or detail. The manual focus function cannot focus on a low-contrast detail such as a cloudless or overcast sky. The focus meter window will appear.

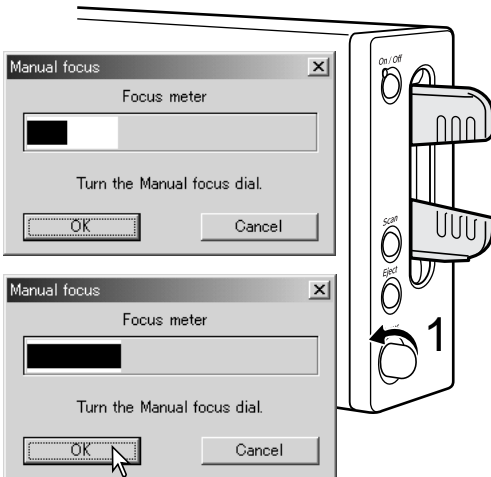
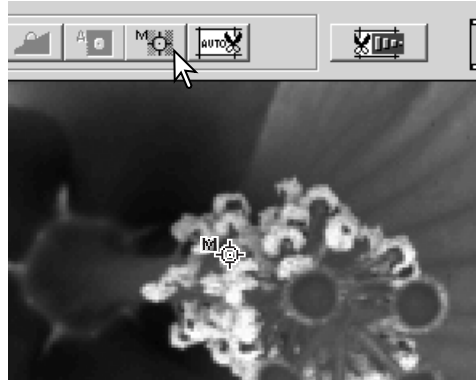

Turn the focus dial (1) until the black and white bars are at their longest extension. The black bar indicates the change in focus. The white bar indicates the longest extent of the black bar and the point of sharpest focus. Do not touch or hinder the holder.

Click OK or press the keyboard return/enter key to set the focus. A new prescan will start and replace the previous image.

For the best results, each image scanned should be focused individually. When the holder is ejected, the manual focus position is reset.

Digital ICE system requirements

The computer must meet the system requirements below to use Pixel Polish.

PC / AT compatible computers	Macintosh computers
256 MB of RAM. 512 MB recommended.	256 MB of RAM in addition to the requirements for the OS and applications. 512 MB recommended.
1.2 GB of hard-disk space. 2.0 GB recommended.	

Adobe Photoshop Elements

Take time to register your copy of Photoshop Elements with Adobe. You can register online, by fax, or by mail. The software can be registered online during installation by following the instructions on the installer screens. To register by fax or mail, read the instructions in the registration folder located in the technical-information folder on the Adobe Photoshop Elements CD-ROM.

PC / AT compatible computers	Macintosh computers
Pentium processor	PowerPC processor
Windows 98, 98 Second Edition, Me, 2000, or XP.	Mac OS 9.1, 9.2.x, or Mac OS X 10.1.3 to 10.1.5.
Internet Explorer 5.0, 5.5, or 6.0.	128 MB of RAM (with virtual memory on)
128 MB of RAM	
150 MB of available hard disk space	350 MB of available hard disk space
Color monitor capable of displaying thousands of colors at a resolution of 800 X 600 or greater.	

The DiMAGE Scan Utility can be opened from Photoshop Elements with the import option on the file menu. For Macintosh systems, the DiMAGE Scan Utility plug-in module must first be installed in the Photoshop Elements import/export folder located in the plug-in folder.

Files saved with a 16-bit or 16-bit linear color depth cannot be opened in Adobe Photoshop Elements. Refer to setting scanner preferences in the advanced scanning section in the DiMAGE Scan software manual.

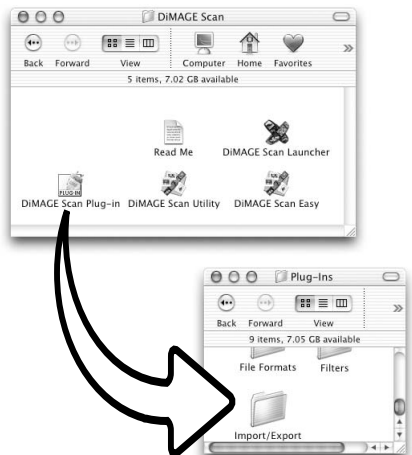

Job file list

Jobs can be used to make scan settings based on the final use of the image. See making-the-final-scan section in the DiIMAGE Scan software manual. The following charts list the parameters of the scanner's Job files:

CATEGORY	JOB NAME	INPUT RES.	OUTPUT RES.	MAG.	UNIT	INPUT SIZE W	INPUT SIZE H	INPUT LOCK	OUTPUT SIZE W	OUTPUT SIZE H	OUTPUT LOCK
Default	Default	1350	300	450	pixel	1950	1308	OFF	1950	1308	OFF
ColorLaserPrinter	A4Full	5120	600	853	mm	34.82	24.62	OFF	297	210	ON
	A4Half	3609	600	601	mm	34.94	24.63	OFF	210	148	ON
	A4Quarter	2560	600	426	mm	34.74	24.65	OFF	148	105	ON
	LetterFull	5264	600	877	inch	1.24	0.97	OFF	10.9	8.5	ON
	LetterHalf	3531	600	588	inch	1.45	0.93	OFF	8.5	5.45	ON
	LetterQuarter	2632	600	438	inch	1.24	0.97	OFF	5.45	4.25	ON
Photosensitive	A3Full	4828	400	1207	mm	34.8	24.61	OFF	420	297	ON
	A4Full	3414	400	853	mm	34.82	24.62	OFF	297	210	ON
	A5Full	2405	400	601	mm	34.94	24.63	OFF	210	148	ON
	LetterFull	3510	400	877	inch	1.24	0.97	OFF	10.9	8.5	ON
	LetterHalf	2354	400	588	inch	1.45	0.93	OFF	8.5	5.45	ON
	LetterQuarter	1755	400	438	inch	1.24	0.97	OFF	5.45	4.25	ON
	8x10	3303	400	825	inch	1.21	0.97	OFF	10	8	ON
	11x14	4535	400	1133	mm	31.42	24.62	OFF	356	279	ON
	10x12	4129	400	1032	mm	29.55	24.61	OFF	305	254	ON
	2L	2065	400	516	mm	34.5	24.61	OFF	178	127	ON
	PostCard4x6	1662	400	415	inch	1.45	0.96	OFF	6	4	ON
	Ink-Jet & Dye-Sub Printer	A2Full	5120	300	1706	mm	34.82	24.62	OFF	594	420
SuperB		4010	300	1336	mm	36.15	24.63	OFF	483	329	ON
A3Full		3620	300	1206	mm	34.83	24.63	OFF	420	297	ON
A4Full		2560	300	853	mm	34.82	24.62	OFF	297	210	ON
A4Half		1805	300	601	mm	34.94	24.63	OFF	210	148	ON
A4Quarter		1280	300	426	mm	34.74	24.65	OFF	148	105	ON
LetterFull		2632	300	877	inch	1.24	0.97	OFF	10.9	8.5	ON
LetterHalf		1766	300	588	inch	1.45	0.93	OFF	8.5	5.45	ON
LetterQuarter		1316	300	438	inch	1.24	0.97	OFF	5.45	4.25	ON
Photo4x6		1227	300	409	mm	36.67	24.45	OFF	150	100	ON
Photo3x5		1085	300	361	mm	35.18	24.65	OFF	127	89	ON
Web Page		1240x836	863	72	1198	pixel	1240	836	OFF	1240	836
	1112x750	775	72	1076	pixel	1112	750	OFF	1112	750	ON
	984x663	685	72	951	pixel	984	663	OFF	984	663	ON
	792x534	552	72	766	pixel	792	534	OFF	792	534	ON
	760x512	529	72	734	pixel	760	512	OFF	760	512	ON
	600x404	417	72	579	pixel	600	404	OFF	600	404	ON
	320x240	338	72	469	pixel	320	240	OFF	320	240	ON
Photo CD	PhotoCD2048x3072	2127	300	709	pixel	3072	2048	OFF	3072	2048	ON
	PhotoCD1024x1536	1064	300	354	pixel	1536	1024	OFF	1536	1024	ON
	PhotoCD512x768	532	300	177	pixel	768	512	OFF	768	512	ON
Screen	1920x1200	1330	72	1847	pixel	1920	1200	OFF	1920	1200	ON
	1600x1200	1239	72	1720	pixel	1600	1200	OFF	1600	1200	ON
	1280x1024	1057	72	1468	pixel	1280	1024	OFF	1280	1024	ON
	1280x960	991	72	1376	pixel	1280	960	OFF	1280	960	ON
	1152x870	898	72	1247	pixel	1152	870	OFF	1152	870	ON
	1024x768	793	72	1101	pixel	1024	768	OFF	1024	768	ON
	832x624	645	72	895	pixel	832	624	OFF	832	624	ON
	800x600	620	72	861	pixel	800	600	OFF	800	600	ON
	640x480	496	72	688	pixel	640	480	OFF	640	480	ON
Document	A4Half	433	72	601	mm	34.94	24.63	OFF	210	148	ON
	A4Quarter	338	72	469	mm	31.56	22.39	OFF	148	105	ON
	A4Eighth	338	72	469	mm	22.39	15.78	OFF	105	74	ON
	LetterHalf	424	72	588	inch	1.45	0.93	OFF	8.5	5.45	ON
	LetterQuarter	338	72	469	inch	1.16	0.91	OFF	5.45	4.25	ON
	LetterEighth	338	72	469	inch	0.91	0.58	OFF	4.25	2.72	ON
FilmRecorder	4K	2836	2400	118	pixel	4096	2731	OFF	4096	2731	ON
	2K	1418	2400	59	pixel	2048	1365	OFF	2048	1365	ON

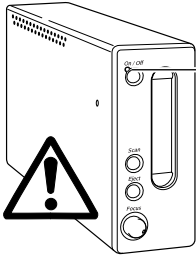

Disconnecting the scanner

Never disconnect the scanner when the indicator lamp is blinking.

Disconnecting the USB cable

Quit the DiIMAGE Scan Utility. Confirm that the scanner indicator lamp is not blinking. Turn the scanner off and then disconnect the cable.

Disconnecting the IEEE cable with 2000 professional, XP, and Macintosh

Quit the DiIMAGE Scan Utility. Confirm that the scanner indicator lamp is not blinking. Turn the scanner off and then disconnect the cable.

Disconnecting the IEEE cable with Windows ME

Shut down the computer and then turn off the scanner; the cable can be disconnected. Never use the unplug-or-eject-hardware routine, otherwise a system error may result.

Minolta History

On February 20th, 1962, John Glenn became the first American to orbit the Earth. On board his Friendship 7 spacecraft was a Minolta Hi-matic camera to record that historic event. The 4 hour, 55 minute, and 23 second flight orbited the Earth three times at an average speed of 28,000 kph (17,500 mph).

Mr. Glenn visited our Sakai camera factory in Japan on May 24th, 1963 to plant a palm tree to celebrate the occasion. The palm tree is still in the courtyard of the factory and stands over eight meters tall (26ft).

The camera? It was not lost. It is on display at the Smithsonian Institution's National Air and Space Museum in Washington D.C. This and other objects from John Glenn's Friendship 7 Mercury flight can be found in gallery 210, "Apollo to the Moon."



Troubleshooting

This section covers minor problems with scanner operation. For major problems or damage, or if a problem continues to reoccur frequently, contact your dealer or a Minolta service facility.

SYMPTOM or MESSAGE	SOLUTION
When starting up the utility software, could-not-confirm-scanner-connection message appears.	Confirm the cable is securely connected between the computer and scanner. Turn the scanner off and on. Click OK to continue.
When starting up the utility software, close-scanner-door message appears.	Close the scanner door (p. 22). Click OK to continue.
<ul style="list-style-type: none"> • The utility software freezes. • The scanning time increases. 	Turn off the scanner. Shut down the image-processing application and increase its memory allocation. Restart the computer and scanner.
Unusual image color when scanning color negative film.	Confirm color negative film is selected in the main window, and rescan the image, or color balance the image using the DiIMAGE Scan's image-processing tools. If the problem is not solved, reinstall the DiIMAGE Scan Utility.
The scanned image is not sharp.	Select an autofocus option in the preference dialog box, or use point AF or manual focus.
Images not sharp when using the manual focus dial. Slider displayed in the manual focus dialog box.	Turn the manual focus dial function on in the preference dialog box.
The scanner's AF system does not work.	Turn the manual focus dial function off in the preference dialog box.
Cannot-verify-home-position message appears during scanning.	The film holder was hindered during the scan. Turn off the scanner, and restart the computer.
The scanner indicator lamp blinks rapidly.	The scanner door was opened during setup. Close the door, and shut down and restart the scanner and DiIMAGE Scan Utility.
The set-holder message appears.	Reload the holder into the scanner.
The holder-does-not-match-selected-film message appears.	Set the correct film format in the DiIMAGE Scan Utility or insert the correct holder into the scanner.
The insufficient-memory message appears.	Increase the memory requirements for the host application. If multiple images have been scanned, close and relaunch the host application.
The DiIMAGE Scan preview image displays unusual color reproduction.	Remove the film holder and close the scanner door. Press shift+control+I (Windows) or command+control+I (Macintosh) to initialize the scanner.

Checking software installation - Windows

If the scanner was connected to the computer before the DiIMAGE Scan Utility was installed, the computer may not recognize the scanner unit. Use the following instructions to confirm the driver was installed correctly:

1. *Windows 98, 2000, Me*: right click on the My-computer icon. Select “properties” from the drop-down menu.
Windows XP: from the start menu go to the control panel. Click on the performance and maintenance category. Click the system button to open the system properties window.
2. *Windows 2000 and XP*: select the hardware tab in the properties window and click the device-manager button.
Windows 98 and Me: click the device-manager tab in the properties window.
3. The driver file should be located in the imaging-device location of the device manager. Click on the location to display the files. MINOLTA DiIMAGE Scan Elite5400 should be listed as the imaging device.

If the file are not located in the imaging-device location, open the other-devices location of the device manager. If MINOLTA DiIMAGE Scan Elite5400 is listed, use the following instructions to delete the driver:

1. Click on the driver to select it for deletion.
2. *Windows 2000 and XP*: click on the action button to display the drop-down menu. Select uninstall. A confirmation screen will appear. Clicking the yes button will remove the driver from the system.
Windows 98 and Me: click the remove button. A confirmation screen will appear. Clicking the yes button will remove the driver from the system.
3. Restart the computer. Confirm the driver is in the proper location using the instructions at the top of the page.

When the scanner is initially connected to a computer with a Windows 98, 98SE, or 2000 Professional operating system, the found-new-hardware wizard will appear briefly. No action is required. With Windows 2000, the “Digital Signature Not Found...” message may appear. Click the yes button to complete the scanner installation.

When the scanner is initially connected to a computer with a Windows XP operating system, the found-new-hardware wizard will appear. Click the next button. The “not passed Windows Logo testing” message appears. Click the continue-anyway button to complete the scanner installation.

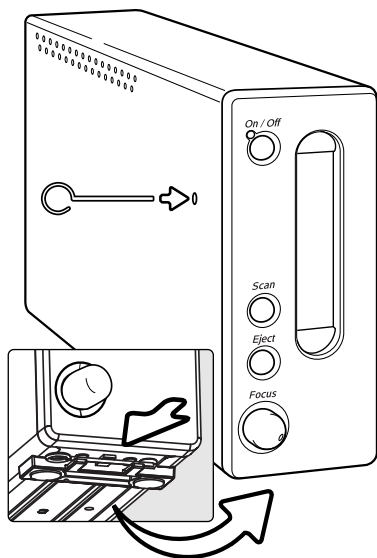

Closing the scanner door

The front door closes automatically when the film holder is removed. The door must be closed for the scanner to initialize.

If the door does not close automatically, it can be closed manually with the supplied reset tool. Insert the tool into the hole on the side of the scanner until the latch releases the door. Do not force the tool into the scanner.

The reset tool can be stored in a special clip on the front feet on the bottom of the scanner unit. Slide the tool between the front and back retaining clips, see illustration.

Technical support

Please contact your dealer for information regarding installation, USB or IEEE 1394 interface recommendations, or application compatibility. If your dealer is unable to help you, contact an authorized Minolta service facility. Please have the following information ready when calling Minolta technical support:

1. The name and model of your computer and operating system.
2. The available application RAM and hard disk space.
3. Other connected USB, IEEE 1394, or FireWire devices.
4. DiMAGE Scan Utility version number. The version number is displayed by placing the mouse pointer on the status bar in the main window.
5. A description of the problem.
6. Any message that appears on the screen when the problem occurs.
7. The frequency of occurrence.

Warranty and product registration

Please take the time to fill in the warranty and product registration card. Technical support, scanner software upgrades, and product information is available when the product is registered.

Technical specifications

Scan type:	Moving film, fixed sensor, single-pass scan
Film type:	Negative and positive, color and monochrome
Film formats:	Mounted and unmounted 35mm film.
Scanning dimensions:	24.61 x 36.69mm (5232 x 7800 pixels)
Optical input resolution:	5400 dpi
Image sensor:	3-line primary-color CCD with 5300 pixels/line
A/D conversion:	16 bit
Color depth:	8 bit and 16 bit per color channel
Dynamic range:	4.8
Light source:	Cold cathode fluorescent tube
Focusing:	Autofocus, point AF, and manual focus
Interface:	IEEE1394 and USB 2.0 (USB 1.1 compatible)
Power consumption:	Max. 30 W
Dimensions (W x H x D):	65 x 165 x 360 mm 2.6 x 6.5 x 14.0 in
Weight (approx.):	2.5 kg / 5.5 lb
Operating environment:	10° - 35°C (50° - 95°F), 15-80% humidity without condensation
Storage environment:	-20° - 60°C (-4° - 140°F), 15-80% humidity without condensation

Scan times (approx.):		USB 2.0*	IEEE1394*	FireWire**
	Index scan	15 sec.	15 sec.	16 sec.
	Prescan	10 sec.	10 sec.	12 sec.
	Scan	60 sec.	68 sec.	69 sec.

Scanning time changes according to the preferences used. Scanning time can be longer for negative film than positive film.

Test conditions: Slide Mount Holder SH-M10, Color positive film, no autoexposure, no image correction, 5400dpi 8-bit scan.

*Windows: Pentium IV 2.53 GHz, Windows XP Professional, 1 GB RAM, 60.9 GB hard disk space, built-in USB port, Melco IFC-ILP4 IEEE interface, Adobe Photoshop ver. 7.0.1.

**Macintosh: PowerPC G4 1 GHz, Mac OS X 10.2.1, 1 GB RAM, 70.7 GB hard disk space, Apple FireWire port, Adobe Photoshop ver. 7.0.1.

Specifications are based on the latest information available at the time of printing and are subject to change without notice.



We offer support for our digital products 24 hours per day on
www.minoltasupport.com.

Camera know-how, image composition, digital image editing:
discover more about Minolta's new internet world and visit
www.minoltaphotoworld.com

© 2003 Minolta Co., Ltd. under the Berne Convention
and the Universal Copyright Convention.

0-43325-53204-7

9222-2890-11 AV-A304/ME200304
Printed in Germany