

Dimâge Scan Speed



MINOLTA

Thank you for purchasing the Minolta Dimâge Scan Speed. The Dimâge Scan Speed is a dual format film scanner capable of scanning 35mm and, with the optional AD-10 APS Adapter, Advanced Photo System film.

This manual has been designed to help you understand the operation of your scanner. Please read this manual thoroughly to realize all the benefits of your scanner.

The instructions in this manual assume you have a working knowledge of the operating system for your computer (Macintosh OS, Windows 95, Windows 98, or Windows NT) and its conventions. Familiarity with the mouse and standard operating system menus and commands is necessary before operating the driver software for the Dimâge Scan Speed.

This manual does not instruct in the:

- basic use of personal computers.
- use of Windows 95, Windows 98, Windows NT, or Macintosh OS.
- use of Adobe Photoshop, Paint Shop Pro, or Corel Draw.

The examples in this manual use Windows 95. The appearance of some screens may differ from the examples when using Windows 98, Windows NT, or the Macintosh operating system.

Microsoft, Windows[®], Windows 95[®], Windows 98[®], and Windows NT[®] are registered trademarks of the Microsoft Corporation.

Macintosh[™], Apple[®], and Power Macintosh[®] are registered trademarks of Apple Computer, Inc. Adobe[®] and Photoshop[™] are registered trademarks of Adobe Systems Incorporated.

Corel Draw[™] is a trademark of the Corel Corporation.

Paint Shop Pro is the copyright of Met's Corporation.

Other corporate and product names are the trademarks and registered trademarks of their respective companies.

- Changes or modifications not approved by the party responsible for compliance could void the user's authority to operate the equipment.
- This manual may not be copied in part or whole without prior written permission from Minolta Co., Ltd. ©1997 Minolta Co., Ltd.
- Every necessary caution has been taken to ensure the accuracy of this instruction manual. Please contact us if you have any questions, find any errors, or notice missing information.
- Minolta is not responsible for loss, damage, or other results occurring during the operation of this product.



This mark certifies that this product meets the requirements of the EU (European Union) concerning interference causing equipment regulations. CE stands for Conformité Européenne.

Film Scanner: Dimâge Scan Speed



Tested to comply with FCC standards.

FOR HOME OR OFFICE USE

This device complies with Part 15 of the FCC Rules. Operation is subject to the following conditions: (1) This device may not cause harmful interference, and (2) this device must accept any interference received, including interference that may cause undesired operation. To meet FCC regulations, the SCSI cables used with this scanner must be equipped with ferrite cores.

This Class B digital apparatus complies with Canadian ICES-0003..

Cet appareil numérique de la classe B est conforme à la norm NMB-003 du Canada.

Tested by the Minolta Corporation 101 Williams Drive Ramsey, New Jersey 07446 USA

FOR PROPER AND SAFE USE

Please read and understand each caution before using this product.

CAUTION

To avoid fire or electric shock:

- Only use the voltage specified for this unit.
- Do not expose this unit to liquids.
- Do not insert metal objects into this unit.
- Do not touch the cord or plug if your hands are wet.
- Unplug this unit when it is not in use.

Improper use of the power cord may result in fire or electric shock.

- Insert the plug securely into an electrical outlet.
- Do not pull on the cord. Grasp the plug when removing the power cord from an outlet.
- Do not scratch, twist, modify, heat, or place a heavy object on the power cord.
- Do not connect the ground to a gas pipe, telephone ground, or a water pipe. Improper grounding can result in electric shock.



This product must have sufficient ventilation while in use. Blocked ventilation ducts may cause the unit to overheat, increasing the risk of fire.

- Do not use or store this product in dusty or very humid areas.

If there is smoke, a strange smell, or any other unusual conditions, shut down and unplug the unit, then contact a Minolta Service Facility.

Do not attempt to disassemble this product. It contains high-voltage circuits. Take the product to a Minolta Service facility for repairs.



Unexpected damage may occur if this unit is left unattended near young children.

SYSTEM REQUIREMENTS – PC / AT

CPU: IBM PC/AT compatible with an i486DX-2 66MHz processor or better. An Intel Pentium or later when Windows NT 4.0 is installed.

- Support cannot be provided for custom or home built machines.

Operating System: Windows 95 (incl. OSR2), Windows 98, or Windows NT 4.0.

Memory: A minimum of 32 MB RAM.

Hard Disk Space: 90 MB of available hard disk space.

SCSI Board: The following Adaptec SCSI boards are recommended for this device:

AVA-1505AE	AHA-1520B	AHA-1540CP
AHA-2940J	AHA-2940U	AHA-2940AU
AHA-2940W	AHA-2940UW	AHA-2910B

- The AHA-2940N SCSI board has been test and approved for use on NEC PC-9821 series machines.
- Do not use AVA-1505AE, AHA-1520B, and AHA-1540CP SCSI boards with NEC PC98NX Series machines.
- Support will not be provided for malfunctions or problems caused by the use of untested SCSI boards.

Monitor: SVGA (800 x 600) or better. VGA can be used.

Other: TWAIN driver is compatible with Photoshop ver. 3.05 and 4.0.1, Paint Shop Pro 4.1E, Corel Draw 7, Corel Draw 8.

SYSTEM REQUIREMENTS – MACINTOSH

CPU: Power PC

Operating System: Mac OS 7.1 – 8.1

Memory: A minimum of 8 MB application RAM in addition to the requirements for the Mac OS and Adobe Photoshop™

Hard Disk Space: 90 MB of available hard disk space.

Monitor: 13 inch monitor capable of displaying 32,000 colours.

Other: Plug-in is compatible with Photoshop ver. 3.05 or newer.
ColorSync profile is compatible with ColorSync ver. 3.0.
Turn off Virtual Memory and the Modern Memory Manager.

PACKAGE CONTENTS

The following contents should be included in this package.

1. Minolta Dimâge Scan Speed
2. 35mm Slide and Negative holders
3. SCSI cable SC-11
4. AC power cord
5. DS_Speed driver CD ROM
6. Instruction Manual
7. Warranty card
8. Photoshop 4.0 LE CD ROM

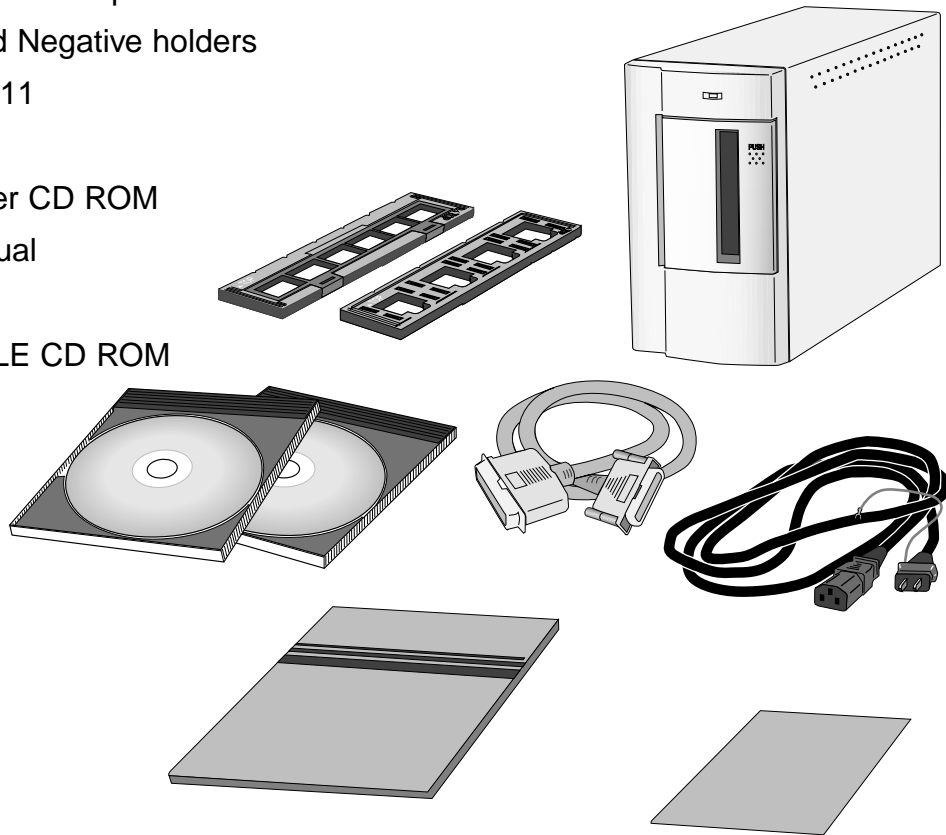

Software Registration

Please register this software before using it...

Once registered, you will receive technical support, software upgrade and product information. Complete and return the enclosed Product & Software Registration form after detaching it from the Warranty. No postage is necessary.

- The information you provide is confidential and will only be used by Minolta Customer Service and Product Research & Development.

TABLE OF CONTENTS

FOR PROPER AND SAFE USE	1
SYSTEM REQUIREMENTS PC/AT	2
SYSTEM REQUIREMENTS Macintosh	3
PACKAGE CONTENTS	4
TABLE OF CONTENTS	5
NAMES OF PARTS	6
SCANNER SETUP	
Setting the SCSI ID	8
Connecting the Hardware	9
Installing the Software PC/AT	12
Installing the Software Macintosh	15
STANDARD OPERATION	
Launching the Software	18
<i>Command Window - Names of Parts</i>	20
<i>Prescan Window - Names of Parts</i>	21
Setting the Preferences	22
Loading the Film Holder	23
Inserting the Film Holder into the Scanner	25
Setting the Film Type	26
Prescan	26
Auto-Exposure Lock	27
Orienting the Image	28
Image Correction	32
<i>Variations Dialog Box - Names of Parts</i>	33
Image Correction - Variations	34
<i>Histogram Dialog Box - Names of Parts</i>	35
Image Correction - Histogram	36
<i>Tone Curves Dialog Box - Names of Parts</i>	40
Image Correction - Tone Curves	41
Job Type	44
Final Scan	46
SCANNING APS FILM	
Launch Software	48
Specify Film Type	48
<i>Index Window - Names of Parts</i>	48
Preferences - APS Settings	49
<i>APS Adapter - Names of Parts</i>	50
Loading the APS Adapter	50
Inserting the APS Adapter into the Scanner	51
Index Scan	52
Prescan and Image Correction	54
Scanning the Image	55
Removing the APS Adapter	56
APPENDIX	
Scan Settings	58
<i>Scan Settings Dialog Box - Names of Parts</i>	58
Creating/Deleting Job Files	60
Job File List	61
Glossary	64
ColorSync	66
Trouble Shooting	67
Specifications	68
User Technical Support	69

SCANNER – NAMES OF PARTS

1. Indicator lamp
2. Film slot
3. Film door
4. Power switch
5. SCSI port - DB25
6. Terminator power switch
7. SCSI ID switches
8. SCSI port - SCSI-1
9. AC socket

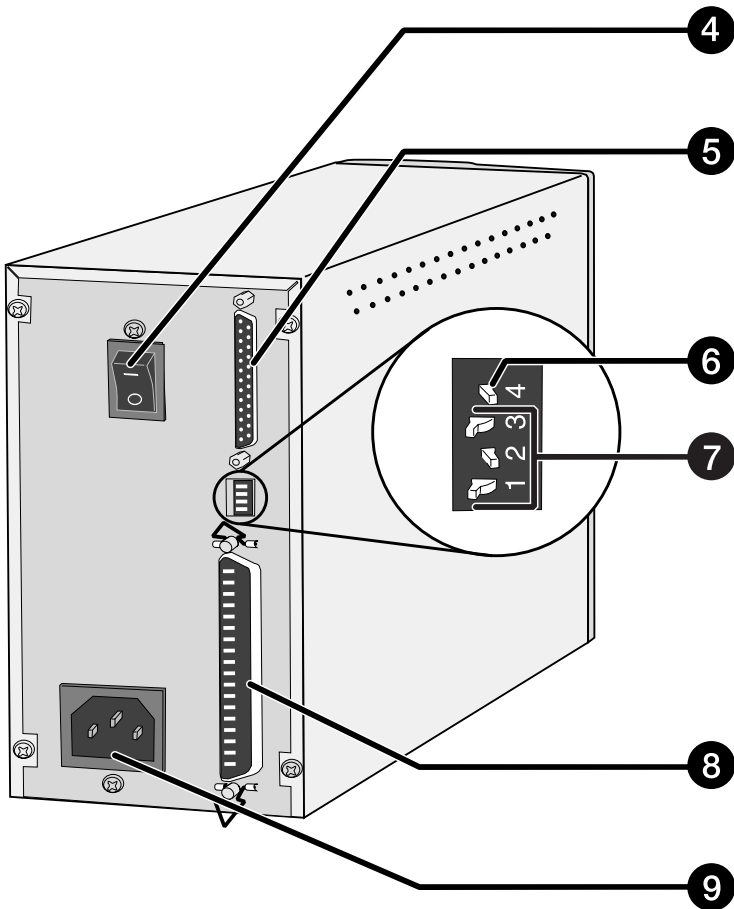
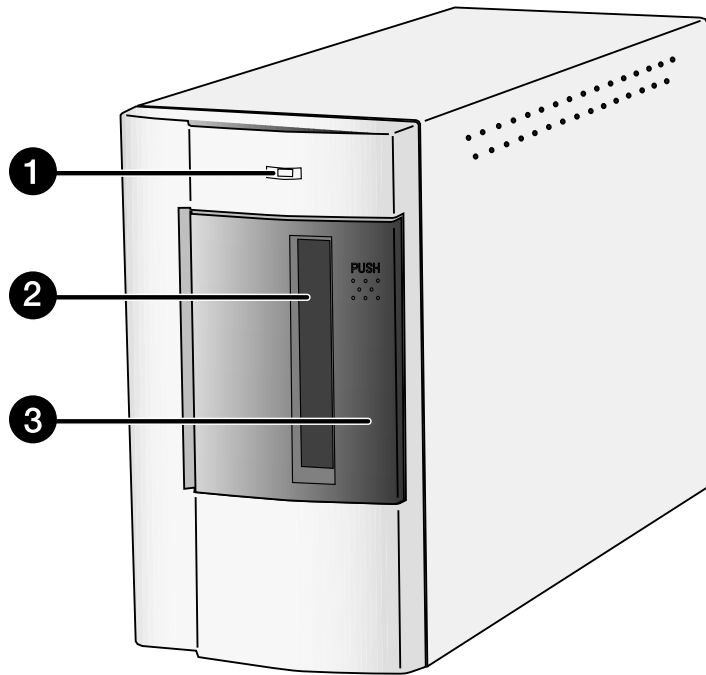

SCANNER SETUP

SETTING THE SCSI ID

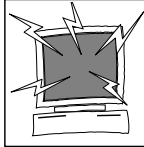

Turn off the computer and all the devices in the SCSI chain before changing SCSI IDs, connecting, or disconnecting SCSI cables. Hardware damage may occur if this precaution is not followed.

A SCSI ID is a unique address you assign to each SCSI device connected to your computer. The SCSI ID range of your computer is from 0 to 7, however some ID's are already occupied.

	Occupied SCSI ID
IBM PC/AT	7 - SCSI host adapter
Macintosh	0 - internal hard drive* 3 - internal CD ROM drive** 7 - operating system

* IDE Macintosh systems do not use SCSI ID 0 for the hard drive.

** SCSI ID 3 is available on the external bus on Macintosh systems with a dual bus.

Setting the SCSI ID

1. Turn off the computer and all connected SCSI devices.
2. Determine which SCSI IDs are not being used.
3. Using a pointed object, set the switches to an unused SCSI ID.

- The Dimâge Scan Speed's SCSI ID is factory preset to 5. If 5 is not occupied, there is no need to change the SCSI ID.
- Two operating SCSI devices in the same SCSI chain cannot share a SCSI ID.

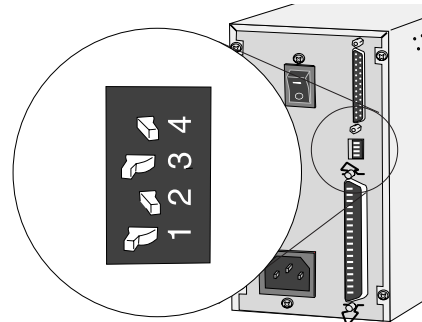

SCSI ID Dip Switch Settings

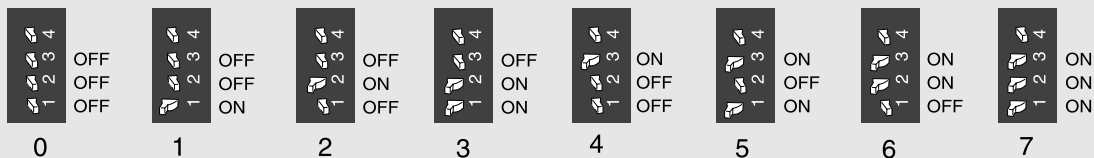

CONNECTING THE HARDWARE

Connecting the SCSI Cable

This scanner has been packaged with the SCSI cable SC-11 (DB25-to-SCSI-1). See your dealer if you require a different SCSI cable.

- To meet FCC regulations, the SCSI cables used with this scanner must be equipped with ferrite cores.

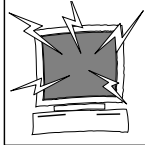

**BEFORE YOU BEGIN...
TURN THE COMPUTER AND ALL CONNECTED
DEVICES OFF.**

1. Place the scanner on a level surface.
2. Connect one end of the SCSI cable to either SCSI port on the back of the scanner

- Either SCSI port can be used for other configurations, there is no dedicated in or out port.

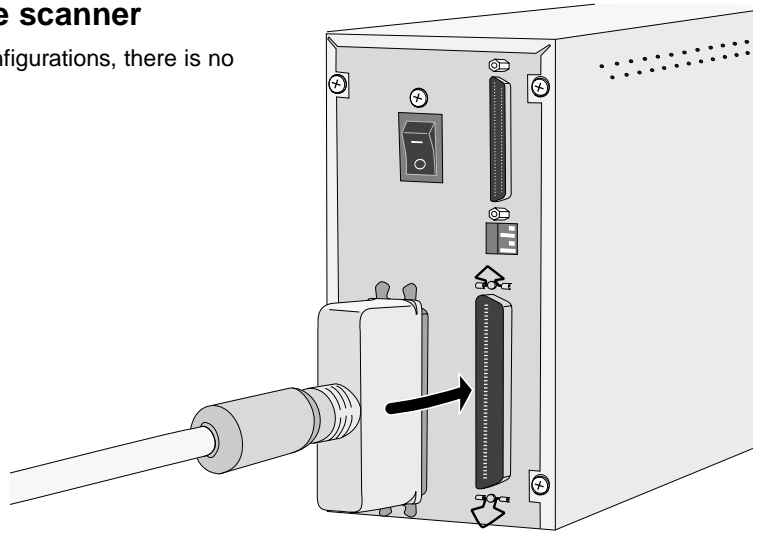

3. Connect the other end of the SCSI cable to the SCSI port on the computer or the last device in the SCSI chain.

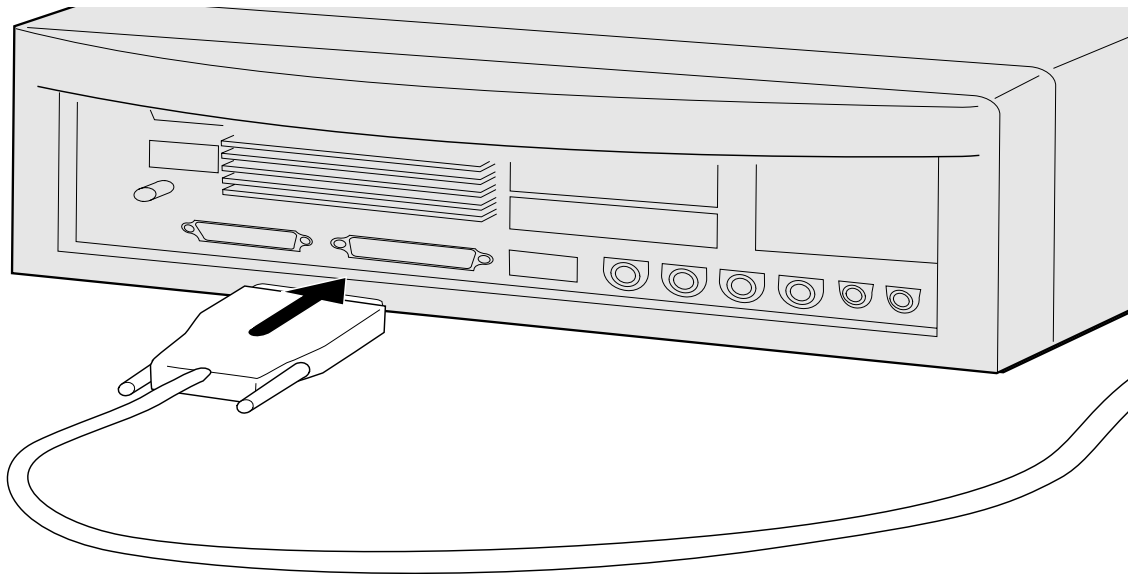

Continued on the following page.

CONNECTING THE HARDWARE

If there are other devices in your SCSI chain...

4. Plug the SCSI cable from the next device into the open port on the back of the scanner.

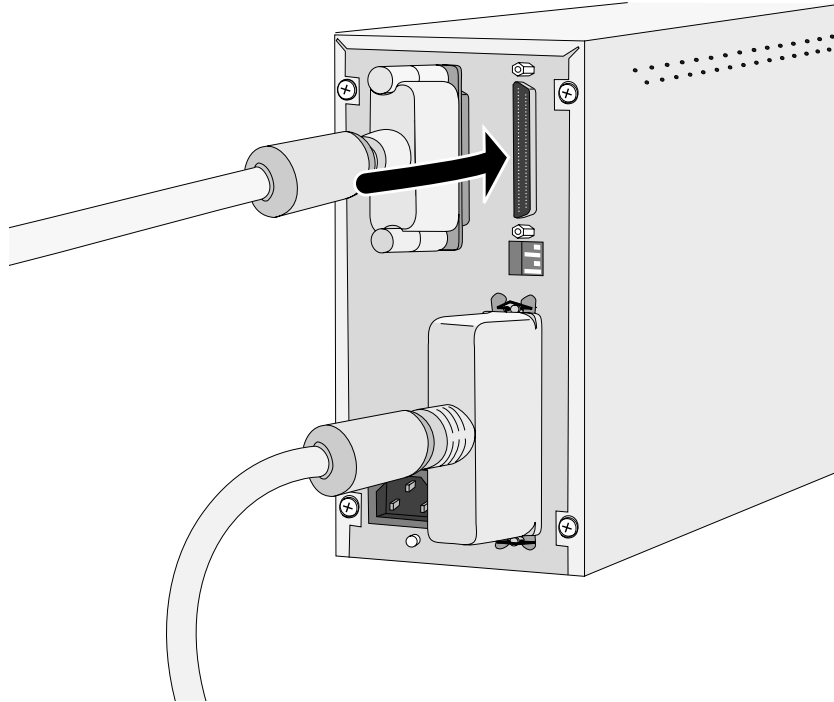

5. Plug the power cord into the scanner's AC socket, then plug it into a grounded outlet.

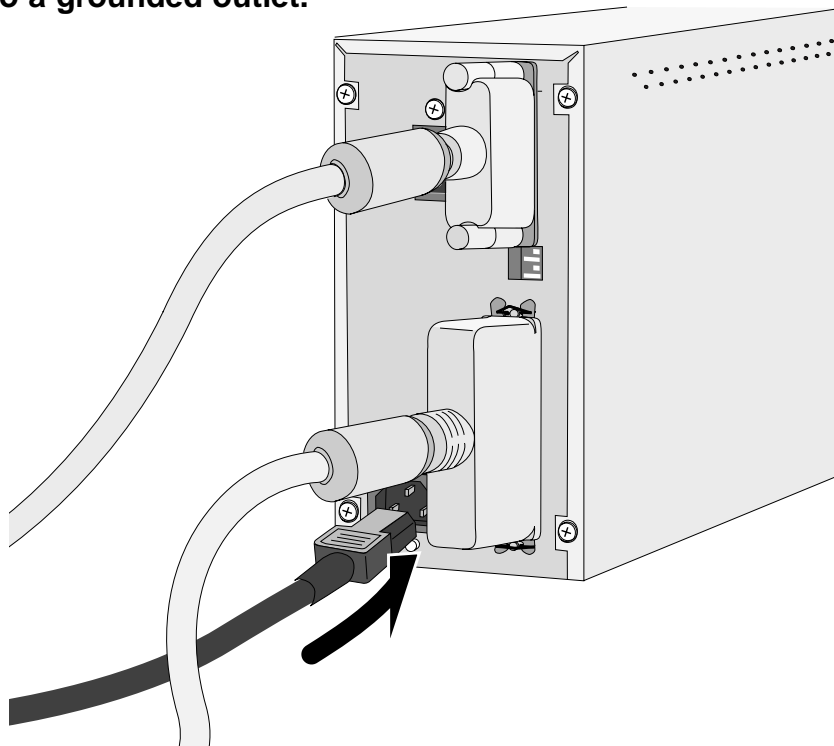

CONNECTING THE HARDWARE

If the Dimâge Scan Speed is the last or only device in your SCSI chain...

4. Turn the terminator power switch (switch 4) to ON.

- An external terminator is not necessary with this scanner.

NOTE:
Terminating the SCSI chain helps to suppress electronic noise in the SCSI chain. Not terminating the SCSI chain can cause slowdowns, data errors, crashes, and other unpredictable errors.

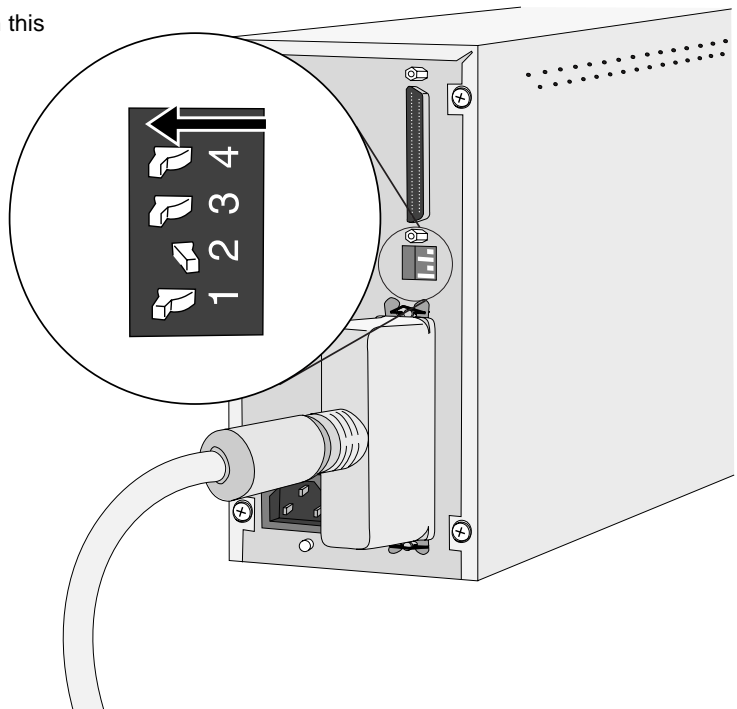

5. Plug the power cord into the scanner's AC socket, then plug it into a grounded outlet.

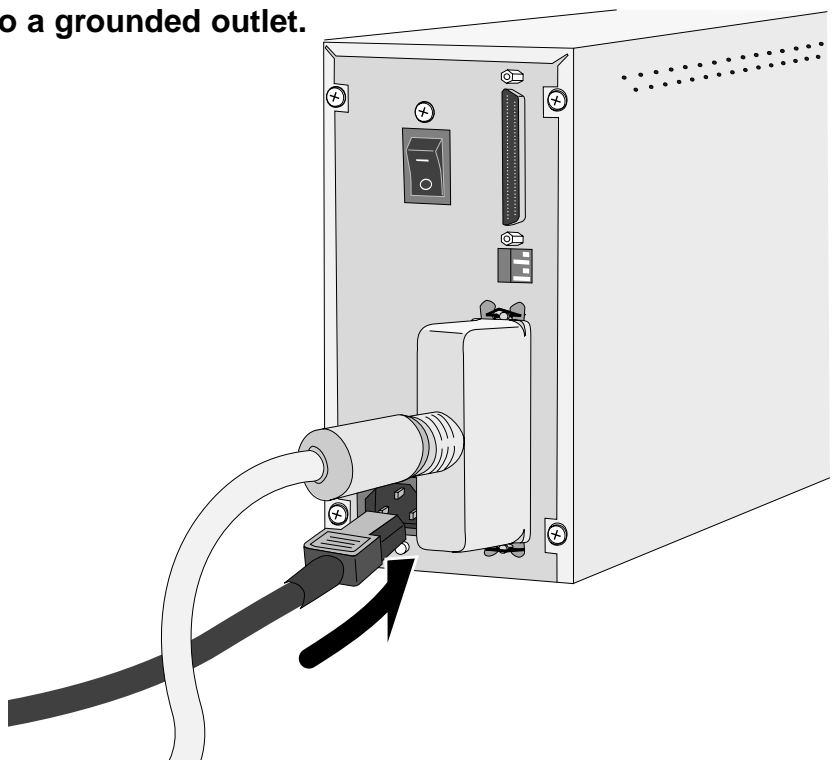

INSTALLING THE SOFTWARE – PC/AT

WINDOWS 95/ WINDOWS 98 / WINDOWS NT

Dimâge Scan Speed for Windows Setup installs the Twain and Twain_32 driver software into the drive and folder you select.

- The appearance and/or wording of some dialog boxes may vary depending on the version of Windows running on your machine.
- These installation instructions assume drive D is the CD-ROM drive.

1. Turn on the scanner, then turn on the PC.
2. Start the Windows operating system.

This step varies with your specific operating software...

Windows 95

- The New Hardware Found dialog box will appear.



3. Click on Cancel.

- This dialog box may appear several times. Repeat step 3 until the dialog box no longer appears.

Windows NT

3. Select Start > Settings > Control Panel, then double-click on the SCSI Adapters icon. Confirm that Minolta #2884 appears as a connected device for your SCSI board.

- If Minolta #2884 does not appear, turn the system off and check all the connections. Repeat the procedure.

Windows 95 Release 2 (OSR2) and Windows 98

- The Device Wizard dialog box will appear.



3. Click on Next until the Unknown Device window appears...

then click on Finish.

- This dialog box may appear several times. Repeat step 3 until the dialog box no longer appears.

4. Insert the Dimâge Scan Speed CD-ROM into the CD-ROM drive.

INSTALLING THE SOFTWARE – PC/AT

5. Select **R**un form the Start menu.

The Run dialog box will appear

6. Select **D:\ENGLISH\Setup.exe** from the Open drop-down list, then click on **OK**.

- If your CD-ROM drive is not the D drive, replace the D with the appropriate designation for your CD-ROM drive.

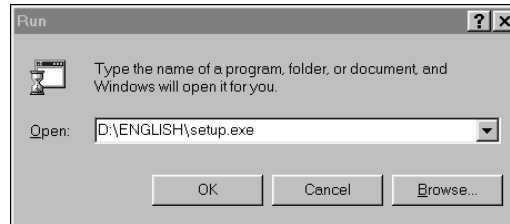

The installer flash will appear.

7. Click on **N**ext



The Software License Agreement will appear.

8. After reading the agreement, click on **Y**es.

- If you do not agree to the conditions stated in the End-User License Agreement, click on **N**o and the software will not be installed.

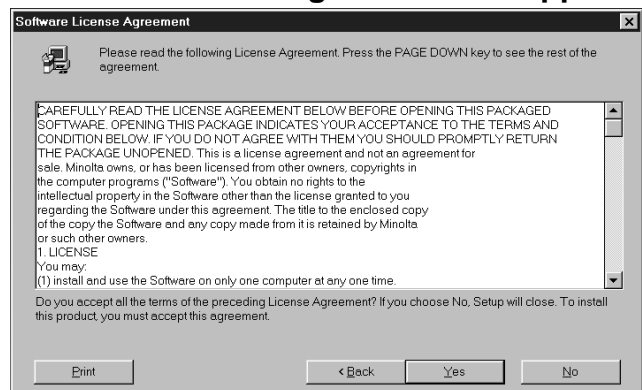

The Choose Destination Location dialog box will appear

9. Click on **B**rowse to select another destination directory...

- An install directory and path can also be entered directly into the install path list box.

then click on **N**ext

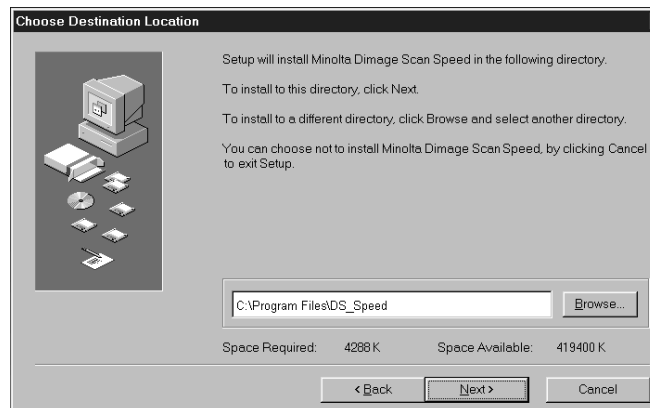

Continued on the following page.

INSTALLING THE SOFTWARE – PC/AT

The Setup Type dialog box will appear

10. Choose either **Typical** or **TWAIN Files** install, then click on **Next**.

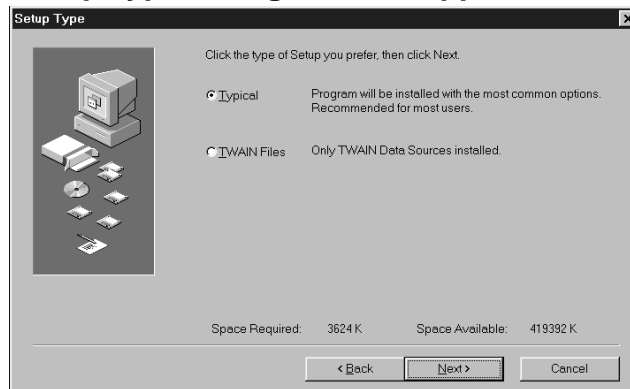

The Select Program Folder dialog box will appear.

11. Click on **Next**.
- Setup will begin

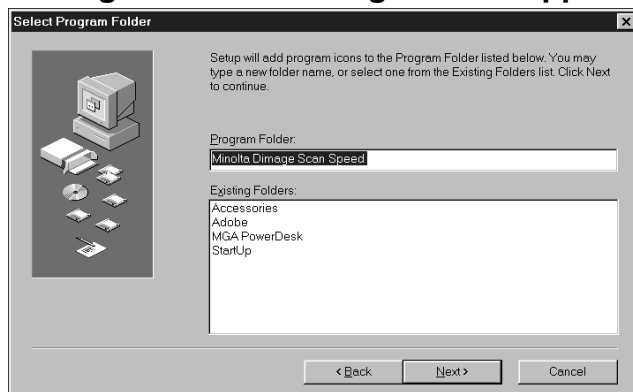

The Setup Successful dialog box will appear.

12. Click on **Close**

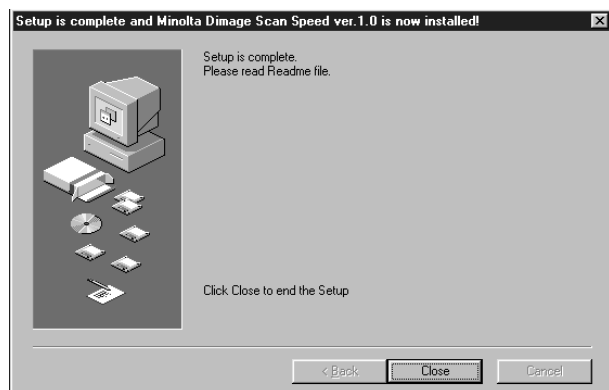

The following dialog box will appear.

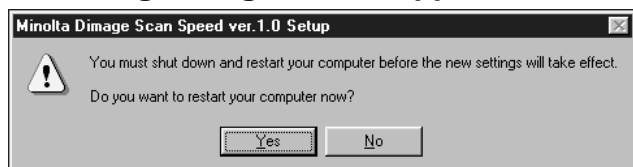

13. Click on **Yes**.



INSTALLING THE SOFTWARE – MACINTOSH



Please remove or disable any antivirus system extensions before launching this installer. These extensions may conflict with the operation of this installer. Replace or re-enable them when installation is complete. Hold the shift key down during startup to disable the extensions.

1. Turn on the Dimâge Scan Speed, then turn on your Macintosh.
2. Quit any open applications.
3. Insert the Dimâge Scan Speed CD-ROM into the CD-ROM drive.
 -  will appear on the desktop.
4. Double-click on .
- The language folders will appear.
5. Open the English language folder, then double click on the Dimage Scan Speed Installer.

6. Click on .

The installer's start-up screen will appear.



7. Click on .

- If you do not agree to the conditions stated in the End-User License Agreement, click on Decline and the software will not be installed.

The End-User License Agreement will appear.

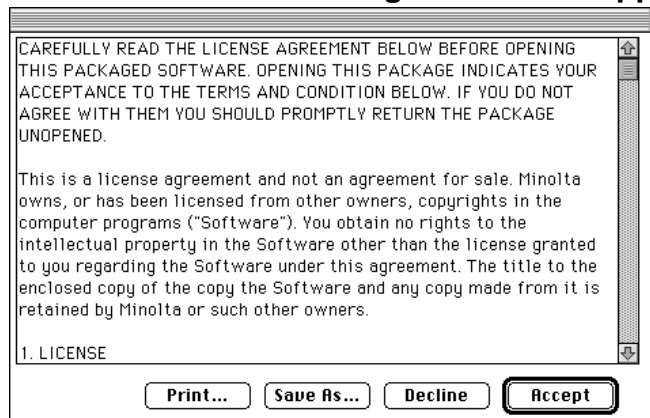

Continued on the following page.

INSTALLING THE SOFTWARE – MACINTOSH

The following dialog box will appear.

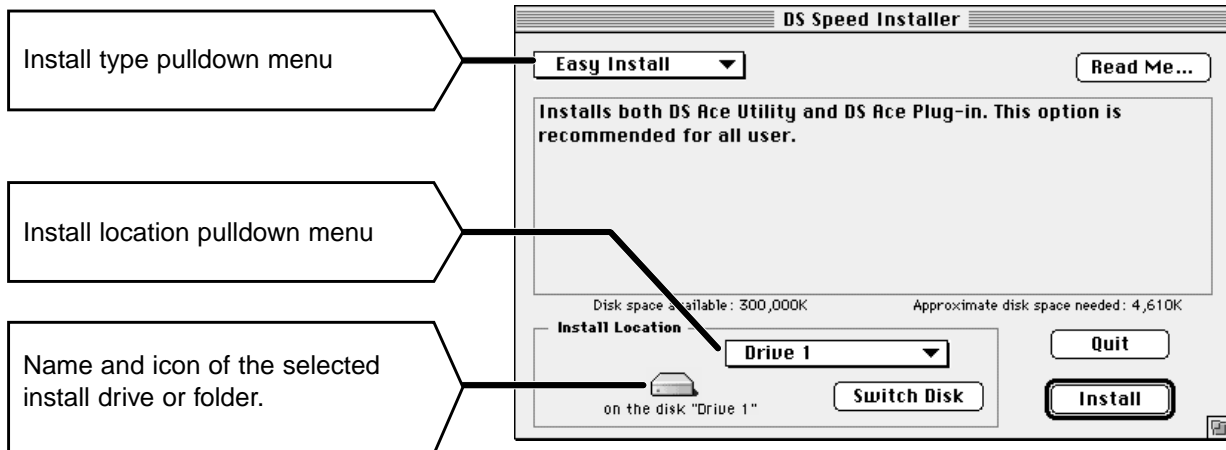

8. Select the install drive (or folder) and type from the pulldown menus.

- You can also click on **Switch Disk** to select an install drive.

9. Click on **Install**.

The following message appears when the installer is finished.

11. Click on **Quit**.

- The software will be installed in a new folder titled Dimage Scan Speed.
- If Easy Install was chosen, the Dimage Scan Speed folder will contain the following items: DS_Speed Utility, DS_Speed Plug-in, and Read Me file.

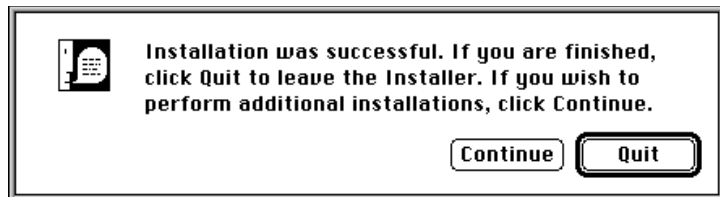

11. Drag the DS Speed Plug-in to the Import/Export folder in the Adobe Photoshop Plug-ins folder.

STANDARD OPERATION

SCAN FLOW

Launch the Software

Set the Preferences

Load the Film Holder

Insert the Film Holder

Specify the Film Type

Prescan

Orient the Image

Correct the Brightness,
Contrast, and Colour

Specify the Job Type

Scan

Save

LAUNCHING THE SOFTWARE

The TWAIN driver lets you control the software through another application, such as your image editing software.

Launching the TWAIN Driver — Windows

This manual uses Adobe Photoshop 4.0.1 as the host application. Commands may vary among applications.

1. Open the host application.
2. Select **File > Import > Select TWAIN_32 Source...**

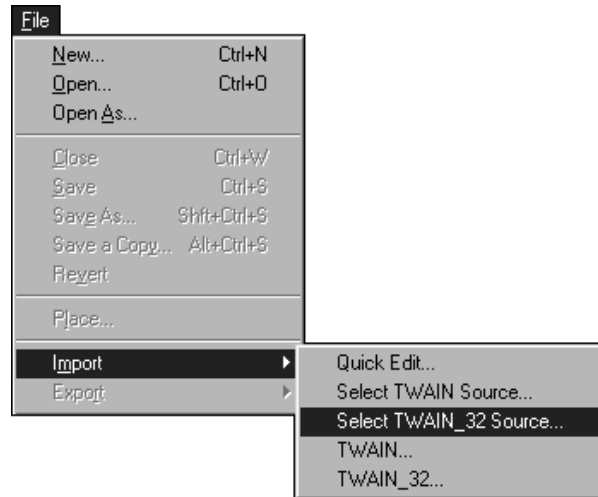

The Select Source dialog box appears.

3. Select **DS_Speed**, then click on **Select**.

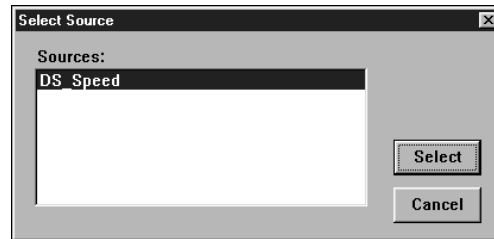

4. Select **File > Import > TWAIN_32**.

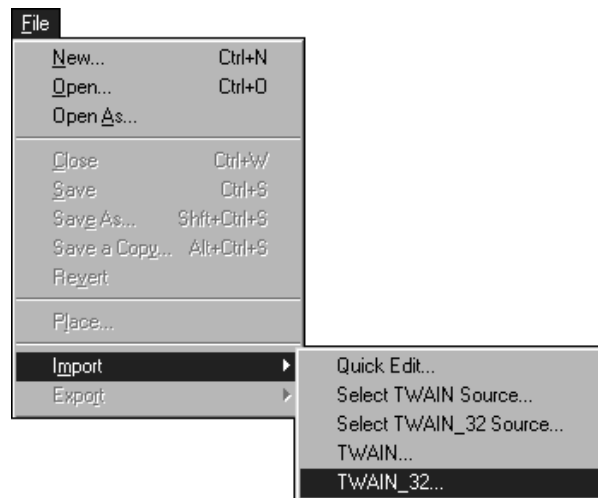

The software is ready for use when the Command window appears (p.20).

LAUNCHING THE SOFTWARE

The plug-in software lets you access the software through Adobe Photoshop.

Launching the Plug-in — Macintosh

1. Launch Adobe Photoshop.
2. Photoshop 4.0.1 and newer:
Select File > Import > DS_Speed Plug-in.

Photoshop 3.0.5:
Select File > Acquire > DS_Speed Plug-in

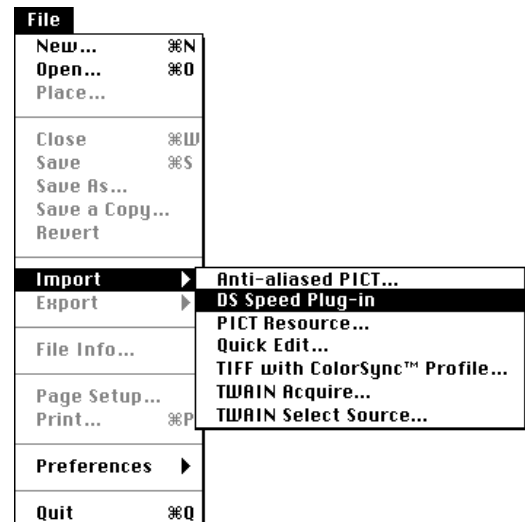

The software is ready for use when the Command window appears (p.20).

Launching the Utility Software

Windows

Select Start > Programs > Minolta Dimage Scan Speed > DS Speed Utility

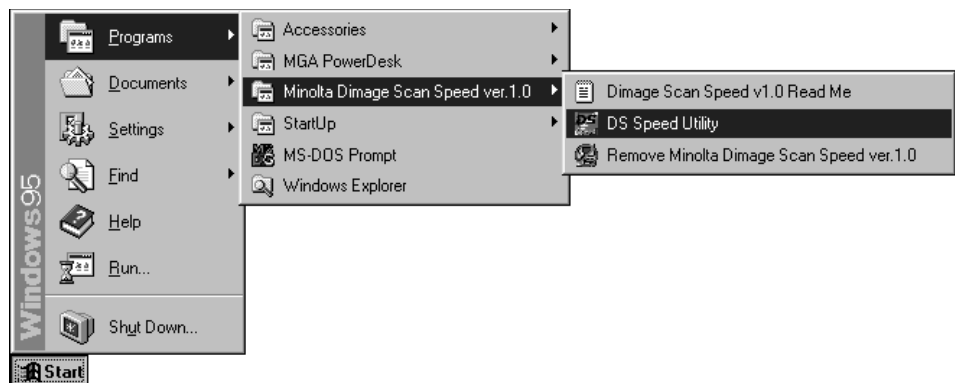

Macintosh

Double click on .

The software is ready for use when the Command window appears (p.20).

COMMAND WINDOW – NAMES OF PARTS

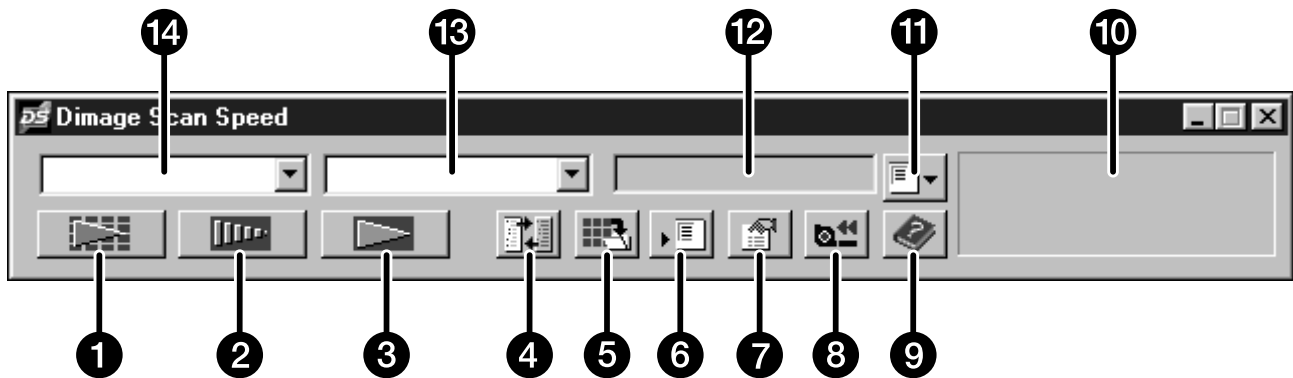

- | | |
|---------------------------------|----------------------------------|
| ❶ Index Scan button (APS p. 52) | ❸ Rewind button (APS p. 56) |
| ❷ Prescan button | ❹ Help button (⌘? on Macintosh) |
| ❸ Scan button | ❺ Status bar |
| ❹ Scan Settings button | ❻ Load Job button |
| ❺ Save Index Scan button | ❼ Displays current Job selection |
| ❻ Save Job button | ❽ Film Type list box |
| ❼ Preferences button | ❾ Film Format list box |

PRESCAN WINDOW – NAMES OF PARTS

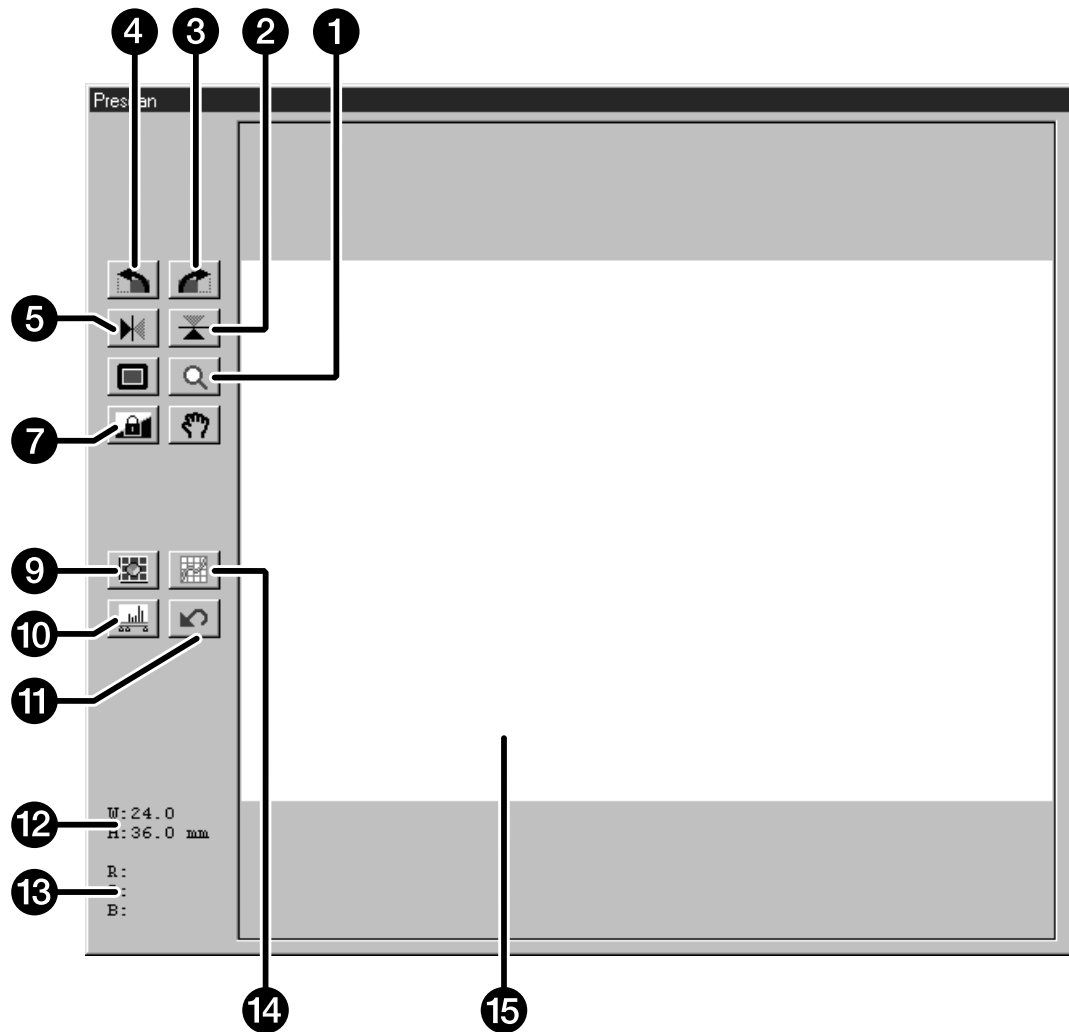

- ① Zoom button
- ② Flip Vertical button
- ③ Rotate Right button
- ④ Rotate Left button
- ⑤ Flip Horizontal button
- ⑥ Full-Screen View button
- ⑦ AEL button
- ⑧ Grab button
- ⑨ Variations button
- ⑩ Histogram button
- ⑪ Reset All button
- ⑫ Cropping frame dimensions
- ⑬ RGB/CMY display
- ⑭ Tone Curves button
- ⑮ Image area

SETTING THE PREFERENCES

1. Click on .

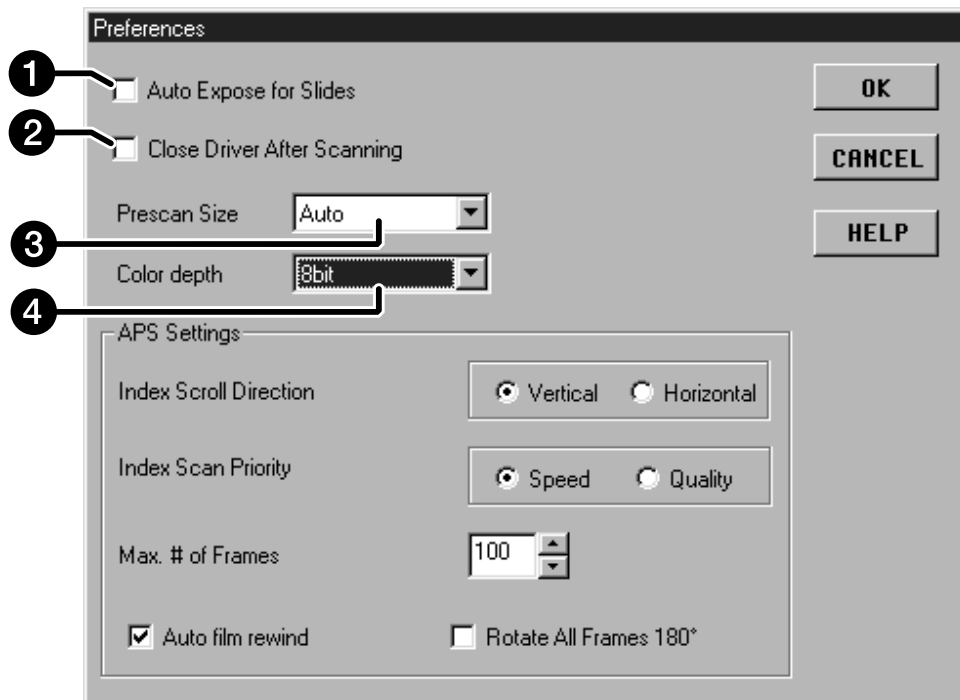

2. Set the preferences as desired.

- 1 **Auto Expose Slides checkbox**

Select this checkbox when scanning underexposed slides.

- 2 **Close Driver After Scanning checkbox**

Closes the scanner's driver software after the scan is complete.

- 3 **Prescan Size list box**

There are three size options for prescan window: Small, Large, and Auto.

- Auto determines the appropriate prescan window size based on the size of your monitor.

- 4 **Colour Depth list box**

The pixel depth of each colour channel used to scan your image (RGB or CMY). Three options are available:

- 8-bit – over 16.7 million colours
- 16-bit – over 2.8 billion colours
- 16-bit linear – same as 16 bit, but image correction is not applied when the image is scanned.

3. Click on  to accept the new preference settings.

- Changes to the Preference settings take effect immediately.

LOADING THE FILM HOLDER

Using the included 35mm negative and slide holders, the Minolta Dimâge Scan Speed can scan mounted or unmounted...

- 35mm colour negatives
- 35mm black & white negatives
- 35mm colour slides
- 35mm black & white positives

Advanced Photo System negatives and slides can also be scanned using the optional AD-10 APS Adapter. See page 48.

Loading the Negative Holder

1. Open the film holder.

2. Place the film in the film holder emulsion side down.

- The film holder will accept film strips up to 6 frames long.
- Brush dust off the film before placing it into the film holder.

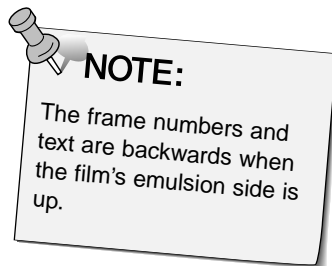
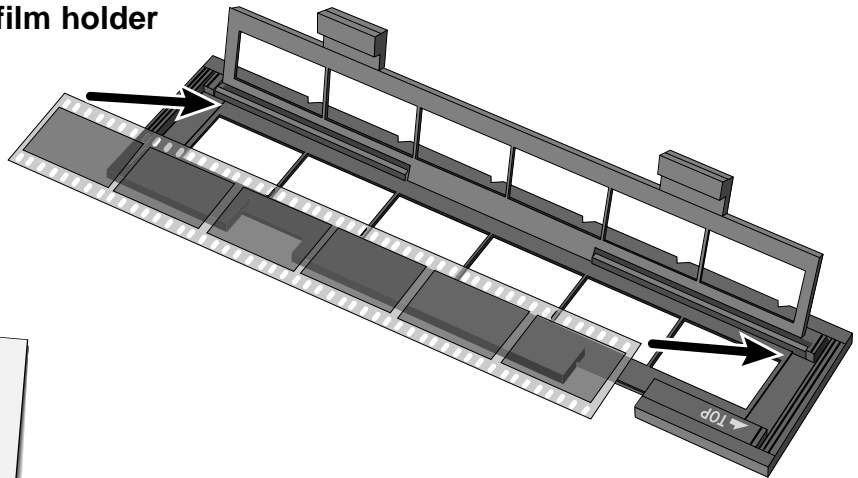

3. Align the frames within the scanning windows.

4. Snap the film holder closed.

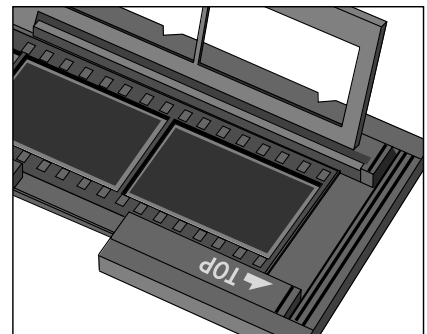

Continued on the following page.

LOADING THE FILM HOLDER

Loading the Slide Holder

1. Insert slides into the slide holder emulsion side down.

- Brush dust off the the slide before placing it into the film holder.
- Slide mounts must be thicker than 1 mm and thinner than 2 mm to fit into the slide holder.
- Orient the slides horizontally, not vertically.

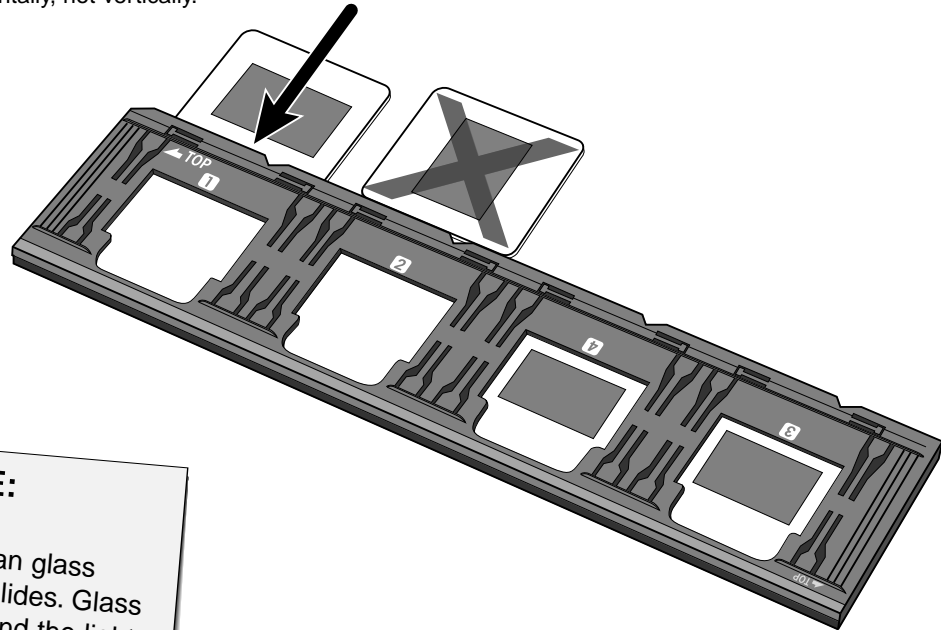

NOTE:
Do not scan glass mounted slides. Glass mounts bend the light from the line scanner, producing bad results.

INSERTING THE FILM HOLDER INTO THE SCANNER

The notches in the film and slide holders identify the position of the scanning windows. Push the holder in all the way in to scan the last frame on that side of the film holder. Remove, flip, then re-insert the film holder to scan the frames on the other side of the holder.

Insert the negative holder into the scanner's film slot to scan frames 1, 2, or 3.

- Frames 1 or 2 with the slide holder.

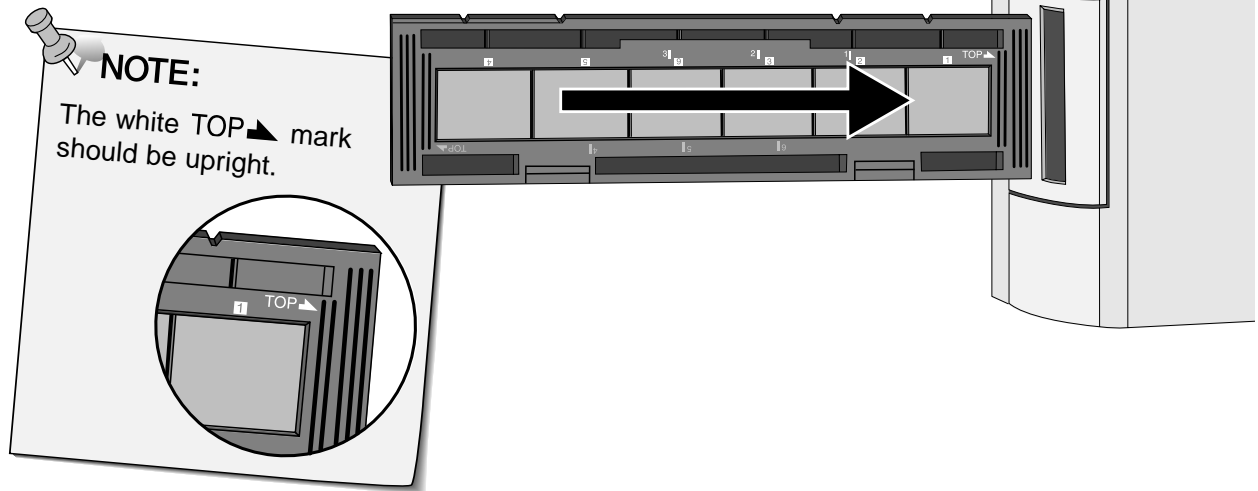

Remove, flip, then re-insert the negative holder to scan frames 4, 5, or 6.

- Frames 3 or 4 with the slide holder.
- The blue TOP mark should be upright

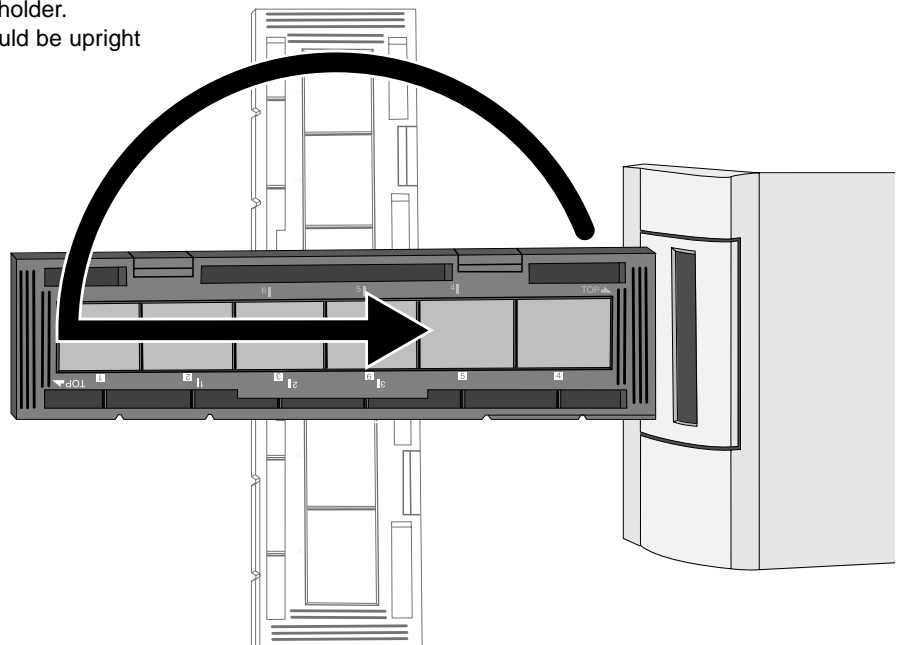

SETTING THE FILM TYPE / PRESCAN

Setting the Film Type

1. Select 35mm from the film format drop-down list.

- The Prescan window appears.

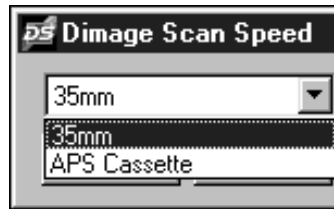

2. Select the film type from the film type drop-down list.

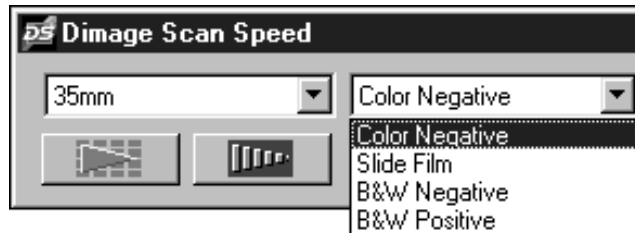

3. Click on  in the Command window.

The prescanned image will appear in the Prescan window.



NOTE:

Press Ctrl when prescanning (⌘ on the Macintosh) to see CMY values in the RGB/CMY display.

AUTO-EXPOSURE LOCK

Especially useful when scanning bracketed exposures, AE lock lets you scan multiple images with the same initial exposure settings. AE Lock saves the automatic exposure settings determined when an image is prescanned. Subsequent images are prescanned using the 'locked' exposure settings.

- AE-lock does not save exposure corrections made in the Variations, Histogram, or Tone Curves dialog boxes.

Setting AE-Lock

After prescanning the image...

1. Click on .

-  can not be selected until an image has been prescanned.

2. Select another image, then click on .

- The scanner skips the setting exposure step in the prescan sequence.

Images will be scanned using the AE lock settings until AE lock is cancelled or the scanner is reinitialized.



Cancelling AE-Lock

1. Click on .

2. Click on  to prescan the image again.

ORIENTING THE IMAGE

Rotate

Click on the  and  buttons to correct the orientation of your image before scanning. Changes will be reflected in the prescan image.

- Click on  to view a full screen display of the area inside the cropping frame.

Click on  to rotate the image 90° clockwise.

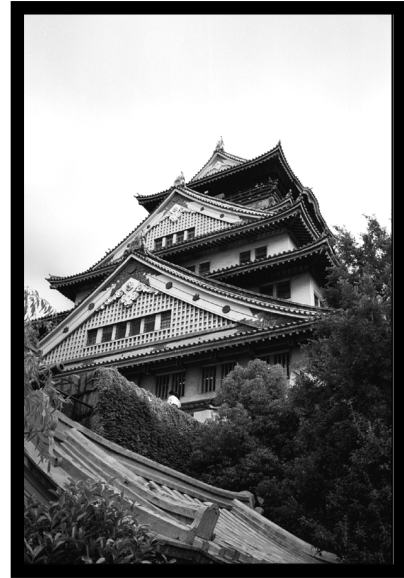

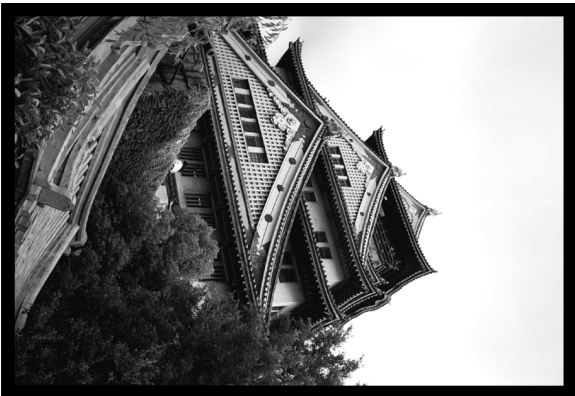

Click on  to rotate the image 90° counter-clockwise.



ORIENTING THE IMAGE

Flip

The  and  buttons let you flip the image left to right or top to bottom before scanning. Changes will be reflected in the prescan image.

- Click on  to view a full screen display of the area inside the cropping frame.

Click on  to flip the image top to bottom.



- The image is upside down compared to the original prescan.

Click on  to flip the image left-to-right.



- Image is backwards compared to the original scan.

ORIENTING THE IMAGE

Cropping

The cropping frame defines how much of the prescan image will be scanned. The dimensions of the cropping frame are displayed in the lower left corner of the prescan window

- Click on  to view a full screen display of the area inside the cropping frame.

To enlarge or reduce the size of the cropping frame...

Click on the cropping frame and drag the pointer in or out.

- Click on the corners and drag to resize the cropping frame proportionally.
- Click on the sides and drag to resize the cropping frame non-proportionally.

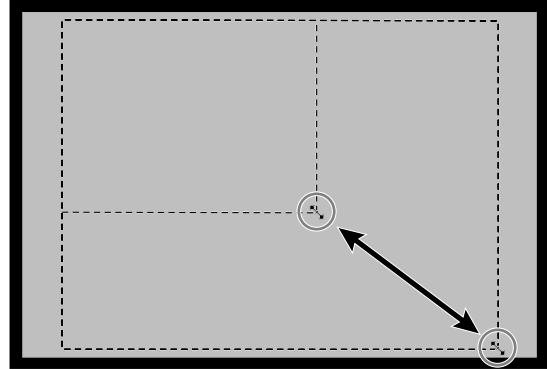

To move the cropping frame...

Click inside the cropping frame, then drag the cropping frame to its new location.

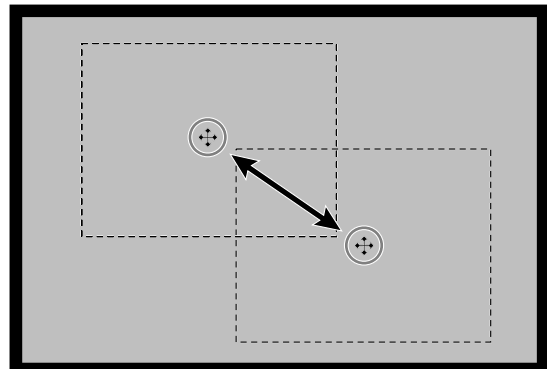

To define a new cropping frame...

Click and drag outside the current cropping frame.

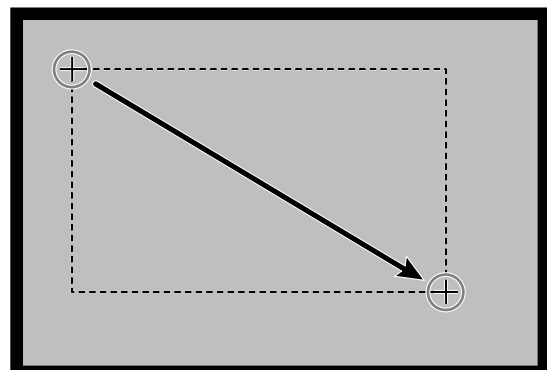

ORIENTING THE IMAGE

Magnifying or Reducing the View

Use the zoom button  to increase or reduce the image magnification.

Zooming In

1. Click on  in the Prescan window.

- The pointer will change to .

2. Click anywhere on the image to zoom in.

- The clicked position will be the center of the magnified view in the Prescan window.
- The + disappears from the magnifier icon when the maximum image magnification has been reached.



Zooming Out

1. Press and hold the Ctrl key (option key on the Macintosh) to reduce the image magnification.

- The pointer will change to .

2. Click anywhere on the image to zoom out.

- The – disappears from the magnifier icon when the minimum image magnification has been reached.



Scroll

Use the grab button to scroll an enlarged image.

-  can only be selected when the image has been magnified beyond the limits of the Prescan window.

1. Click on  in the Prescan window.

- The pointer will change to .

2. Click on and drag the image to the desired location



IMAGE CORRECTION

This scanner gives you three options for correcting the brightness, contrast, and colour balance of the final scan

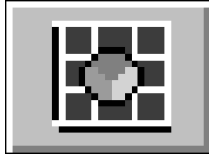

Variations

This is the easiest way to make image corrections and is recommended for beginners. Simply choose the image that looks best from a visual display of contrast and brightness differences. Click on slider bars to correct the colour. A control (uncorrected) and preview (corrected) image appear in the Variations dialog box for comparison.

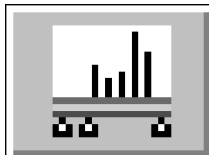

Histogram

The Histogram dialog box gives a graphical representation of the 256 brightness levels for the red, green, and blue colour channels.

Using sliders, the input and output levels can be adjusted to make changes in the brightness, overall contrast, gamma (midtone contrast), and the colour of the image.

A control and preview image appear in the Histogram dialog box for comparison.

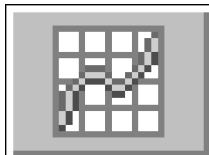

Tone Curves

The Tone Curves dialog box displays correction curves for the red, green, and blue colour channels. Change the brightness, contrast, gamma and colour of the output image by changing the shape of the correction curves.

A control and preview image appear in the Tone Curves dialog box for comparison.



Reset All – Prescan Window

The Reset All button in the Prescan window cancels all corrections applied in the Variations, Histogram, and Tone Curves dialog boxes.

Colour, brightness, and contrast settings are returned to their prescan values.

IMAGE CORRECTION – VARIATIONS

The Variations dialog box lets you quickly correct the brightness and contrast of your image by clicking on simulations that represent varying amounts correction to your image. Correct the colour in your image by clicking on the appropriate colour slider.

- Click on  to view a full screen display of the control and prescan windows.

1. Click on  in the prescan window.

The Variations Dialog Box — Names of Parts

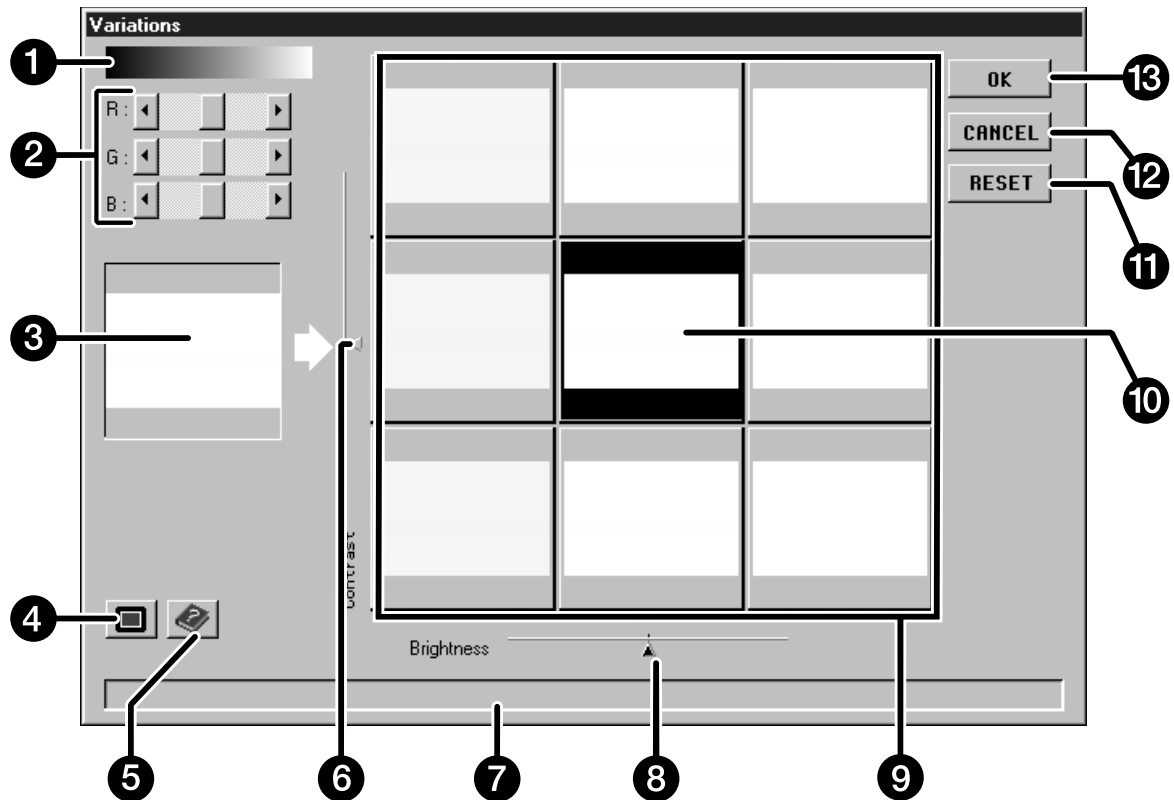

- | | |
|------------------------------|----------------------------|
| ① Grayscale | ⑧ Brightness slider |
| ② RGB sliders | ⑨ Image simulation windows |
| ③ Control image | ⑩ Preview image |
| ④ Full-screen display button | ⑪ Reset button |
| ⑤ Help button | ⑫ Cancel button |
| ⑥ Contrast-level slider | ⑬ OK button |
| ⑦ Status window | |

IMAGE CORRECTION – VARIATIONS

Adjusting the Brightness and Contrast

The image simulation windows map contrast and brightness changes to the preview image. The windows display a one step change in the brightness and contrast, but up to 10 steps (+/-) can be applied. The selected colour, brightness, and contrast changes are automatically applied to the preview image

2. Click on the appropriate window or move the sliders to increase or decrease the contrast and/or brightness.

- The changes are automatically applied to the preview image.
- Additional contrast and brightness simulations will be mapped around the center image.

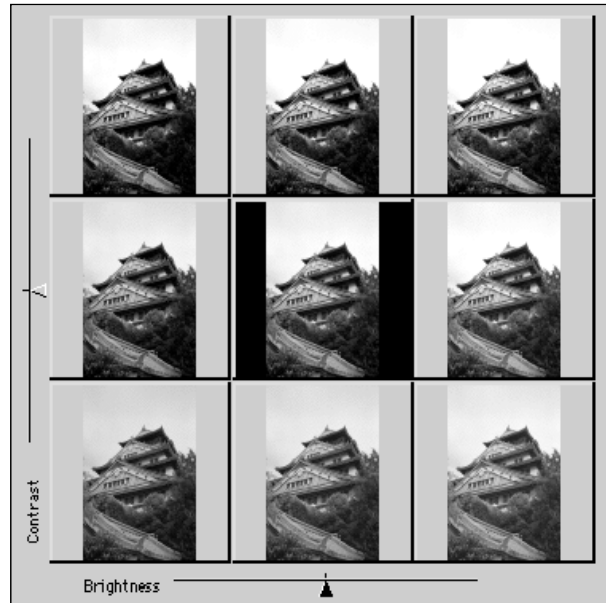
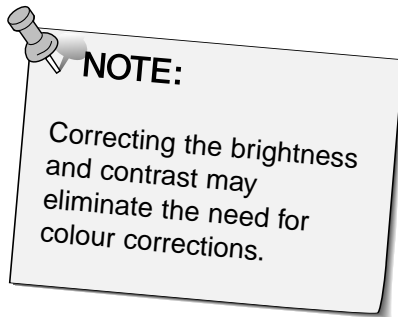

Adjusting the Colour

3. Adjust the colour balance as necessary by clicking on the R, G, and B sliders.

- R can subtract red (left arrow) or subtract cyan (right arrow).
- G can subtract green (left arrow) or subtract magenta (right arrow).
- B can subtract blue (left arrow) or subtract yellow (right arrow).

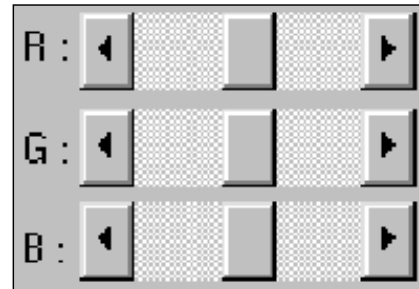

Applying the Corrections

4. Click on to apply the changes to your scan.

- Click on to cancel all corrections and start over.
- Click on to close the variations window without applying any corrections.

IMAGE CORRECTION – HISTOGRAM

The histogram dialog box displays the frequency of occurrence of the 256 levels of brightness (0-255) for each of the colour channels that make up the image area inside the cropping frame. Level 0 is minimum brightness (black). Level 255 is maximum brightness (white). The midtones fall in-between.

- The histograms represent the red, green, and blue brightness levels for the control image. Click on  and hold to view the histograms for the preview image.

Click on  in the prescan window.

The Histogram Dialog Box — Names of Parts

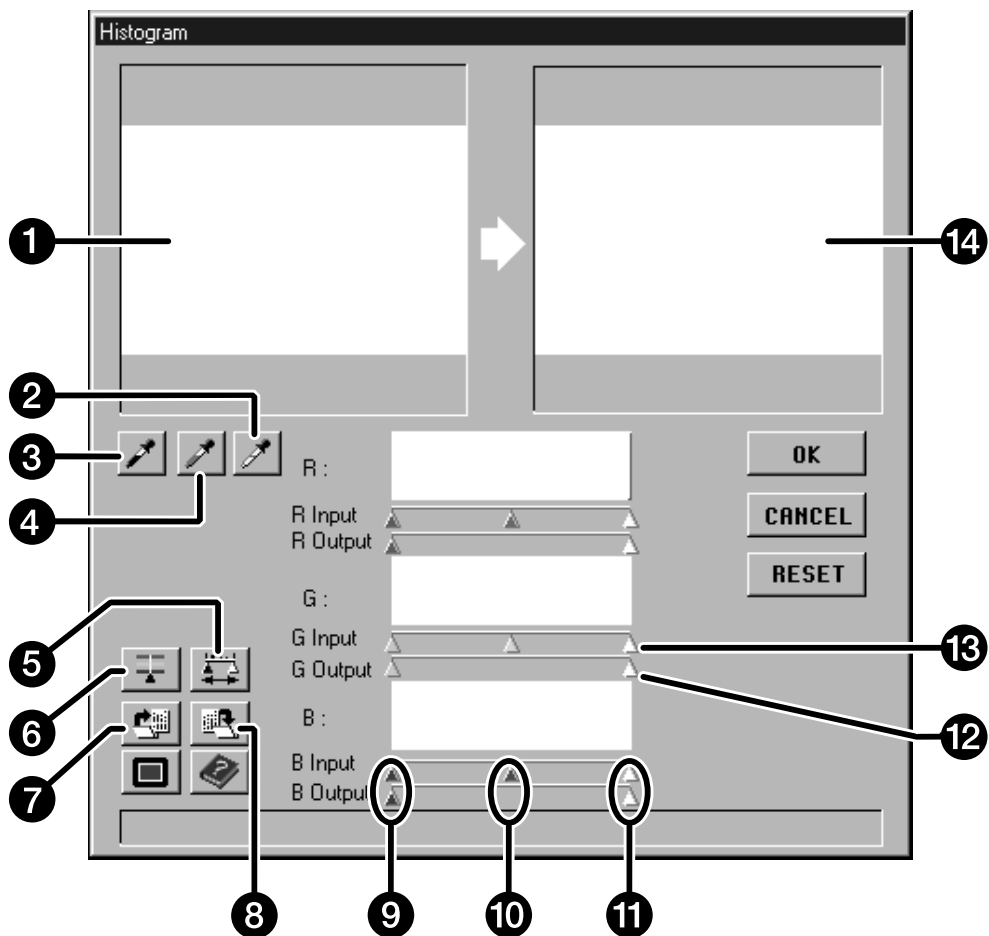

- | | |
|---------------------------|------------------------|
| ① Control image | ⑧ Save settings button |
| ② White point button | ⑨ Shadow sliders |
| ③ Black point button | ⑩ Midtone slider |
| ④ Gray point button | ⑪ Highlight sliders |
| ⑤ Output histogram button | ⑫ Output level sliders |
| ⑥ RGB synchro button | ⑬ Input level sliders |
| ⑦ Load settings button | ⑭ Preview image |

IMAGE CORRECTION – HISTOGRAM

Setting the White, Black, and Gray Points

Properly setting an image's white and black points will usually correct the colour cast and midtone distribution. Properly setting the gray point will correct the colour balance.

- Changes are automatically applied to the preview image.

1. Click on , then click on the tone in the control or prescan image that should be scanned as the brightest neutral white in your image.

- The pointer will change to .
- The RGB brightness values of the selected tone will be changed to 255.



2. Click on , then click on the tone in the control or prescan image that should be scanned as the darkest neutral black in your image.

- The pointer will change to .
- The RGB brightness values of the selected tone will be changed to 0.



3. Click on , then click on the tone in the control or prescan image that should be scanned as a neutral tone.

- The pointer will change to .
- The colour balance of the image is shifted to make the selected tone neutral.
- The selected tone's brightness value does not change.



IMAGE CORRECTION – HISTOGRAM

Brightness and Contrast Changes - RGB Synchro

When RGB synchro is selected, moving the levels sliders remaps the pixel values without changing the colour balance. Correcting the highlight and shadow values with the histogram sliders, may produce better results on images without neutral highlights or shadows.

If the histogram contains large flat line areas...

1. Click on .

- Changes applied to one colour channel will be reflected in the other two.

2. Click on and move the input level highlight and shadow sliders to the edges of the flat line area.

- Changes are automatically applied to the preview image.
- Values to the right of the highlight slider will be scanned as pure white (level 255). Values to the left of the shadow slider will be scanned as pure black (level 0).

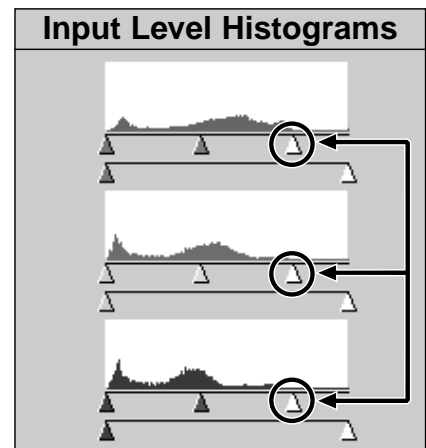

Input level highlight sliders moved to the edge of the flat line area.

3. Click on and slide the output level sliders until the preview image has the desired image contrast.

- Click on  to view a full screen display of the control and preview windows.

4. Click on  and hold to view the output level histograms.

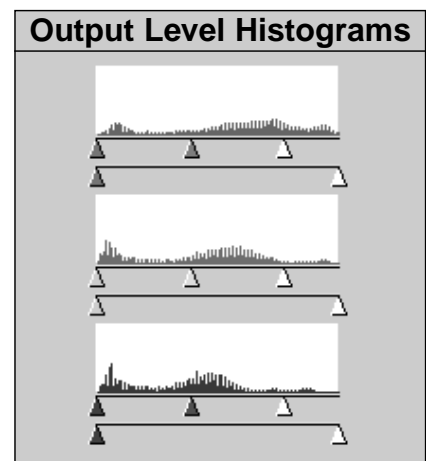

Pixel values have been spread to better utilize the brightness range.

Continued on the following page.

IMAGE CORRECTION – HISTOGRAM

Colour Balance Adjustment - Individual Channels

Changing the slider positions for individual channels affects the colour balance of the output image.

1. Click on  to deselect RGB Synchro.
2. Click on and move the R, G, and B sliders to the desired locations.

- Changes are automatically applied to the preview image.
- Click on  to view a full screen display of the control and preview windows.

3. Click on  and hold to view the output level histograms.

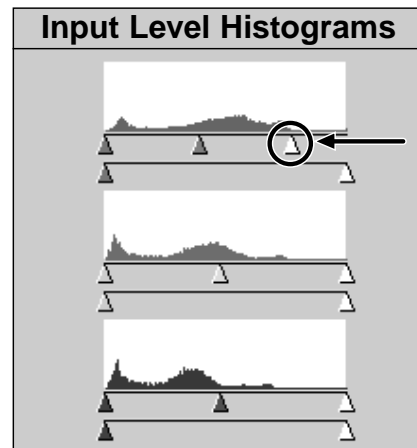

The red input level highlight slider is moved to the edge of the red flat line area.

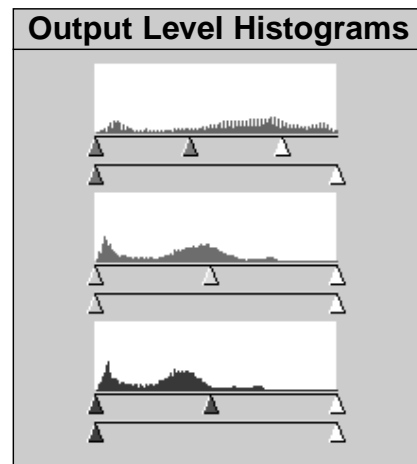

Only the red pixel values have been remapped. Remapping the values of a single colour channel usually affects the colour balance.

Applying or Cancelling Corrections

Click on  to apply or  to cancel the corrections to the image being scanned.

IMAGE CORRECTION – HISTOGRAM

Saving and Loading Histogram Settings

Histogram settings can be saved as a data file that can be loaded and applied to other images.

Save Settings

1. Click on .

- The histogram settings are saved to a data (.dat) file.

2. Enter a file name and the location to save the file, then click on .

The save file dialog box will appear.

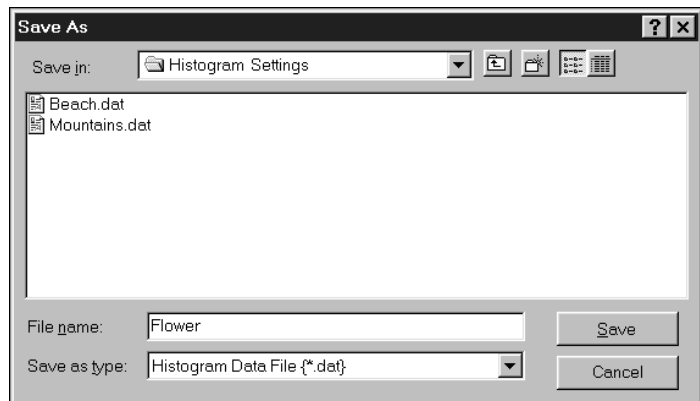

Load Settings

1. Click on .

2. Select the settings file you want to use, then click on

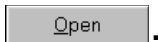

- The settings in the selected file are applied to the current image.

The open file dialog box will appear.

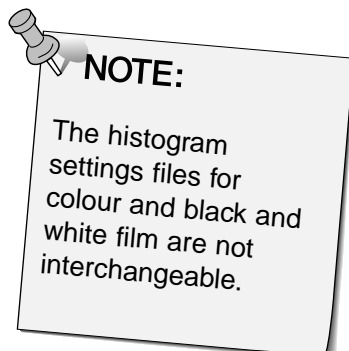
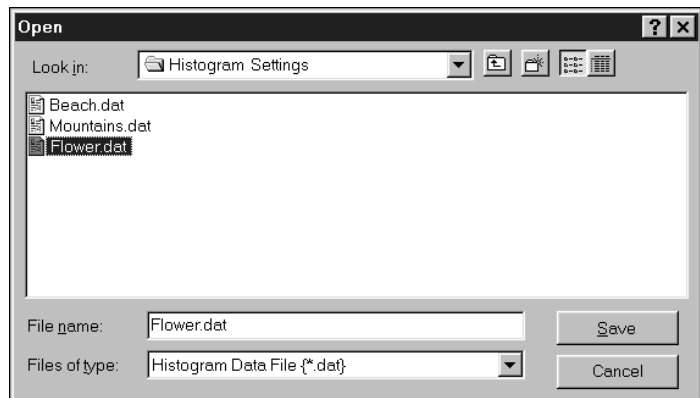

IMAGE CORRECTION – TONE CURVES

The Tone Curves dialog box displays curves for the prescanned image inside the cropping frame. The curve represents the input brightness values (x-axis) in relation to the output values (y-axis). This dialog box allows you to make changes to the tone curves. It is possible to make changes to the individual curves for each channel; red (R), green (G), and blue (B), or to make changes to the overall curve (RGB curve).

- The right side of the curve affects highlights, the left side of the curve affects shadows, and the midtones fall in between. Brightness values are 0 (black) at the bottom of the grid, 255 (white) at the top of the grid, and the middle values fall in between.

Click on  in the prescan window.

Tone Curves Dialog Box — Names of Parts

The curves dialog box will appear.

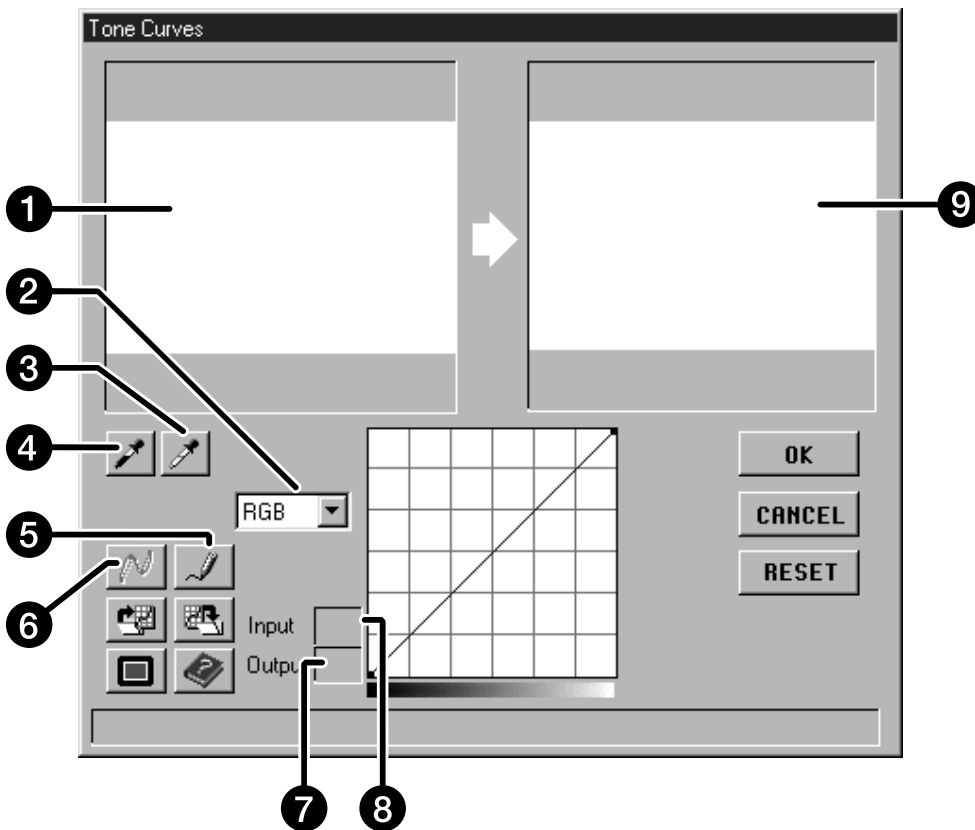

- | | |
|---------------------------|---------------------------|
| ① Control image | ⑥ Calculate button |
| ② Colour channel list box | ⑦ Output brightness value |
| ③ White point button | ⑧ Input brightness value |
| ④ Black point button | ⑨ Preview image |
| ⑤ Free curve button | |

IMAGE CORRECTION – TONE CURVES

Setting the White and Black Points

Properly setting an images white and black points will usually correct the colour cast and midtone distribution.

- Changes are automatically applied to the preview image.

1. Click on , then click on the tone in the control image that should be scanned as the brightest neutral white in your image.

- The pointer changes to .
- The RGB brightness values of the selected tone will be changed to 255.



2. Click on , then click on the tone in the control image that should be scanned as the darkest neutral black in your image.

- The pointer changes to .
- The RGB brightness values of the selected tone will be changed to 0.



Continued on the following page.

IMAGE CORRECTION – TONE CURVES

Correcting the Curves

Changing the shape of a correction curve changes the output level for each corresponding input level. Changing the shape of the red, green, or blue curves affects colour balance of the image. Changes to the RGB curve affect the image contrast and brightness.

1. Select the channel you want to adjust from the colour channel drop down list.



2. Click on and drag the portion of the curve you want to change.

- Changes are automatically applied to the preview image.

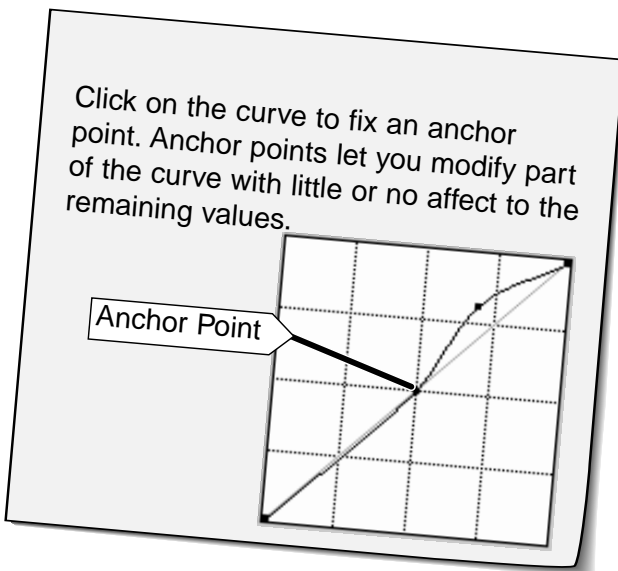

Pull up to increase the output level.

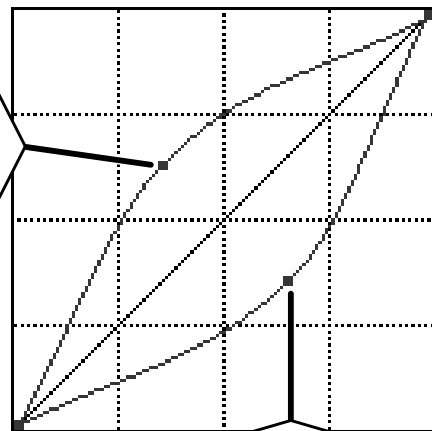

Pull down to decrease the output level.

Click on  to draw a correction curve freehand.

Click on  to smooth out the final correction curve.



NOTE:
Clicking on  draws a smooth curve based on the intersection of the corrected curve through seven input brightness values (31, 63, 95, 127, 159, 191, 223, and 255).

IMAGE CORRECTION – TONE CURVES

Applying or Cancelling Corrections

Click on  to apply or  to cancel the corrections to the image being scanned.

Saving and Loading Tone Curve Settings

Tone Curves settings can be saved as a data file that can be loaded and applied to other images.

Save Settings

1. Click on .

- The Tone Curves settings are saved to a data (.dat) file.

2. Enter a file name and select the location to save the file, then click on .

The save file dialog box will appear.

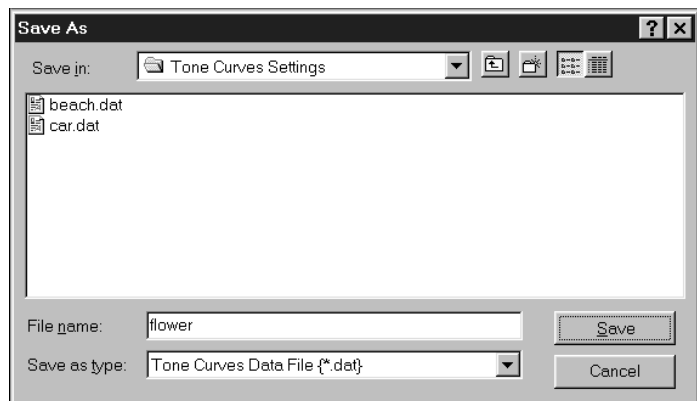

Load Settings

1. Click on .

2. Select the settings file you want to use, then click on

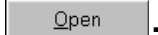
.

- The settings in the selected file are applied to the current image.

The open file dialog box will appear.

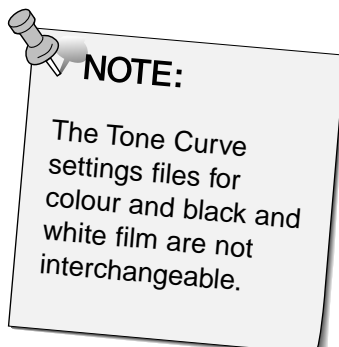
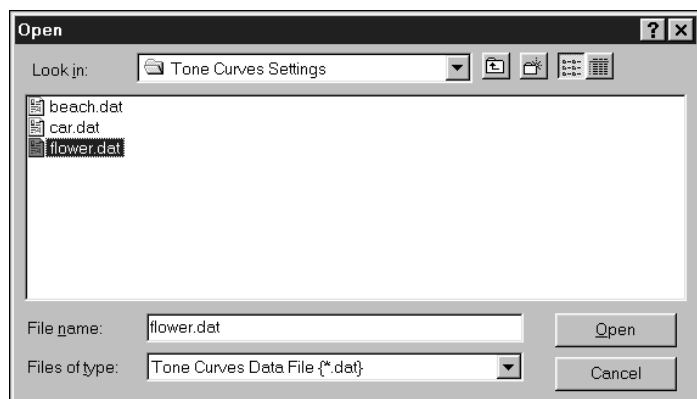

JOB TYPE

Before making the final scan, the scanner needs to know how big the final image will be and the quality of output that will be used (printer, monitor, etc.) so it knows what resolution to scan the film. Using the Job function is a quick and easy way to enter the scan settings.

Job Category	Description
Custom	User created scan settings (p.60).
Colour Laser Printer	Digital colour copiers and colour laser printers Uses output resolution of 400 or 600 dpi. There are two paper-size options; letter and A4.
Photosensitive	Printers that use photosensitive/photographic material Can use output resolutions of 400 dpi, 360 dpi, 267 dpi, and 180 dpi. There are ten paper size options.
Dye-Sub Printer	Dye-sublimation printers Uses an output resolution of 300 dpi. There are 4 paper size options.
Ink Jet Printer	Uses an output resolution of 200 dpi. There are 4 paper size options.
Web Page	For use on home pages Image size is listed in pixels and will vary. Standard Photo CD sizes are also available.
Screen	For monitor display Image size is listed in pixels and will be the VGA standard of 640 x 480 pixels or larger.
Document	For insertion into documents Uses an output resolution of 72 dpi. Image size depends on the paper size selected.
Film Recorder	For high input resolution images that will be output to a film recorder.
Default	This category uses the default settings for the film format. The scan settings appear in the Job Selection window.

JOB TYPE

Loading a Job

Load an existing job and apply it to the current Prescan image.

1. Click on  in the Command window.

The Job Selection dialog box will appear.

2. Select the appropriate category from the drop-down list.

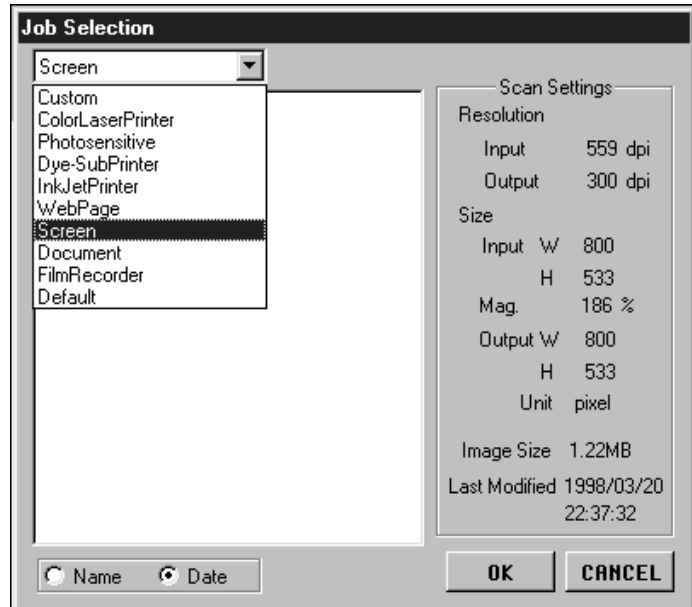

3. Click on the job file name to select it, then click on



- The settings are applied to the active Prescan window.

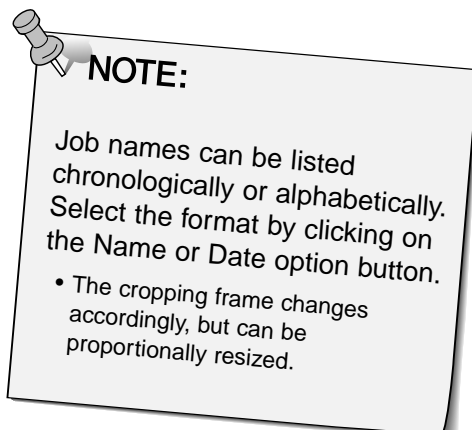
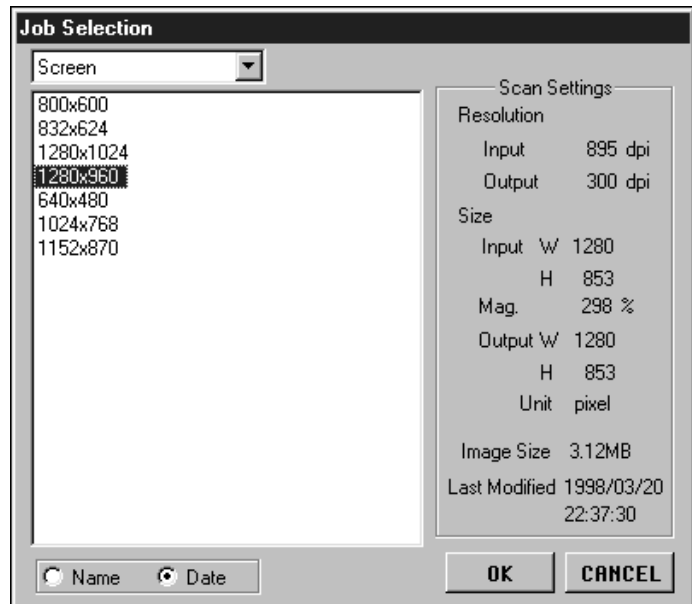

FINAL SCAN

Once all the desired adjustments have been made to the Prescan image and the Job or Scan Settings have been entered, you are ready to scan the film.

Twain Driver / Plug-in Software

With the Prescan image displayed in the Prescan window...

1. Click on  in the Command window.
 - The final scan will begin.
 - When scanning is complete, the final scan will appear in the host application's window.
2. Save the image using the instructions for your host application.
3. Close the Control Window to exit the Dimâge Scan Speed driver software.
 - The driver window will close automatically after each scan if the Close Driver After Scanning option was selected in the Preferences dialog box (p. 22).

Utility Software

With the Prescan image displayed in the Prescan window...

1. Click on  in the Command window.

Your system's standard save dialog box will appear.

2. Enter the desired file name and select the file destination.
3. Select the file type from the drop-down list.

4. Click on .
 - The final scan will begin.
 - When scanning is complete, the scan will be saved in the selected location. The software will return to the Prescan window.

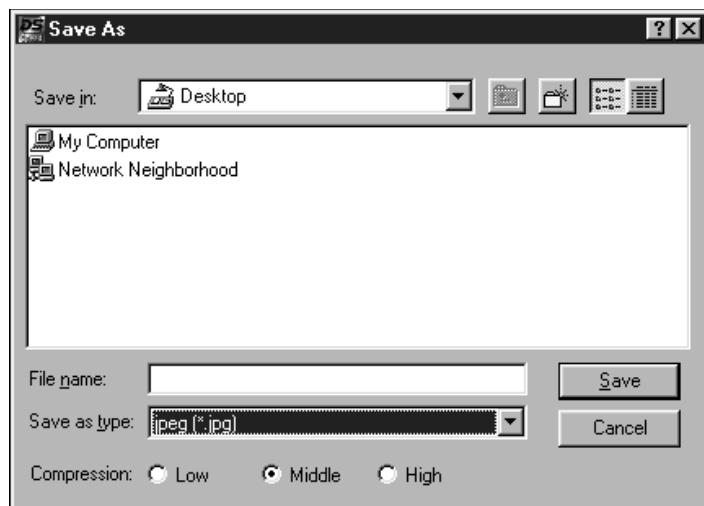

5. Close the Control Window to exit the Dimâge Scan Speed driver software.
 - The driver window will close automatically after each scan if the Close Driver After Scanning option was selected in the Preferences dialog box (p. 22).

SCANNING APS FILM

SCAN FLOW

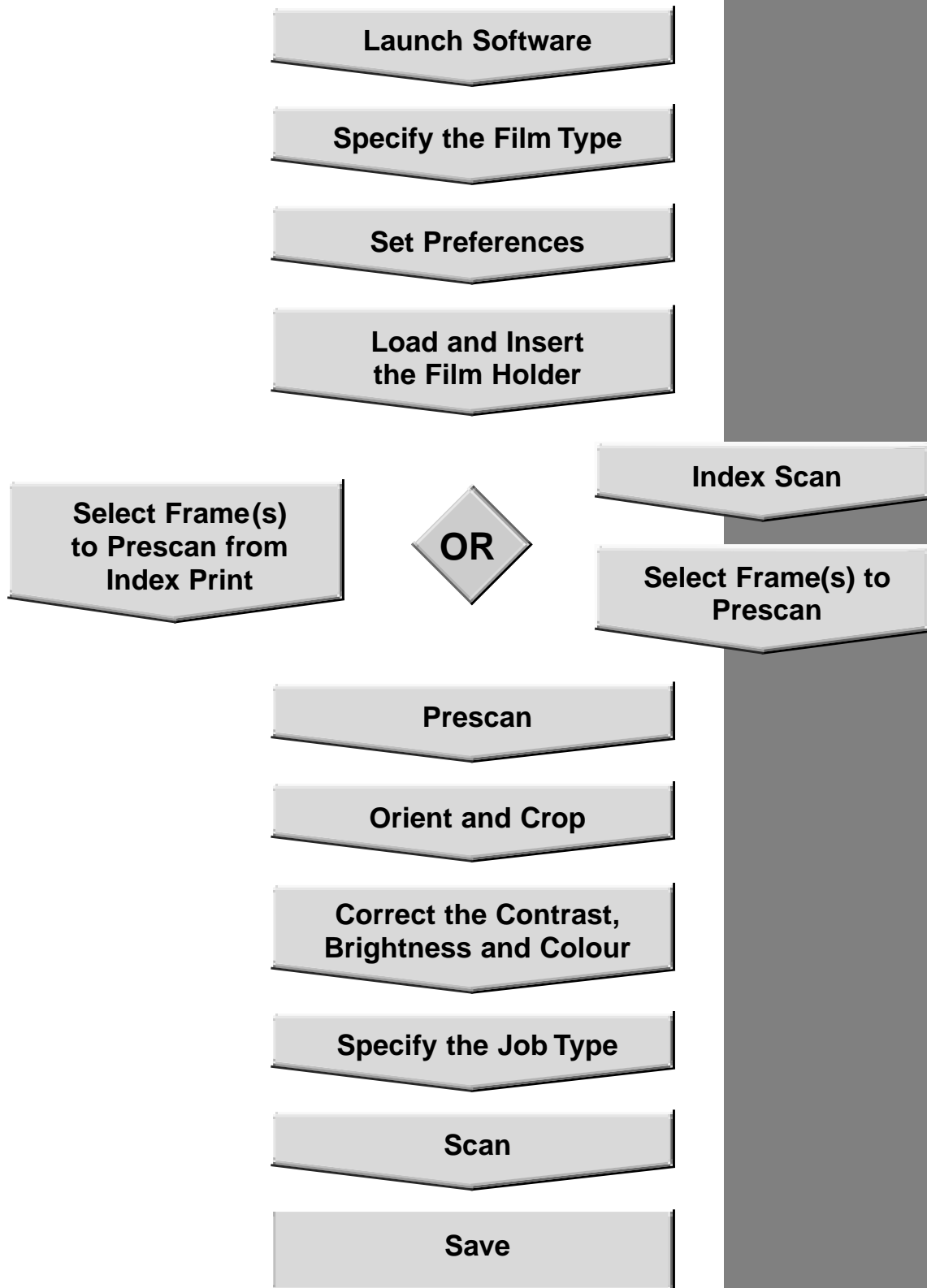

LAUNCH SOFTWARE / SPECIFY FILM TYPE

1. Launch the software (pp. 18-19).

2. Select APS Cassette from the film format drop-down list.

- The Index window appears.

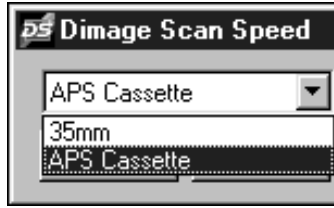

3. Select the film type from the film type drop-down list.

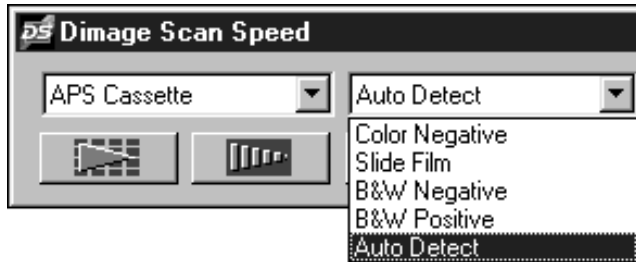

Index Window – Names of Parts

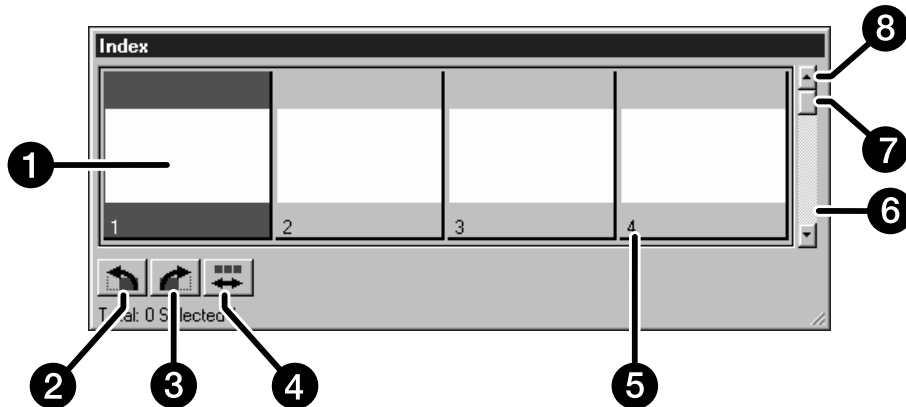

- | | | | |
|---|----------------------------|---|--------------|
| ① | Frame area | ⑤ | Frame number |
| ② | Rotate left button | ⑥ | Scroll bar |
| ③ | Rotate right button | ⑦ | Scroll box |
| ④ | Reverse frame order button | ⑧ | Scroll arrow |

PREFERENCES – APS SETTINGS

1. Click on  in the Control window.

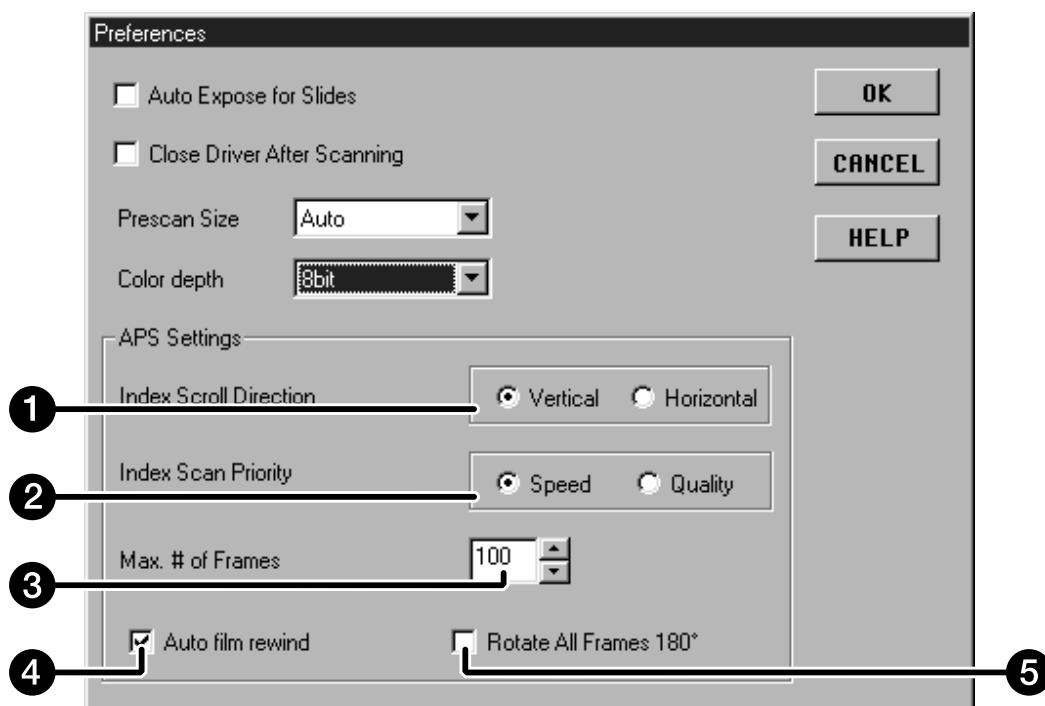

2. Set the preferences as desired.

- De-select the Close Driver After Scanning check box when scanning multiple images at the same time.

1 Index Scroll Direction

Click on the horizontal or vertical scroll direction radio button.

A scroll bar appears when there are more frames in the index window can display.

2 Index Scan Priority

Speed – Creates a thumbnail representation of each frame on the roll.

Quality – Thumbnail and Prescan images are created for each frame on the roll.

- Double-clicking on the index image opens the ready-made prescan image.

3 Maximum Number of Frames

Limits the number of frames that can be scanned at the same time. Type the desired number into the text box or use the arrows to scroll through the values.

- The range is from 1 to 100.

4 Auto Film Rewind

Clicking on the eject button in the Command window automatically rewinds the film into the APS cassette before the APS adapter is ejected.

5 Rotate All Frames 180°

Rotates all frames in the index window 180°.

APS ADAPTER (OPTIONAL)

The AD-10 APS Adapter is an optional accessory. The Dimâge Scan Speed can not scan Advanced Photo System film (IX-240 type) without the AD-10 APS Adapter.

Names of Parts

- ❶ Film-chamber door
- ❷ Film-chamber release
- ❸ Scanner contacts*

* Do not touch

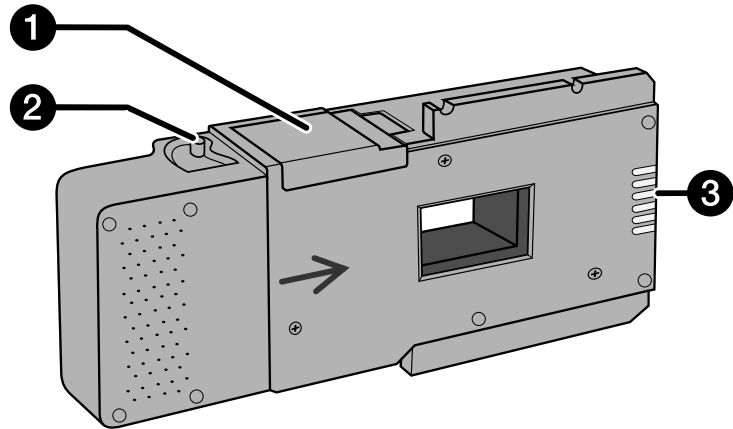

Loading the APS Adapter

1. Slide the film-chamber release as shown.

- The film-chamber door will open.

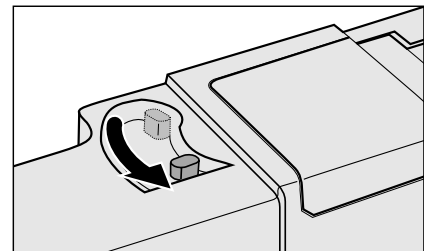

2. Insert the film cassette into the film chamber with the VEI on top.

- Only load cassettes with the ■ mark current.

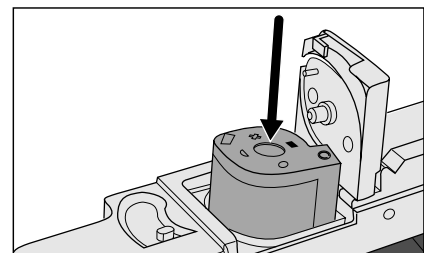

3. Close the film-chamber door.

- The film-chamber door will not close if the ■ mark is not current. Forcing the door shut could damage the cassette.

APS ADAPTER (OPTIONAL)

Inserting the APS Adapter

1. Press to unlock,

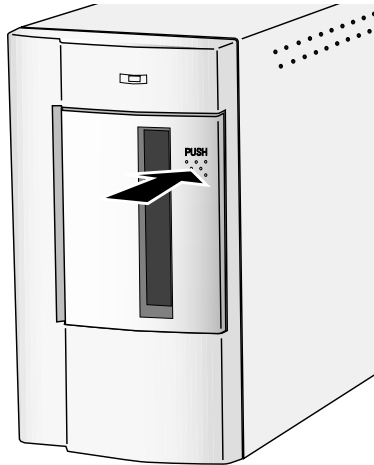

...then open the scanner's film door.

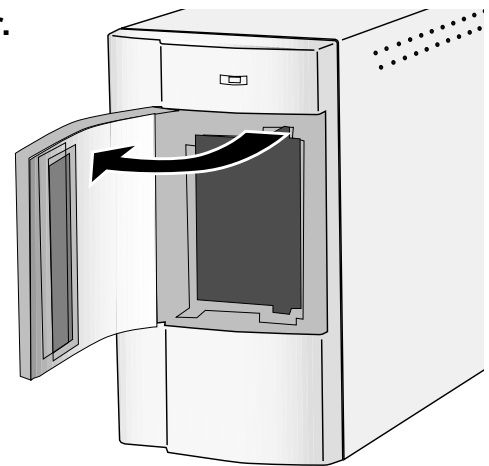

2. Insert the APS Adapter into the scanner.

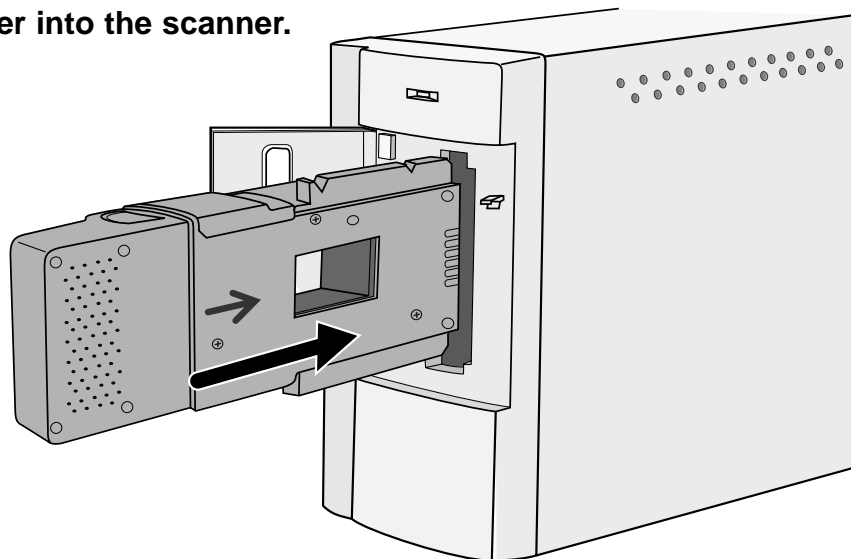

INDEX SCAN

Index scan displays a scan of each image on the cassette in the index window. The time required for an index scan depends on the performance of your machine.

If you don't want to index scan the entire roll, select the frame number of the image you want to scan from the index print provided by your photofinisher. Click on the appropriate image box in the index window to select an image for prescanning or scanning.

- There are two options for making an index scan, Speed or Quality. Select the desired option in the Preference window (p. 49).

Click on  in the Control window.

- All frames on the cassette will be scanned and appear in the Index window.



Click on  to reverse the display order.

NOTE:

- To cancel the index scan, press the escape key (Esc) • Command and period for the Macintosh) until the Cancelling Index Scan message box appears.
- The completed index scans will appear in the index window.
- Frames that have not been index scanned can still be selected for prescanning and scanning.

INDEX SCAN

Changing the Window Size

Change the size of the Index window as desired. The position of the frames will change accordingly.

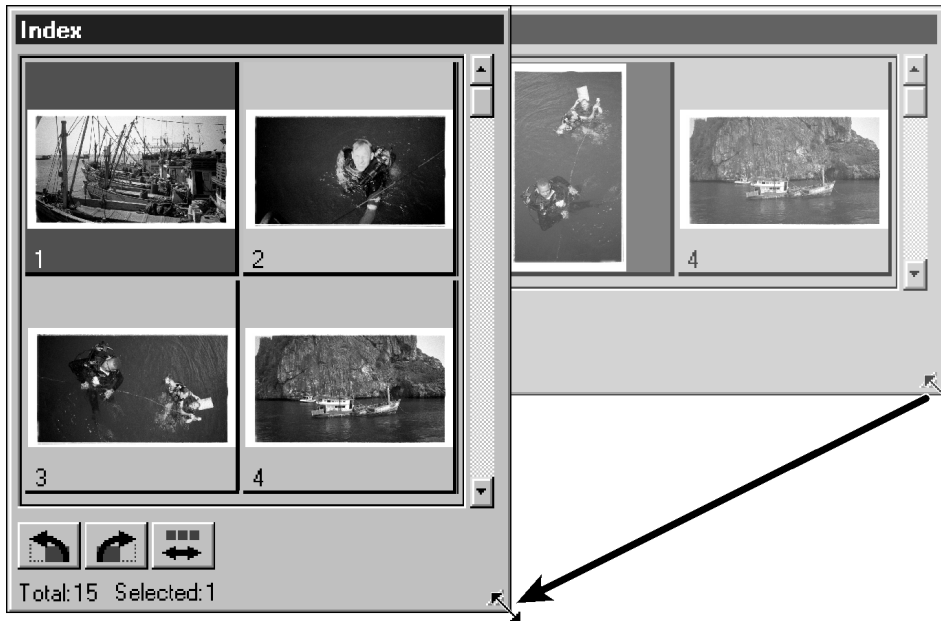



Click on the corner tab and drag to reach the desired size.

- The size and shape of the index frames does not change.

Rotating the Index Frames

Rotate index frames so they appear in the index window with the proper orientation.



Select the desired frames, then click on  or .

- The selected frames will rotate in 90° increments either clockwise or counter-clockwise.
- Rotating the index frame will not affect the Prescan or Scan.

PRESCAN AND IMAGE CORRECTION

1. Click on an image or an image box, then click on . The image will be prescanned, then opened in the Prescan window.

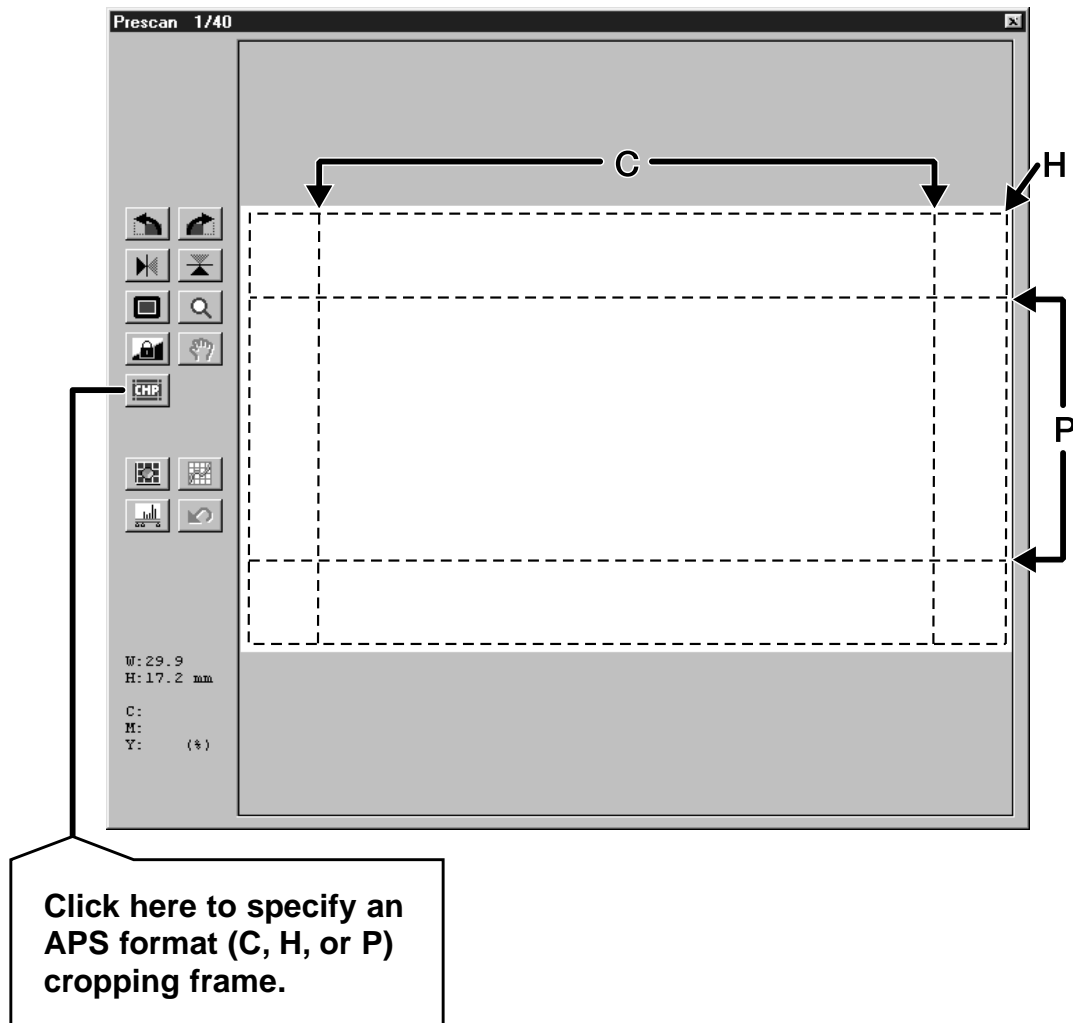

2. Orient and crop the image as desired (pp. 28-31).
3. Apply contrast, brightness, and colour corrections (pp. 32-43).
4. Select the desired job type (pp.44-45).
 - Only one job type can be selected when multiple images are scanned at the same time.
5. Close the Prescan window to return to the Index window.
 - Adjustments made in the Prescan window are held until the image is scanned or the driver software is closed.

SCANNING THE IMAGE

Selecting Frames

1. Click on an image to select it for scanning.

- Selected images are surrounded by a dark gray frame.

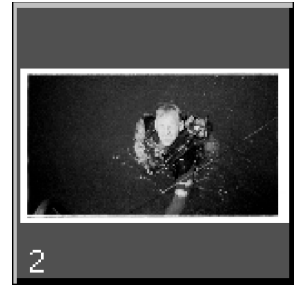

- Press the control key (⌘ key for the Macintosh) while clicking to select additional frames for scanning.
- Press the control key (⌘ key for the Macintosh) while clicking to deselect an image.

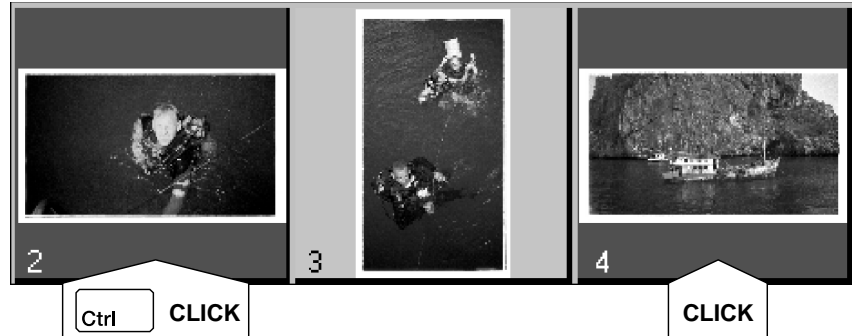

- Press the shift key while clicking to select all the frames between the current frame and the last frame selected.

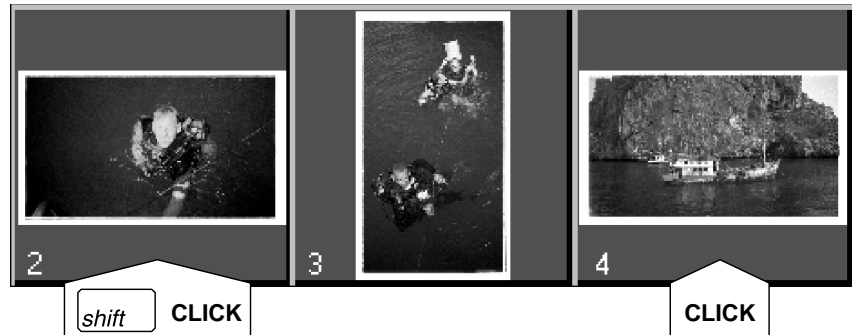

2. Click on to scan the selected image(s).

- The scan is cancelled if more than the number of frames selected is greater than the Max # of Frames set in the Preferences dialog box. See Preferences - APS Settings on page 49.
- The image will be opened in your photo application software when the scanner's driver software is closed.
- Some photo applications can only acquire one image at a time.

3. Refer to page 46 to save the scanned image(s).

- Multiple scans will be saved using the selected file name and numbered chronologically. Example: File_Name01, File_Name02, File_Name03...

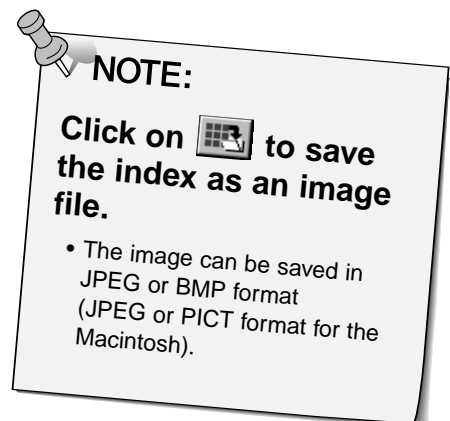

REMOVING THE APS ADAPTER

1. Click on  to rewind the film into the cassette.

- This step is not necessary when the auto rewind option is selected in the Preference window (p.49).

2. Remove the APS adapter from the scanner and close the film door.

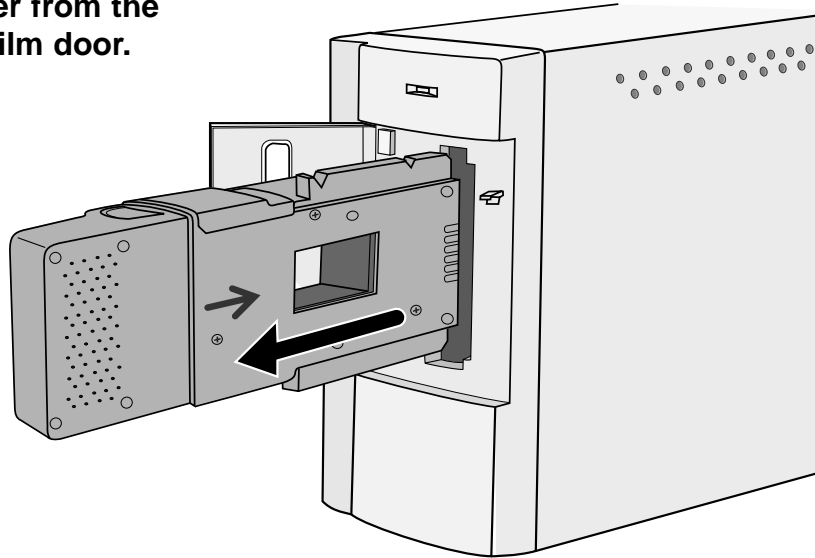

3. Close the Control Window to exit the Dimâge Scan Speed driver software.

- The driver window will close automatically after each scan if the Close Driver After Scanning option was selected in the Preferences dialog box (p.22).

4. Open the APS adapter's film chamber door and remove the cassette.

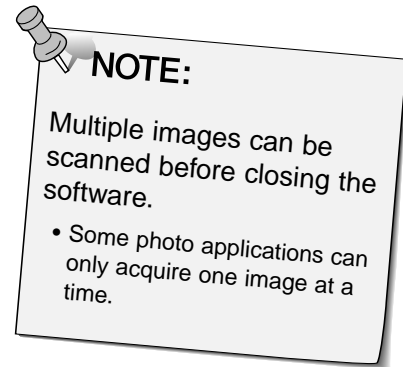

APPENDIX

SCAN SETTINGS

The scan settings determine your final image's resolution, dimensions, and file size, as well as helping determine the image quality. You can select a Job (p. 44) to have the scan settings selected for you or you can directly enter them into the Scan Settings dialog box.

Opening the Scan Settings Dialog Box

Click on  in the command window to display the Scan Settings dialog box.

- ① Input Resolution list box
- ② Output Resolution list box
- ③ Input Size text boxes
- ④ Input Size lock
- ⑤ Magnification text box
- ⑥ Output Size text boxes
- ⑦ Output Size lock
- ⑧ Units list box
- ⑨ Image size display
- ⑩ Reset button

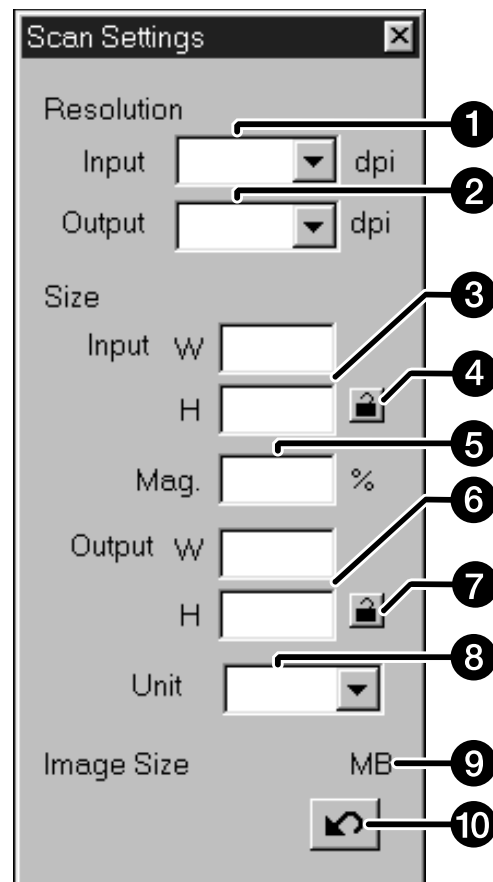

SCAN SETTINGS

Image resolution is the number of pixels per inch (ppi or dpi) that represent your scanned image. The size of an image file is determined by its size (dimensions) and resolution.

The rule to follow when scanning is "bigger is better". To obtain the best results, set the output resolution to the highest value your final output device (printer, monitor, etc.) can handle. The driver software automatically determines the input resolution necessary to obtain the desired output size and resolution.

1. Select Default as the Job category (p.45).

2. Enter the desired output resolution from the output resolution drop-down list.

- Values can also be entered into the output resolution list box directly.
- The output resolution cannot be changed when the unit list box is set to pixels.

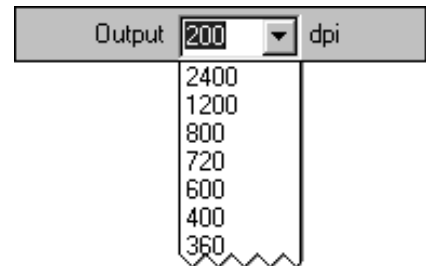

3. The dimensions of the cropping frame are displayed in the input size text boxes.

- Values can be entered directly or by resizing the cropping frame.
- The values will change if a different unit of measure is selected.
- The scanning area size can't be changed if the Input Size is locked.

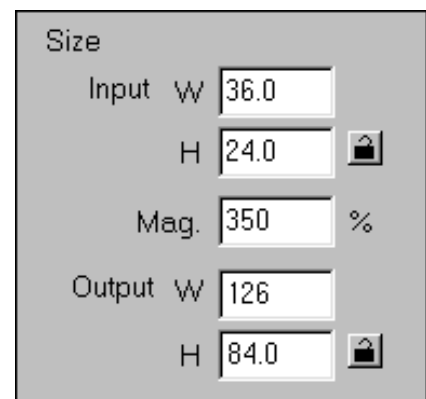

4. Enter the desired output size (maximum 3 digits).

- The output size is limited by the maximum resolution of the scanner.
- The values will change if a different unit of measure is selected.
- The output size cannot be changed when the unit list box is set to pixels.
- The scanning area size can be changed proportionally (within the resolution limits) when the Output Size is locked.

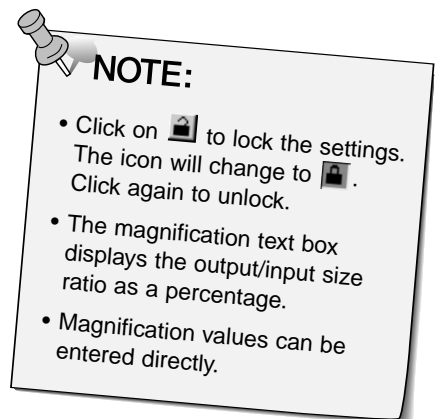

5. The input scan resolution text box is set to the lowest input (scan) resolution necessary to achieve the desired output size and resolution.

- Input scan resolutions can also be selected from the drop down list or entered directly.

CREATING / DELETING JOB FILES

Creating a Job

In addition to the Job settings included with the software, it is possible to create and save your own Job settings.

1. Set the desired settings in the Scan Settings dialog box (p.59).

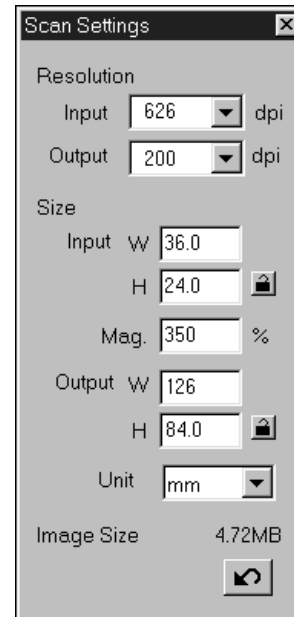

2. Click on  in the command window.

The Job Registry dialog box will appear

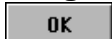
3. Name the job by entering a title and select the desired category, then click on .

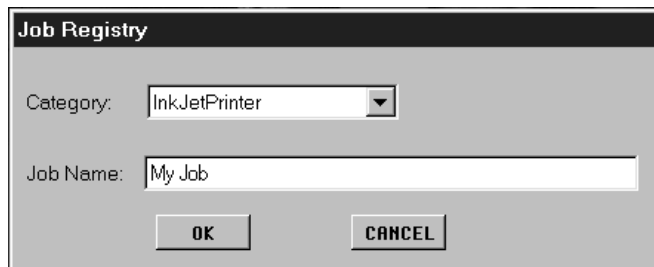

Deleting a Job

It is possible to delete the Job you created when it is no longer needed.

Click on the name of the job in the Job Selection window, then press the delete key on your keyboard.

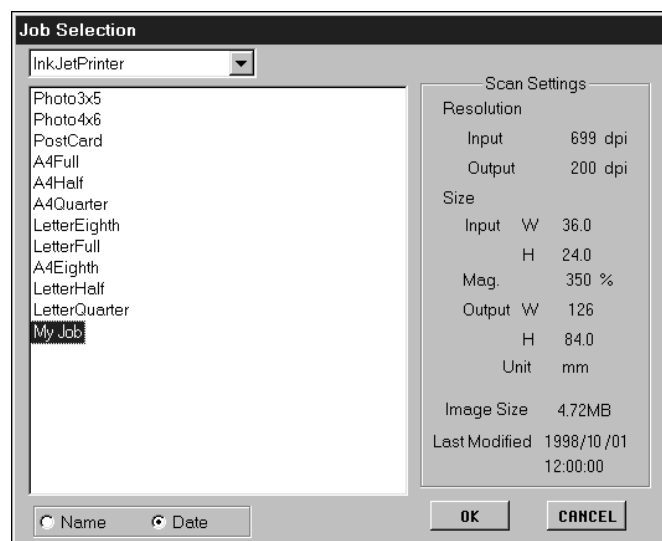

JOB FILE LIST – 35mm

For your reference, the following is a listing of the job categories and names for the 35mm and APS film formats.

Category	Job name	Resolution		Mag.	Unit	Input Size		Input Lock	Output Size		Output Lock
		In	Out			W	H		W	H	
Default	Default	705	300	235	pixel	1008	672	OFF	1008	672	OFF
Colour Laser Printer	Max Size_600dpi	2820	600	470	mm	36.3	24.2	OFF	170.00	113.00	ON
	A4Quarter_600dpi	2447	600	407	mm	36.3	24.2	OFF	148.00	98.70	ON
	A4Eighth_600dpi	1735	600	289	mm	36.3	24.2	OFF	105.00	70.00	ON
	Letter Quarter_600dpi	2291	600	381	inch	1.43	0.95	OFF	5.46	3.64	ON
	Letter Eighth_600dpi	1702	600	283	inch	1.43	0.95	OFF	4.05	2.70	ON
	Max Size_400dpi	2820	400	705	mm	36.3	24.2	OFF	256.00	170.00	ON
	A4Half_400dpi	2313	400	578	mm	36.3	24.2	OFF	210.00	140.00	ON
	A4Quarter_400dpi	1629	400	407	mm	36.3	24.2	OFF	147.00	98.00	ON
	A4Eighth_400dpi	1156	400	289	mm	36.3	24.2	OFF	105.00	69.90	ON
	Letter Half_400dpi	2291	400	572	inch	1.42	0.95	OFF	8.19	5.46	ON
	Letter Quarter_400dpi	1526	400	381	inch	1.43	0.95	OFF	5.45	3.63	ON
	Letter Eighth_400dpi	1133	400	283	inch	1.43	0.95	OFF	4.05	2.70	ON
Photosensitive	Max Size	2820	400	705	mm	36.3	24.2	OFF	256.00	170.00	ON
	A5_400dpi	2313	400	578	mm	36.3	24.2	OFF	210.00	140.00	ON
	8x10_400dpi	2798	400	699	inch	1.43	0.95	OFF	10.00	6.66	ON
	5x7_400dpi	1961	400	490	inch	1.43	0.95	OFF	7.01	4.67	ON
	PostCard4 6_400dpi	1678	400	419	inch	1.43	0.95	OFF	6.00	4.00	ON
	Letter_267dpi	2039	267	763	inch	1.43	0.95	OFF	10.90	7.27	ON
	A4_267dpi	2187	267	819	mm	36.3	24.2	OFF	297.00	198.00	ON
	A5_267dpi	1545	267	578	mm	36.3	24.2	OFF	210.00	140.00	ON
	8x10_267dpi	1870	267	700	inch	1.43	0.95	OFF	10.00	6.67	ON
	5x7_267dpi	1307	267	489	inch	1.43	0.95	OFF	7.00	4.66	ON
	PostCard4 6_267dpi	1120	267	419	inch	1.43	0.95	OFF	6.00	4.00	ON
	(unavailable)	1597	360	443	mm	36.3	24.2	OFF	161.00	107.00	ON
	2L_360dpi	1727	360	479	mm	36.3	24.2	OFF	174.00	116.00	ON
	14x17_180dpi	2123	180	1179	mm	36.3	24.2	OFF	428.00	285.00	ON
	11x14_180dpi	1747	180	970	mm	36.3	24.2	OFF	352.00	235.00	ON
	10x12_180dpi	1494	180	830	mm	36.3	24.2	OFF	301.00	200.00	ON
	(unavailable)	797	180	442	mm	36.3	24.2	OFF	160.00	106.00	ON
	2L_180dpi	857	180	476	mm	36.3	24.2	OFF	173.00	115.00	ON
Dye-Sub Printer	A4Full	2455	300	818	mm	36.3	24.2	OFF	297.00	198.00	ON
	A4Half	1735	300	578	mm	36.3	24.2	OFF	210.00	140.00	ON
	A4Quarter	1223	300	407	mm	36.3	24.2	OFF	148.00	98.70	ON
	A4Eighth	866	300	289	mm	36.3	24.2	OFF	104.00	69.90	ON
	Letter Full	2291	300	763	inch	1.43	0.95	OFF	10.90	7.28	ON
	Letter Half	1714	300	571	inch	1.43	0.95	OFF	8.17	5.44	ON
	Letter Quarter	1144	300	381	inch	1.43	0.95	OFF	5.45	3.63	ON
	Letter Eighth	850	300	283	inch	1.43	0.95	OFF	4.05	2.70	ON
	(unavailable)	1223	300	407	mm	36.3	24.2	OFF	148.00	98.70	ON
	Photo4x6	1240	300	413	mm	36.3	24.2	OFF	150.00	100.00	ON
	Photo3x5 /Photo9x13	1049	300	349	mm	36.3	24.2	OFF	127.00	84.60	ON
Ink-Jet Printer	A4Full	163	200	818	mm	36.3	24.2	OFF	297.00	198.00	ON
	A4Half	1156	200	578	mm	36.3	24.2	OFF	210.00	139.00	ON
	A4Quarter	814	200	407	mm	36.3	24.2	OFF	148.00	98.50	ON
	A4Eighth	577	200	288	mm	36.4	24.3	OFF	105.00	69.80	ON
	Letter Full	1526	200	763	inch	1.42	0.95	OFF	10.90	7.27	ON
	Letter Half	1144	200	572	inch	1.42	0.95	OFF	8.17	5.45	ON
	Letter Quarter	763	200	381	inch	1.43	0.95	OFF	5.45	3.63	ON
	Letter Eighth	566	200	283	inch	1.43	0.95	OFF	4.05	2.70	ON
	(unavailable)	814	200	407	mm	36.3	24.2	OFF	148.00	98.50	ON
	Photo4x6	826	200	413	mm	36.3	24.2	OFF	150.00	100.00	ON
	Photo3x5 /Photo9x13	699	200	349	mm	36.3	24.0	OFF	127.00	84.50	ON

Continued on the following page.

JOB FILE LIST – 35mm

Category	Job Name	Resolution		Mag.	Unit	Input Size		Input Lock	Output Size		Output Lock
		In	Out			W	H		W	H	
Web Page	1023 x 682	716	300	238	pixel	1023	682	OFF	1023	682	ON
	960 x 640	671	300	223	pixel	960	640	OFF	960	640	ON
	870 x 580	608	300	202	pixel	870	580	OFF	870	580	ON
	768 x 512	537	300	179	pixel	768	512	OFF	768	512	ON
	624 x 416	436	300	145	pixel	624	416	OFF	624	416	ON
	600 x 400	419	300	139	pixel	600	400	OFF	600	400	ON
	480 x 320	335	300	111	pixel	480	320	OFF	480	320	ON
	Photo CD 2048 x 3072	2148	300	716	pixel	3072	2048	OFF	3072	2048	ON
	Photo CD 1024 x 1536	1074	300	358	pixel	1536	1024	OFF	1536	1024	ON
	Photo CD512 x 768	537	300	179	pixel	768	512	OFF	768	512	ON
Photo CD256 x 348	243	300	81	pixel	348	232	OFF	348	232	ON	
Screen	1280 x 1024	895	300	298	pixel	1280	853	OFF	1280	853	ON
	1280 x 960	895	300	298	pixel	1280	853	OFF	1280	853	ON
	1152 x 870	805	300	268	pixel	1152	768	OFF	1152	768	ON
	1024 x 768	716	300	238	pixel	1024	682	OFF	1024	682	ON
	832 x 624	582	300	194	pixel	832	554	OFF	832	554	ON
	800 x 600	559	300	186	pixel	800	533	OFF	800	533	ON
640 x 480	47	300	149	pixel	640	426	OFF	640	426	ON	
Document	A4 Half	416	72	577	mm	36.3	24.2	OFF	210.00	139.00	ON
	A4 Quarter	293	72	406	mm	36.4	24.1	OFF	148.00	98.40	ON
	A4 Eighth	207	72	287	mm	36.4	24.3	OFF	105.00	70.00	ON
	Letter Half	411	72	570	inch	1.43	0.95	OFF	8.16	5.44	ON
	Letter Quarter	274	72	379	inch	1.43	0.95	OFF	5.44	3.62	ON
	Letter Eighth	203	72	281	inch	1.44	0.96	OFF	4.04	2.69	ON
Film Recorder	35mm Full-Frame	2382	2400	99	mm	36.30	24.20	OFF	36.00	24.00	ON
	35mm Half-Frame	1586	2400	66	mm	36.30	24.20	OFF	24.00	16.00	ON
	35mm Quarter-Frame	1189	2400	49	mm	36.7	24.40	OFF	18.00	11.90	ON

JOB FILE LIST – APS

Category	Job name	Resolution		Mag.	Unit	Input Size		Input Lock	Output Size		Output Lock
		In	Out			W	H		W	H	
Default	Default	705	300	235	pixel	832	480	OFF	832	480	OFF
Colour Laser Printer	Max Size_600dpi	2820	600	470	mm	29.9	17.2	OFF	140.00	81.20	ON
	A4 Eighth_600dpi	2104	600	350	mm	30.0	17.3	OFF	105.00	60.60	ON
	Letter Eighth_600dpi	2161	600	360	inch	1.18	0.68	OFF	4.25	2.45	ON
	Max Size_400dpi	2820	400	705	mm	29.9	17.2	OFF	211.00	121.00	ON
	A4 Half_400dpi	2809	400	702	mm	29.9	17.2	OFF	210.00	121.00	ON
	A4 Quarter_400dpi	1977	400	494	mm	30.0	17.3	OFF	148.00	85.40	ON
	A4 Eighth_400dpi	1401	400	350	mm	30.0	17.3	OFF	105.00	60.60	ON
	Letter Quarter_400dpi	1851	400	462	inch	1.18	0.68	OFF	5.46	3.15	ON
	Letter Eighth_400dpi	1440	400	360	inch	1.18	0.68	OFF	4.25	2.45	ON
Photosensitive	Max Size	2820	400	705	mm	29.9	17.2	OFF	211.00	121.00	ON
	A5_400dpi	2809	400	702	mm	29.9	17.2	OFF	210.00	121.00	ON
	5x7_400dpi	2374	400	593	inch	1.18	0.68	OFF	7.00	4.04	ON
	Post Card 4 x 6_400dpi	2039	400	509	inch	1.18	0.68	OFF	6.01	3.47	ON
	Letter_267dpi	2472	267	925	inch	1.18	0.68	OFF	10.90	6.30	ON
	A4_267dpi	2654	267	994	mm	29.9	17.2	OFF	297.00	171.00	ON
	A5_267dpi	1870	267	700	mm	30.0	17.2	OFF	210.00	121.00	ON
	8x10_267dpi	2263	267	847	inch	1.18	0.68	OFF	10.00	5.76	ON
	5x7_267dpi	1586	267	594	inch	1.17	0.68	OFF	7.00	4.04	ON
	PostCard4 x 6_267dpi	1359	267	508	inch	1.18	0.68	OFF	6.00	3.46	ON
	(unavailable)	1935	360	537	mm	30.0	17.3	OFF	161.00	92.90	ON
	2L_360dpi	2092	360	581	mm	29.9	17.2	OFF	174.00	100.00	ON
	14x17_180dpi	2578	180	1432	mm	29.9	17.2	OFF	429.00	247.00	ON
	11x14_180dpi	2117	180	1176	mm	29.	17.2	OFF	352.00	203.00	ON
	10x12_180dpi	1809	180	1005	mm	29.9	17.2	OFF	301.00	173.00	ON
(unavailable)	966	180	536	mm	30.0	17.2	OFF	160.00	92.70	ON	
2L_180dpi	1046	180	581	mm	29.9	17.2	OFF	174.00	100.00	ON	
Dye-Sub Printer	Max Size	2820	300	940	mm	29.9	17.2	OFF	281.00	162.00	ON
	A4 Half	2104	300	701	mm	29.9	17.3	OFF	210.00	121.00	ON
	A4 Quarter	1482	300	494	mm	29.9	17.2	OFF	148.00	85.40	ON
	A4 Eighth	1050	300	350	mm	30.0	17.3	OFF	105.00	60.50	ON
	Letter Full	2776	300	925	inch	1.18	0.68	OFF	10.90	6.30	ON
	Letter Half	2161	300	720	inch	1.18	0.68	OFF	8.50	4.90	ON
	Letter Quarter	1385	300	461	inch	1.18	0.68	OFF	5.45	3.14	ON
	Letter Eighth	1080	300	360	inch	1.18	0.68	OFF	4.25	2.45	ON
	(unavailable)	1500	300	500	mm	30.0	17.2	OFF	150.00	86.40	ON
	Photo 9x13	1270	300	423	mm	30.0	17.2	OFF	127.00	73.00	ON
Ink-Jet Printer	A4 Full	1977	200	988	mm	30.0	17.3	OFF	297.00	171.00	ON
	A4 Half	1401	200	700	mm	30.0	17.3	OFF	210.00	121.00	ON
	A4 Quarter	987	200	493	mm	30.0	17.3	OFF	148.00	85.30	ON
	A4 Eighth	700	200	350	mm	30.0	17.3	OFF	105.00	60.40	ON
	Letter Full	1846	200	923	inch	1.18	0.68	OFF	10.90	6.28	ON
	Letter Half	1440	200	720	inch	1.18	0.68	OFF	8.50	4.90	ON
	Letter Quarter	924	200	462	inch	1.17	0.68	OFF	5.45	3.14	ON
	Letter Eighth	720	200	360	inch	1.18	0.68	OFF	4.25	2.45	ON
	Photo 4 x 6	1001	200	500	mm	30.0	17.3	OFF	150.00	86.40	ON
	Photo 3.5 x 5/Photo 9 x 13	846	200	423	mm	30.0	17.2	OFF	127.00	73.00	ON
Web Page	1280 x 739	1085	300	361	pixel	1280	739	OFF	1280	739	ON
	1152 x 665	976	300	665	pixel	1152	665	OFF	1152	665	ON
	1024 x 590	867	300	239	pixel	1024	590	OFF	1024	590	ON
	832 x 480	705	300	235	pixel	832	480	OFF	832	480	ON
	800 x 461	678	300	226	pixel	800	461	OFF	800	461	ON
	640 x 369	542	300	180	pixel	640	369	OFF	640	369	ON
	Photo CD1024 x 1536	1303	300	434	pixel	1536	887	OFF	1536	887	ON
	Photo CD512 x 768	650	300	216	pixel	768	443	OFF	768	443	ON
	Photo CD256 x 348	294	300	98	pixel	348	200	OFF	348	200	ON
Screen	1280 x 1024	1085	300	361	pixel	1280	739	OFF	1280	739	ON
	1280 x 960	1085	300	361	pixel	1280	739	OFF	1280	739	ON
	1152 x 870	976	300	325	pixel	1152	665	OFF	1152	665	ON
	1024 x 768	867	300	289	pixel	1024	590	OFF	1024	590	ON
	832 x 624	705	300	235	pixel	832	480	OFF	832	480	ON
	800 x 600	678	300	226	pixel	800	461	OFF	800	461	ON
Document	640 x 480	542	300	369	pixel	640	369	OFF	640	369	ON
	A4 Half	504	72	700	mm	30.0	17.3	OFF	210.00	121.00	ON
	A4 Quarter	355	72	493	mm	30.0	17.3	OFF	148.00	85.00	ON
	A4 Eighth	251	72	348	mm	30.0	17.3	OFF	105.00	60.30	ON
	Letter Half	518	72	719	inch	1.18	0.68	OFF	8.50	4.90	ON

GLOSSARY

BRIGHTNESS	The lightness or darkness of the image.
CHANNEL	The component of an image. Your scanned image has three channels: red, green, and blue (RGB).
CONTRAST	The gradation of shades in an image. A high contrast image has very dark areas and bright areas without many middle shades. A low contrast image has many tones that are close to the same brightness. Low contrast images are often described as looking 'flat'.
CROP	To trim and delete the unwanted edges of the image.
DPI	Dots (pixels) per inch.
EMULSION SIDE	The side of the film coated with the photographic material.
GAMMA	The contrast of only the middle tones.
HIGHLIGHTS	The lighter areas of the image.
HISTOGRAM	A graph showing the amount of each level of the 256 brightness levels.
INTERPOLATION	A form of adding new pixels in an image when resampling up.
JPEG	The JPEG (Joint Photographic Experts Group) compression standard is capable of producing a high compression ratio while maintaining image quality. JPEG is a widely supported image file format.
MIDTONE	The middle shades of an image, in between light and dark.
NEUTRAL	Having no colour cast, such as black, white, or gray.
PICT	(Macintosh operating system only) The PICT graphic file format uses a lossless compression scheme and is compatible with many Macintosh applications.
PIXEL	Abbreviation for picture element. The dots that make up an electronic image.

GLOSSARY

- RESAMPLE** To change the number of pixels in the image. If pixels are discarded when shrinking an image, it is called resampling down. If new pixels are created in an image, it is called resampling up (p. 59).
- RESOLUTION** The number of pixels in a given area of the image; such as pixels per inch or pixels per centimeter. High resolution is the term for an image with a lot of pixels in a given area. Low resolution means there are not many pixels in a given area.
- RGB** Red, Green, and Blue. These are the colours of the three channels that make up the scanned image. Monitors use red, green, and blue phosphors to create the image you see on the screen.
- SHADOWS** The dark areas of an image.
- TIFF** Tagged Image File Format (TIFF) files contain bit-mapped data. In addition to being a widely supported format, TIFF is able to handle the colour palette needed for professional-quality images and graphics.
- WINDOWS® BMP** (Windows only)The BMP graphic file format is for bit-mapped images. BMP images are supported by the Paint accessory and can easily be opened on most PCs running Windows.

COLORSYNC™ – Macintosh only

ColorSync™ helps your colour devices (monitor, scanner, printer, etc.) match their colours, making it faster and easier to obtain the correct colours in the final image.

The device profile included with the Dimâge Scan Speed driver software is compatible with ColorSync™ ver 2.0 (included with your software). Please remove earlier versions of ColorSync™ before installing the ColorSync™ ver 2.0. system extension

Removing ColorSync ver 1.0

Drag the following items to the trash...

- ColorSync™** (system extension) – Extensions folder
- ColorSync™ System Profile** (control panel) – Control panels folder
- ColorSync™ Profiles folder** - Preferences folder

Installing the DS_Speed ColorSync™ Profile

The included ColorSync™ software can be installed directly from the Dimâge Scan Speed CD-ROM.

1. **Insert the Dimâge Scan Speed CD-ROM into the CD-ROM drive, then click on .**
2. **Double click on the English folder, then double click on the ColorSync™ folder.**

If you just removed ColorSync™ ver 1.0...

Drag  (ColorSync™ System Extension) to the Extensions folder.

Drag  (ColorSync™ System Profile) to the Control Panels folder.

Drag the ColorSync™ Profiles folder to the Preferences folder.

3. **Drag the DS_Speed Profile into the ColorSync™ Profiles folder in the Preferences folder.**
4. **Drag the ColorSync™ filter to the Adobe Photoshop Filters folder located inside the Plug-ins folder.**

TROUBLE SHOOTING

SYMPTOM or MESSAGE	SOLUTION
The computer will not start up after connecting the scanner.	<ul style="list-style-type: none">• Shut down the computer and all the devices in your SCSI chain, then check the SCSI cables, SCSI ID connection, power cord, and SCSI ID.
DS_Speed does not appear in the Acquire drop down list.	<ul style="list-style-type: none">• Make sure the plug-in module has been placed in the correct folder. See page 12.
“Could not establish connection with scanner.”	<ul style="list-style-type: none">• Indicator lamp is off - Turn the Dimâge Scan Speed on, then restart your system.• Check that the SCSI ID is not being used by another SCSI device.
“Setting up now. Remove the film holder.”	<ul style="list-style-type: none">• Remove the film holder and click on OK.
Indicator lamp blinking rapidly (8Hz).	<ul style="list-style-type: none">• Scanner door opened during setup. Close scanner door.
“Set film properly...”	<ul style="list-style-type: none">• Load film into the film holder.
“Set 35mm film holder properly.”	<ul style="list-style-type: none">• Set the correct film type.
“Set APS film holder properly.”	<ul style="list-style-type: none">• Set the correct film type.
“Could not recognize the film type.”	<ul style="list-style-type: none">• Set the film type manually.
“Insufficient Memory”	<ul style="list-style-type: none">• Increase the memory requirements for the host application.• If you have scanned multiple images, close and relaunch the host application.
“Setting up now. Remove the film holder.” appears when the film holder is not loaded.	<ul style="list-style-type: none">• Contact a Minolta Service Facility to change the fluorescent lamp.

SPECIFICATIONS

Type:	Fixed sensor, film transport, single pass	
Usable Film:	35mm - negative/ positive, colour/ B&W APS cassette (with optional adapter) - colour/ B&W, negative/ positive	
Scanning Dimensions:	35mm	- 24.2 x 36.3mm (2688 x 4032 pixels)
	APS	- 17.28 x 29.95mm (1920 x 3328 pixels)
Optical Input Resolution:	2820 dpi	
A/D Conversion:	12 bit	
Image Sensor:	RGB 3-line CCD (2700 pixels)	
Scan Times (approx):	35mm	APS
	6 sec	6 sec
	40 sec	40 sec
	N/A	6 sec/frame
Interface:	SCSI-2	
SCSI Ports:	DB25, Centronics 50	
Light Source:	3 Wavelength Cold Cathode Fluorescent	
Power/Frequency:	North America - 100-120 volts AC, 50/60 Hz Europe - 220-240 volts AC, 50/60 Hz	
Power Consumption:	Max. 30W	
Dimensions (W x H x D):	90.5 x 160.5 x 272mm (3.6 x 6.3 x 10.7 in.)	
Weight (approx):	2.0kg (4.4 lbs.)	

Specifications are based on the latest information available at the time of printing and are subject to change without notice.

USER TECHNICAL SUPPORT

Please contact your dealer for information regarding installation, SCSI-2 interface recommendations, or application compatibility. If your dealer is unable to help you, contact one of the distributors listed on the back cover.

Please have the following information ready when calling Minolta Technical Support.

Make and Model of your computer:

Available application RAM:

Operating System version:

Other connected SCSI devices:

DS Speed driver version number:

Symptoms:

Messages that appear on the screen when the problem occurs:

Frequency of occurrence:

Determining the version number of your driver software:

Place the pointer on the status window in the command window to display the version number and SCSI ID.

Minolta Co., Ltd.	3-13, 2-Chome, Azuchi-Machi, Chuo-Ku, Osaka 541-8556, Japan
Minolta Corporation	
Head Office	101 Williams Drive, Ramsey, New Jersey 07446, U.S.A.
Los Angeles Branch	11150 Hope Street Cypress, CA 90630, U.S.A.
Minolta Canada Inc.	
Head Office	369 Britannia Road East, Mississauga, Ontario L4Z 2H5, Canada
Minolta GmbH	Kurt-Fischer-Strasse 50, D-22923 Ahrensburg, Germany
Minolta France S.A.	365 Route de Saint-Germain, F-78420 Carrieres-Sur-Seine, France
Minolta (UK) Limited	Rooksley Park, Precedent Drive, Rooksley, Milton Keynes, MK13 8HF, England
Minolta Austria Ges. m.b.H.	Amalienstrasse 59-61, A-1131 Wien, Austria
Minolta Camera Benelux B.V.	Zonnebaan 39, P.O. Box 6000, NL-3600 HA Maarssen, The Netherlands
Minolta (Schweiz) AG	Riedstrasse 6, CH-8953 Dietikon, Switzerland
Minolta Svenska AB	P.O.Box 9058, Albygatan 114, S-17109 Solna, Sweden
Minolta Hong Kong Limited	Room 208, 2/F, Eastern Center, 1065 King's Road, Quarry Bay, Hong Kong, China
Minolta Singapore (Pte) Ltd.	10, Teban Gardens Crescent, Singapore 608923

© 1998 Minolta Co., Ltd. under the Berne Convention and
Universal Copyright Convention