

MINOLTA

The essentials of imaging

www.minoltaeurope.com



DIMAGE **E 223**

E INSTRUCTION MANUAL

Before you begin

Thank you for purchasing this Minolta digital camera. Please take the time to read through this instruction manual so you can enjoy all the features of your new camera.

Check the packing list before using this product. If any items are missing, immediately contact your camera dealer.

Minolta DiMAGE E223 digital camera
AA alkaline batteries (set of two)
Hand strap HS-DG223
Video cable VIC-100
USB cable USB-700
DiMAGE Viewer CD-ROM
DiMAGE Instruction Manuals CD-ROM
Quick Reference Guide (printed)
Minolta International Warranty Certificate

Because the performance of alkaline batteries with digital cameras is low, the use of Ni-MH batteries or a CR-V3 lithium battery is recommended.

Apple, Macintosh, and Mac OS are registered trademarks of Apple Computer Inc. Microsoft and Windows are registered trademarks of the Microsoft Corporation. The official name of Windows is Microsoft Windows Operating System. Pentium is a registered trademark of the Intel Corporation. QuickTime is a trademark used under license. All other trademarks are the property of their respective owners.

For proper and safe use

Read and understand all warnings and cautions before using this product.

WARNING

Using batteries improperly can cause them to leak harmful solutions, overheat, or explode which may damage property or cause personal injury. Do not ignore the following warnings.

- Only use the batteries specified in this instruction manual.
- Do not install the batteries with the polarity (+/-) reversed.
- Do not use batteries which show wear or damage.
- Do not expose batteries to fire, high temperatures, water, or moisture.
- Do not attempt to short or disassemble batteries.
- Do not store batteries near or in metallic products.
- Do not mix batteries of different types, brands, ages, or charge levels.
- Do not charge alkaline or lithium batteries.
- When recharging rechargeable batteries, only use the recommended charger.
- Do not use leaking batteries. If fluid from the batteries enters your eye, immediately rinse the eye with plenty of fresh water and contact a doctor. If fluid from the batteries makes contact with your skin or clothing, wash the area thoroughly with water.
- Tape over battery contacts to avoid short-circuiting during disposal; always follow local regulations for battery disposal.

- Use only the specified AC adapter within the voltage range indicated on the adapter unit. An inappropriate adapter or current may cause damage or injury through fire or electric shock.
- Do not disassemble this product. Electric shock may cause injury if a high voltage circuit inside the product is touched.
- Immediately remove the batteries or unplug the AC adapter and discontinue use if the camera is dropped or subjected to an impact in which the interior, especially the flash unit, is exposed. The flash has a high voltage circuit which may cause an electric shock resulting in injury. The continued use of a damaged product or part may cause injuries or fire

- Keep batteries or small parts that could be swallowed away from infants. Contact a doctor immediately if an object is swallowed.
- Store this product out of reach of children. Be careful when around children not to harm them with the product or parts.
- Do not fire the flash directly into the eyes. It may damage eyesight.
- Do not fire the flash at vehicle operators. It may cause a distraction or temporary blindness which may lead to an accident.
- Do not use the monitor while operating a vehicle or walking. It may result in injury or an accident.
- Do not look directly at the sun or strong light sources through the viewfinder. It may damage your eyesight or cause blindness.
- Do not use this product in a humid environment, or operate this product with wet hands. If liquid enters the product, immediately remove the batteries or unplug the AC adapter and discontinue use. The continued use of a product exposed to liquids may cause damage or injury through fire or electric shock.
- Do not use the product near inflammable gases or liquids such as gasoline, benzine, or paint thinner. Do not use inflammable products such as alcohol, benzine, or paint thinner to clean the product. The use of inflammable cleaners and solvents may cause an explosion or fire.
- When unplugging the AC adapter, do not pull on the power cord. Hold the adapter unit when removing it from an outlet.
- Do not damage, twist, modify, heat, or place heavy objects on the AC adapter cord. A damaged cord may cause damage or injury through fire or electric shock.
- If the product emits a strange odor, heat, or smoke, discontinue use. Immediately remove the batteries taking care not to burn yourself as the batteries become hot with use. The continued use of a damaged product or part may cause injuries or fire.
- Take the product to a Minolta Service Facility when repairs are required.



CAUTION

- Do not use or store the product in a hot or humid environment such as the glove compartment or trunk of a car. It may damage the product and batteries which may result in burns or injuries caused by heat, fire, explosion, or leaking battery fluid.
- If batteries are leaking, discontinue use of the product.
- The lens retracts when the camera is turned off. Touching the lens barrel while it is retracting may cause injury.
- The camera temperature rises with extended periods of use. Care should be taken to avoid burns.
- Burns may result if the memory card or batteries are removed immediately after extended periods of use. Turn the camera off and wait for it to cool.
- Do not fire the flash while it is in contact with people or objects. The flash unit discharges a large amount of energy which may cause burns.
- Do not apply pressure to the LCD monitor. A damaged monitor may cause injury, and the liquid from the monitor may cause inflammation. If liquid from the monitor makes contact with skin, wash the area with fresh water. If liquid from the monitor comes in contact with the eyes, immediately rinse the eyes with plenty of water and contact a doctor.
- When using the AC adapter, insert the plug securely into the electrical outlet.
- Do not use if the AC adapter cord is damaged.
- Do not cover the AC adapter. A fire may result.
- Do not obstruct access to the AC adapter; this can hinder the unplugging of the unit in emergencies.
- Unplug the AC adapter when cleaning or when the product is not in use.

About this manual

The basic operation of this camera is covered between pages 10 and 25. This section of the manual covers the camera parts, preparation of the camera for use, and the basic camera operation for recording, viewing, and deleting images.

The other sections can be read as needed. Many of the features of this camera are controlled with menus. The menu navigation sections concisely describe how to change menu settings. Descriptions of the settings immediately follow the navigation sections.

Names of parts	8
Camera body	8
Mode dial	9
Getting up and running	10
Attaching the hand strap	10
Installing batteries.....	11
Battery condition indicator	12
Auto power off.....	12
Connecting the AC adapter (sold separately)	13
Setting the language.....	14
Setting the date and time	14
Image storage.....	16
Basic recording and playback.....	18
Auto-recording mode display	18
Frame counter	18
Viewfinder	19
Handling the camera	19
Using the zoom lens.....	20
Basic recording operation.....	21
Indicator lamp	22
Focus lock.....	22
Special focusing situations	23
Playback mode display	24
Viewing images.....	24
Display button - playback mode.....	25
Deleting images	25

Auto-recording mode	26
Flash modes	26
Flash range.....	27
Display button - recording mode.....	27
Exposure compensation	28
What is an Ev? What is a stop?	29
White balance	30
Automatic white balance.....	30
Preset white balance	30
Movie-recording	31
Program-recording mode	32
Self-timer	32
Macro.....	33
Night portrait.....	33
Portrait	33
Landscape	33
Playback mode	34
Index playback.....	34
Enlarged playback	35
Playing back movies.....	35
Image copy	36
Viewing images on a television	37
Setup mode	38
Navigating the setup menu.....	38
Deleting all images	40
Format	40
Image quality	41
Buzzer.....	42
About DPOF	42
Creating a DPOF Print Order	43
Memory type.....	45
Video output	45
Data-transfer mode	46
System requirements.....	46
Connecting the camera to a computer	47
Connecting to Windows 98 and 98 Second Edition	49
QuickTime system requirements	51
Memory card folder organization.....	52
Uninstalling the driver software - Windows.....	53
Disconnecting the camera from the computer.....	54
Appendix	56
Troubleshooting	56
Care and storage.....	58
About Ni-MH batteries	60
About the DiMAGE Viewer	60
Technical specifications	61

NAMES OF PARTS

Camera body

* This camera is a sophisticated optical instrument. Care should be taken to keep these surfaces clean. Please read the care and storage instructions in the back of this manual (p. 58).

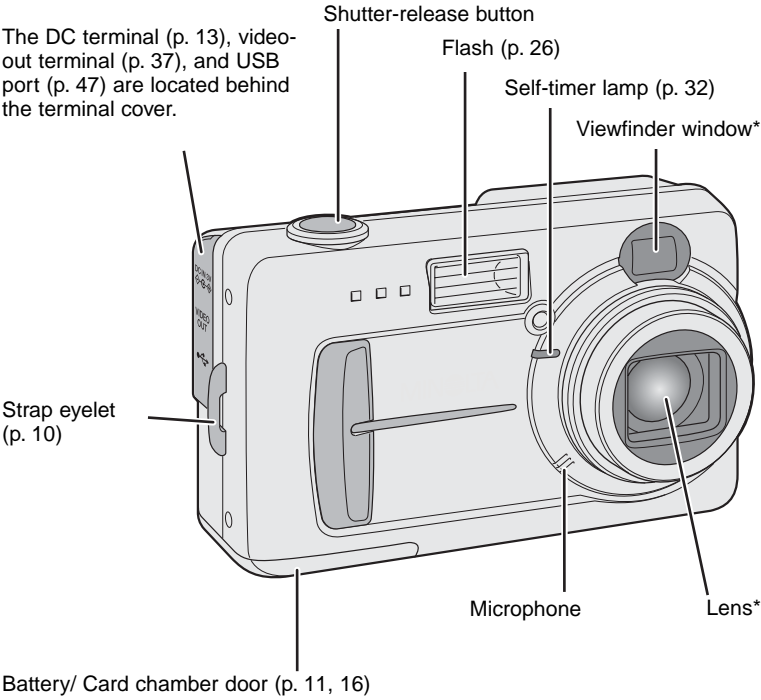



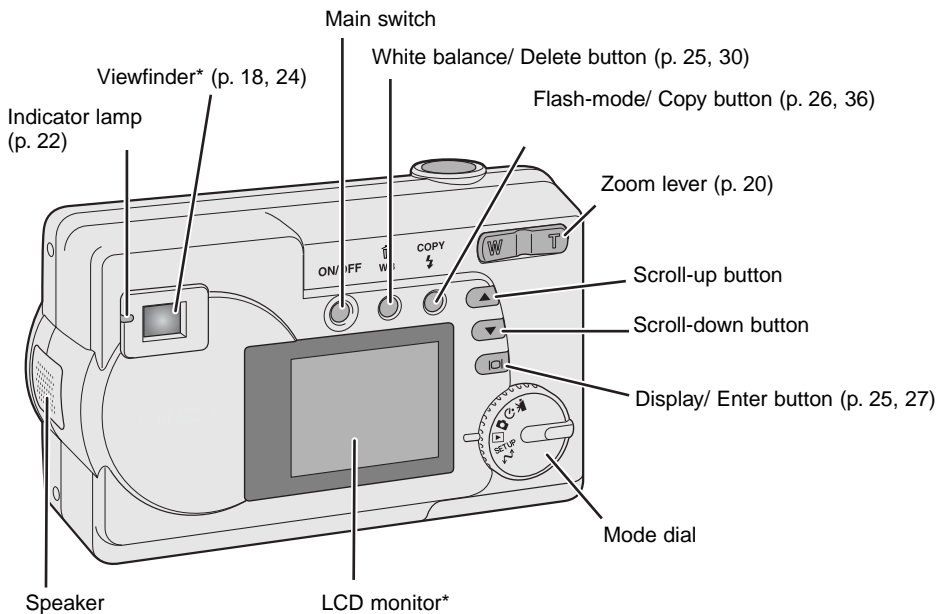



The tripod socket is located on the bottom of the body.

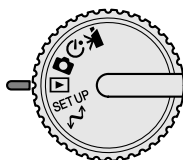

Mode dial

This dial gives direct and easy access to the camera's major modes.



-  Movie-recording mode (p. 31)
-  Program-recording mode (p. 32)
-  Auto-recording mode (p. 18, 26)
-  Playback mode (p. 24, 34)
- SETUP** Setup mode (p. 38)
-  Data-transfer mode (p. 46)

GETTING UP AND RUNNING

Attaching the hand strap

Always keep the strap around your wrist in the event that the camera is accidentally dropped.

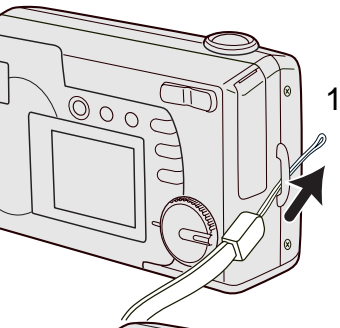

Pass the small loop of the hand strap through the strap eyelet on the camera body (1).

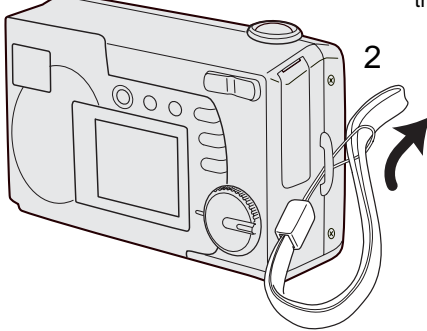

Pass the other end of the strap through the small loop and tighten (2).

Installing batteries

This digital camera uses two AA-size Ni-MH batteries or one CR-V3 lithium battery. When using Ni-MH batteries, fully recharge them with a battery charger suitable for complex electronic equipment. Although alkaline batteries can be used, their performance is very low and is not recommended for normal use. Do not use other types of AA batteries.

When replacing the batteries, the camera should be turned off.

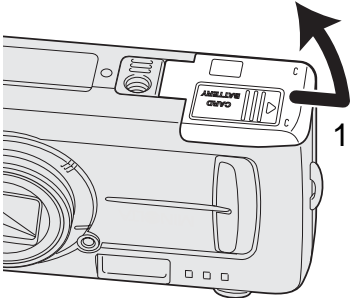

2 Open the battery-chamber door on the bottom of the camera by sliding the door toward the side of the camera (1) to release the safety catch; the door can then be opened (2).

Insert the batteries as shown. Never force the battery.

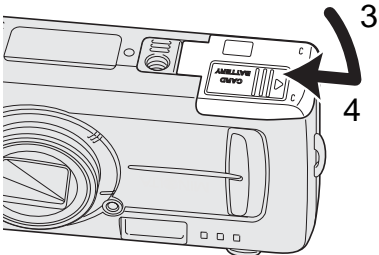
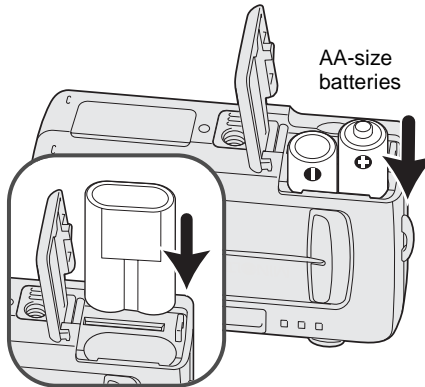

3 Close the battery-chamber door (3) and slide it toward the body (4) to engage the safety catch.

When replacing batteries, the date information will reset if there are no batteries in the camera for a few minutes. See page 14 if the date reset.

Battery condition indicator

This camera is equipped with an automatic battery-condition indicator. When the camera is on, the battery-condition indicator appears on the LCD monitor. If it does not appear, the battery may be exhausted or installed incorrectly.



Full-battery indicator - the battery is fully charged.



Low-battery indicator - battery power is low. The battery should be replaced soon.



Low-battery warning - battery power is very low. The icon is red. The battery should be replaced as soon as possible.

Replace-battery message - power is insufficient for camera operation. Indicator lamp by the viewfinder turns red and blinks. Change the batteries. The shutter will not release.

Auto power off

To conserve battery power, the camera will shut down if an operation is not made within three minutes. To restore power, press the main switch.

Connecting the AC adapter (sold separately)

The AC Adapter AC-6 allows the camera to be powered from an electrical household outlet. The AC Adapter is recommended when the camera is interfaced with a computer or during periods of heavy use.

Always turn off the camera before changing between power supplies.

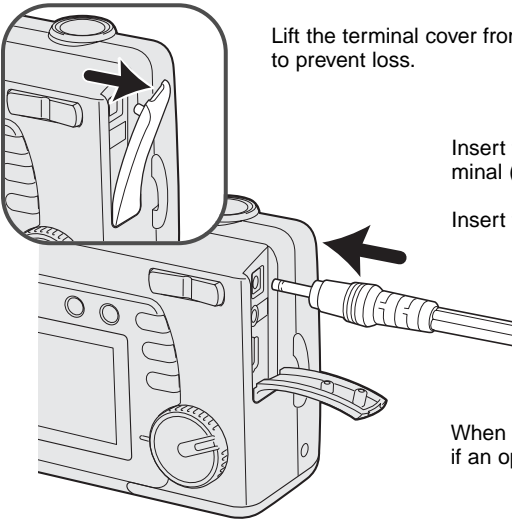

Lift the terminal cover from the top (1). The cover is attached to the body to prevent loss.

Insert the mini plug of the AC adapter into the DC terminal (2).

Insert the AC adapter plug into an electrical outlet.

When the AC adapter is used, camera will shut down if an operation is not made within 30 minutes.

Setting the language

Depending on the region, the menu language may have to be set. Four languages are available: English, French, Spanish, and German.

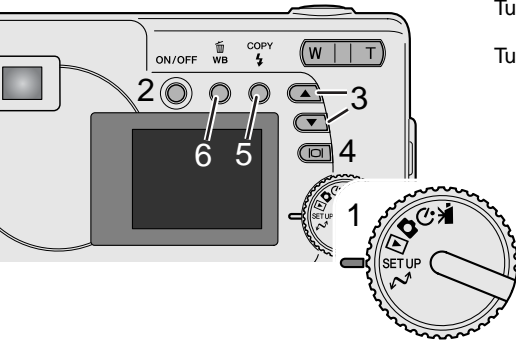

Turn the mode dial to the setup position (1).

Turn the camera on (2).



Use the scroll buttons (3) to select the language option. Press the display/enter button (4) to open language screen.

Use the scroll buttons (3) to highlight the appropriate language. Press the display/enter button (4) to select the language.

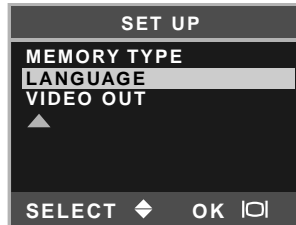

Setting the date and time

The camera's clock and calendar must be set. When images are recorded, the image data is saved with the date and time of recording. The date and time display blinks if the clock and calendar are not set.

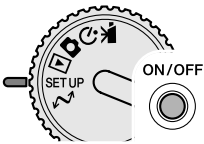

Turn the mode dial to the setup position (1).

Turn the camera on (2).



Use the scroll buttons (3) to select the date/time option. Press the display/enter button (4) to open the date/time screen.

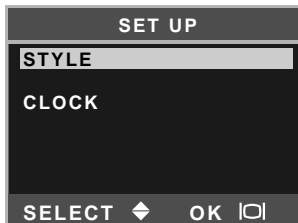
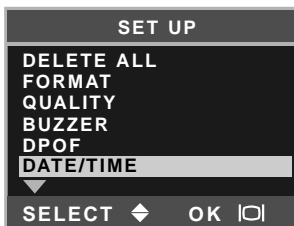

Use the scroll buttons (3) to select the style option. Press the display/enter button (4) to continue.

Use the scroll buttons (3) to select the date format. Press the display/enter button (4) to select the format.

The main setup menu is displayed. Highlight the date/time option with the scroll buttons and press the display/enter button to continue.

Use the scroll buttons (3) to select the clock option. Press the display/enter button (4) to display the date/time setting screen.

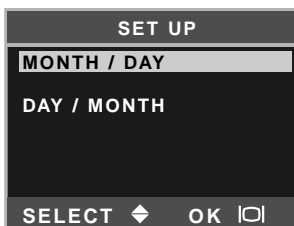

Use the flash-mode/copy button (5) to select the item to be changed. Use the scroll buttons (3) to adjust the item.



Pressing the white-balance/delete button (6) will close the screen and cancel any changes made.

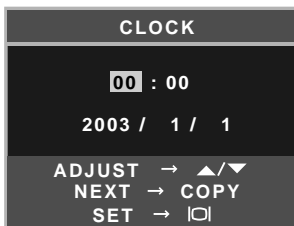

When the correct date and time is displayed, press the display/ enter button (4) to set the clock and calendar.

Image storage

This camera has an 8MB internal memory where the image can be stored without the need for a separate a memory card. To switch between the internal memory and a memory card, see pages 38 and 45.

The LCD monitor shows where the images will be stored. "IN" indicates the internal memory and "EX" indicates an external memory card.

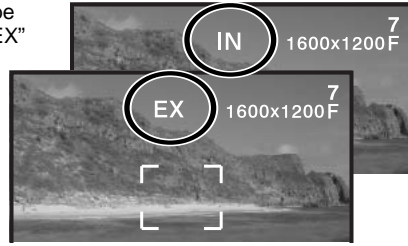

An SD Memory Card or MultiMediaCard, sold separately, can be inserted in the camera for image storage.

Always turn off the camera and confirm the indicator lamp is not lit before removing a memory card; damage and data loss may result.

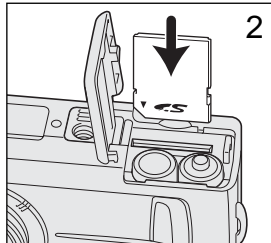
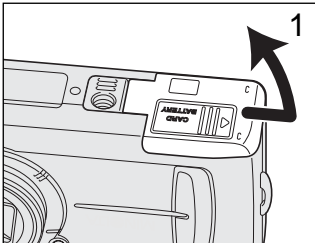
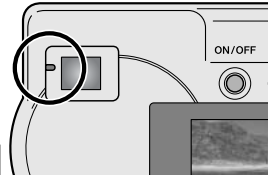

Open the card-slot door (1).

Insert the memory card all the way into the card slot until it stops (2). Insert the card so the face is toward the front of the camera. Always push the card in straight. Never force the card. If the card does not fit, check that it is oriented correctly.

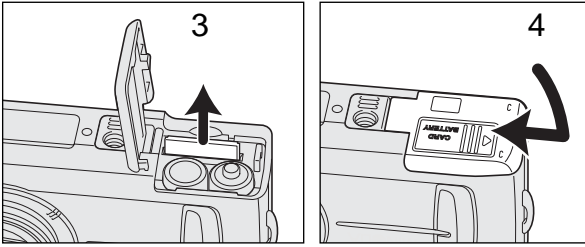

To remove a memory card, hold the edge of the card and pull it out straight (3). Take care when removing the card as it becomes hot with use.

Close the card-chamber door and slide it toward the body (4) to engage the safety catch.

If the card-protect message appears, the inserted card in the camera is locked. The card's write-protect switch must be in the unlock position to use the card. If the memory-card-error message appears, the inserted card may need to be formatted, or may not be compatible with this camera. To format the memory card, see pages 38 and 40. A card used in another camera may have to be formatted before being used. See the card's manual for details on card use.

Images are not transferred automatically to the memory card from internal memory when a memory card is inserted. To copy the data, see page 36.

Viewfinder

Because the optical viewfinder and the lens are slightly separated, the image seen through one is not exactly the same as the other; this is called parallax. Parallax can cause errors in framing at close distances and is more pronounced at longer focal lengths. When the subject is closer than 0.4m (1.3ft) in the macro mode, the use of the LCD monitor is recommended because it does not suffer from parallax. If the viewfinder is used, point the camera slightly upwards so that the top of the image is aligned with the close-framing guide.

Close-framing guide

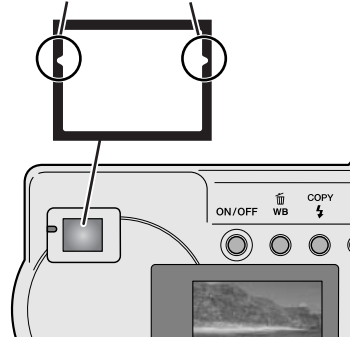

Handling the camera

While using the viewfinder or LCD monitor, grip the camera firmly with your right hand while supporting the body with your left. Keep your elbows at your side and your feet shoulder-width apart to hold the camera steadily.

When taking vertical pictures, hold the camera so that the flash is above the lens with the grip to the top. Take care not to cover the lens with your fingers or the strap.

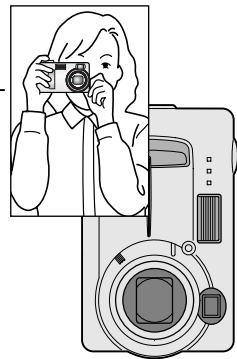

Indicator lamp

The indicator lamp glows green when the camera is turned on. When the shutter-release button is pressed partway down, it shows the focus and flash status. See page 22 for the details.

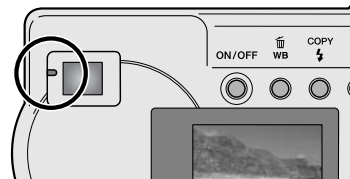

Using the zoom lens

This camera is equipped with a 6.2 to 18.6mm optical zoom. This is equivalent to a 38 to 114mm zoom lens on a 35mm camera. In 35mm photography, focal lengths below 50mm are referred to as wide-angle; the angle of view is larger than that of the human eye. Above 50mm is referred to as telephoto and makes distant objects appear closer. The effect of the optical zoom is visible in both the viewfinder and LCD monitor.



The zoom lens is operated by the zoom lever. Pressing the right side (T) will zoom in to the telephoto position of the lens. Pressing the left side (W) will zoom out to the wide-angle position. The optical zoom position is indicated by the lower white section of the zoom scale in the LCD monitor.

If the zoom lever is pressed toward the telephoto position at the telephoto position of the optical zoom, the digital zoom will activate; this is indicated by the upper red section of the zoom scale. The digital zoom extends the power of the telephoto position of the optical zoom by up to 3X in 0.2X increments. When the digital zoom is active, the image magnification is displayed on the monitor.

Digital zoom images are interpolated to the set image size. There can be some loss of quality with images taken with the digital zoom.

Digital zoom magnification

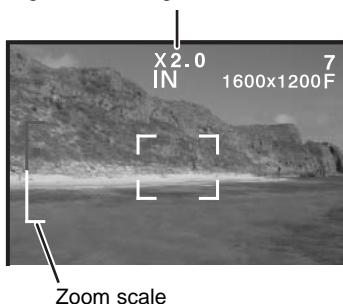

Basic recording operation

Turn the camera on (1) and turn the mode dial to the auto-recording mode (2).

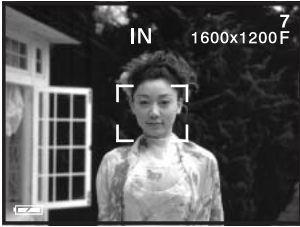
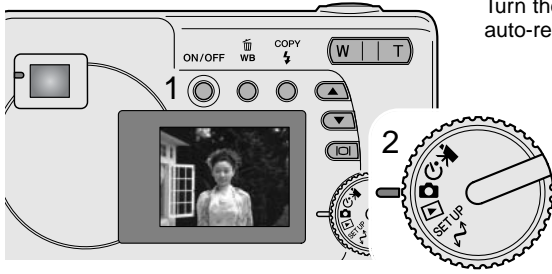

Place the subject within the focus frame.

- Make sure the subject is within the focus range of the lens: 0.6m - ∞ (2.0ft - ∞). For subjects closer than 0.6m, use the macro function (p. 33).

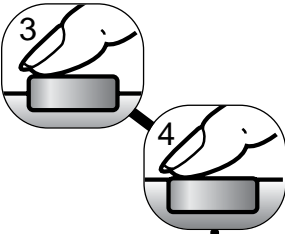

Press the shutter-release button partway down (3) to lock onto the subject and fix the exposure.

- The indicator lamp shows the status of focus and flash. See page 22 for the details.
- The focus frame turns red to confirm subject lock. If it remains white, the camera was unable to focus the subject. Repeat the previous steps.
- The shutter speed and aperture will appear indicating the exposure is locked.

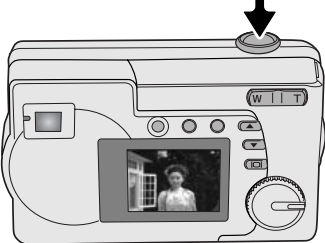

Press the shutter-release button all the way down (4) to take the picture.

- The green indicator lamp may blink indicating image data is being written to the memory card. Never turn the camera off or open the battery/card chamber door while data is being transferred.

Indicator lamp

When the camera is on, the indicator lamp shows the camera status.

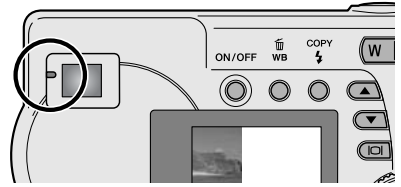

	When shutter-release button is not pressed	While shutter-release button is pressed partway down
Green and steady	Camera is on.	Focus is locked. Flash will not fire. The camera is ready to take the picture.
Orange and steady	—	Focus is locked. Flash will fire. The camera is ready to take the picture.
Green and blinks	Image data is being transferred to the card.	Cannot focus. Flash will not fire.
Orange and blinks	Flash is charging. LCD monitor is off.	Cannot focus. Flash will fire.

The shutter can be released when the camera cannot focus on the subject, the subject is too close, or a special situation is preventing the AF system from focusing. If the subject is too close, the indicator lamp may glow, but the subject will not be in focus.

Focus lock

The focus-lock function is used when you want to compose the image with the subject off-center and outside the focus frame. Focus lock may also be used when a special focusing situation prevents the camera from focusing on the subject. This function is controlled with the shutter-release button.



Place the subject within the monitor focus frame or center the subject in the viewfinder. Press and hold the shutter-release button partway down to lock the focus.

- The indicator lamp glows steadily and the focus frame turns red when the focus is locked.



Without lifting your finger from the shutter-release button, recompose the subject within the image area. Press the shutter-release button all the way down to take the picture.

Special focusing situations

The camera may not be able to focus in certain situations. If the autofocus system cannot focus on a subject, the indicator lamp blinks and the focus frame will not turn red. In this situation, focus-lock can be used to focus on an object at the same distance as the main subject and then the image can be recomposed on the monitor (p. 22).



The subject is too dark.

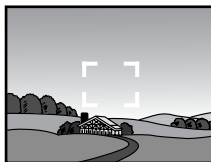

The subject in the focus frame is low in contrast.



Two subjects at different distances overlap in the focus frame.



The subject is near a very bright object or area.

Display button - playback mode

Pressing the display/enter button in the playback mode switches between the full display and the image-only display.

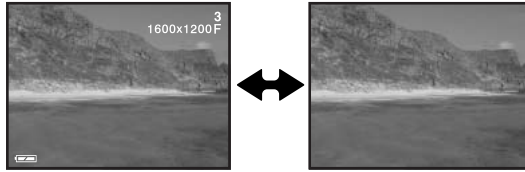
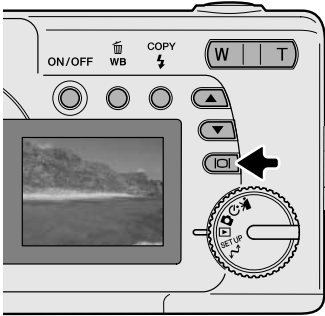

Deleting images

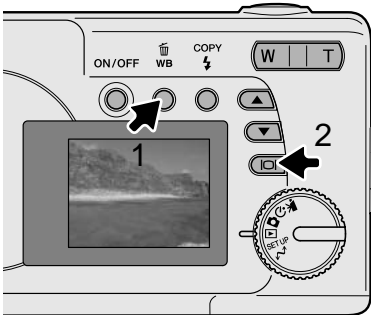

To delete the displayed image, press the white-balance/delete button (1). A confirmation screen will appear.



Press the display/enter button (2) to delete the image, or press any other button to cancel the delete operation.

AUTO-RECORDING MODE

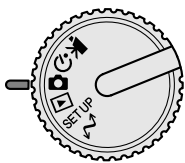

This section covers the operation in auto-recording mode. The sophisticated technology employed in this mode frees the photographer from complicated camera settings. Although automated, the camera's operation can be changed to meet various conditions as well as to suit personal shooting preferences.

Flash modes

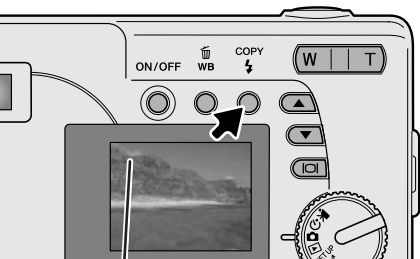

To set the flash mode, simply press the flash-mode/copy button on the back of the camera until the appropriate mode is indicated.

Autoflash - the flash fires automatically in low-light situations. If the flash will fire, the flash indicator will appear on the LCD monitor when the shutter-release button is pressed partway down.

Fill-flash - the flash fires with each exposure regardless of the amount of ambient light. Fill-flash can be used to reduce harsh shadows caused by strong direct light or sunshine.

Red-eye reduction - multiple flashes are used before the main flash burst to reduce red-eye; an effect caused by light reflected from the retina. Use in low-light conditions when taking photographs of people or animals. The pre-flashes contract the pupils of the subject's eyes.

Flash cancel - the flash will not fire. Use flash cancel when flash photography is prohibited, natural light is desired to illuminate the subject, or the subject is beyond the flash range.

No Indicator	Autoflash
⚡	Fill-flash
👁️ AUTO	Autoflash with red-eye reduction
⚡/🚫	Flash cancel

Flash range

The camera will automatically control the flash output. For well-exposed images, the subject must be within the flash range.

Flash range 0.6m ~ 2.5m (2.0 ft. ~ 8.2 ft.)

Display button - recording mode

The display button controls the LCD monitor display. The display cycles to the next position each time the button is pressed: full, simple, and monitor off.

Battery power can be conserved by turning the monitor off and using the viewfinder to take pictures. When the digital zoom is active, the monitor will automatically turn on and cannot be turned off.

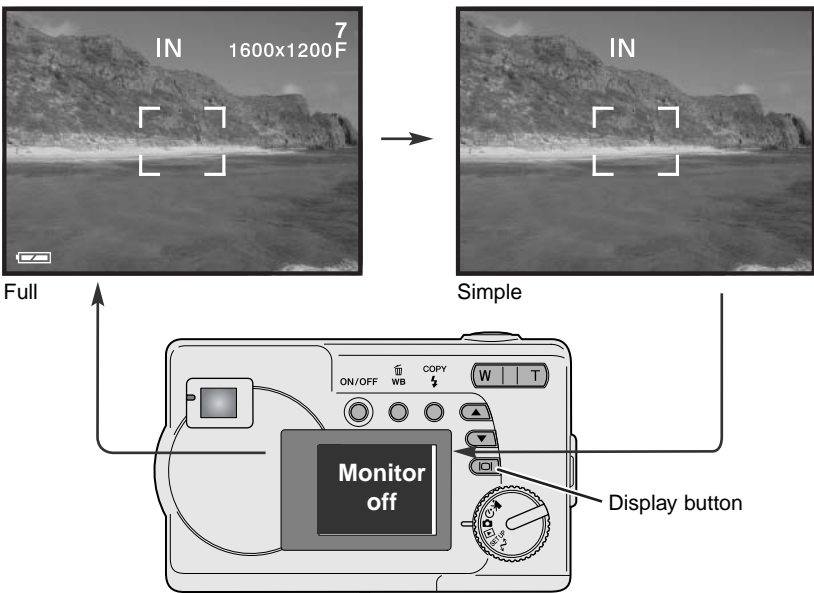

Sometimes the camera's exposure meter is deceived by certain conditions. Exposure compensation can be used in these situations. For example, a very bright scene, such as a snowy landscape or a white sandy beach, can appear too dark in the captured image. Before taking the picture, adjusting the exposure by +1 or +2 EV will result in an image with normal tonal values.

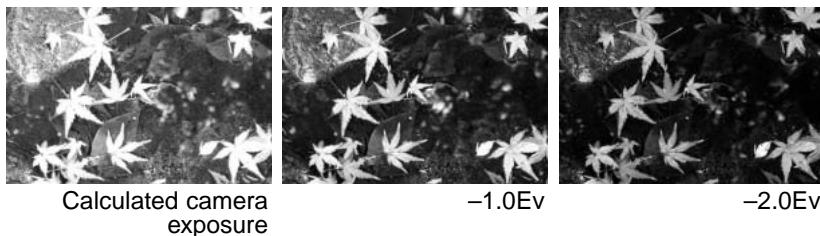

In the example above, the dark water caused the camera to overexpose the image making it bright and washed-out. By compensating the exposure, detail is brought out in the leaves, and the stones and water appear richer.

What is an Ev? What is a stop?

Ev stands for exposure value. The term stop comes from the name of aperture plates used in early lenses. A change of one Ev or one stop will adjust the exposure calculated by the camera by a factor of two.

Change in Ev	Change in stops	Adjustment to exposure
+2.0 Ev	+2 stops	4X as much light
+1.0 Ev	+1 stop	2X as much light
0.0 Ev	Calculated exposure	
-1.0 Ev	-1 stop	1/2 as much light
-2.0 Ev	-2 stops	1/4 as much light

White balance

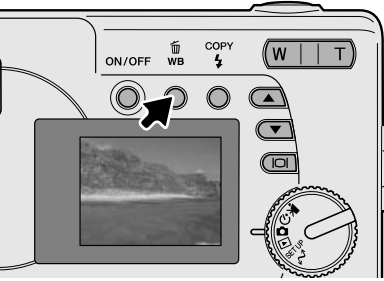

White balance is the camera's ability to make different types of lighting appear neutral. The effect is similar to selecting daylight or tungsten film, or using color compensating filters in conventional photography. An indicator will be displayed on the monitor if a setting other than auto white-balance is chosen. White balance is set by pressing the white-balance/delete button. Each time the button is pressed, the white balance mode cycles in the following order: Automatic, Daylight, Cloudy, Tungsten, and Fluorescent.





Automatic white balance

The automatic white balance compensates for the color temperature of a scene. In most cases, the auto setting will balance the ambient light and create beautiful images, even under mixed-lighting conditions. When the built-in flash is used, the white balance is set for the color temperature of the flash. No indicator is displayed for automatic white balance.

Preset white balance

Preset white-balance settings must be set before the image is taken. Once set, the effect is immediately visible on the LCD monitor.

If the flash is used, white balance is automatically set to the color temperature of the flash. Use flash cancel to prevent the flash from firing.

-  **Daylight** - for outdoor and sunlit subjects.
-  **Cloudy** - for overcast outdoor scenes.
-  **Tungsten** - for incandescent lighting: household filament light bulbs.
-  **Fluorescent** - for fluorescent lighting: office ceiling lights.

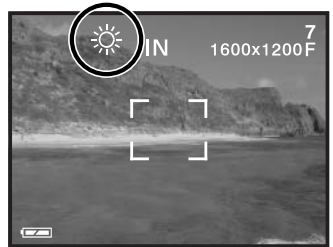

MOVIE-RECORDING MODE

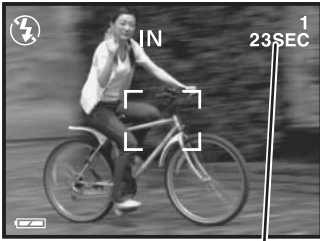

Recording time

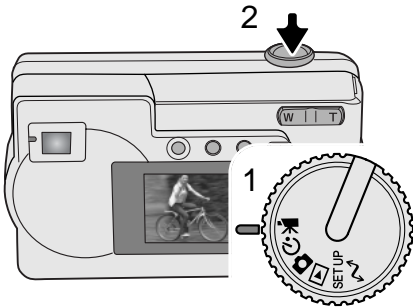

Shooting digital video is simple. Set the mode dial to movie recording (1). Frame the picture and press the shutter-release button (2) all the way down and release to start recording.

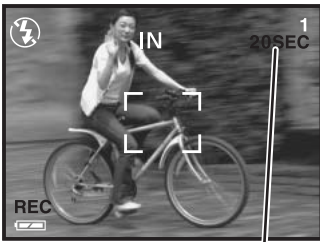

Countdown in seconds

During recording, the digital zoom is available; the optical zoom can only be adjusted before recording starts. The camera will continue to record until the recording time is used or the shutter-release button is pressed again. When recording, the frame counter will count down the remaining time.

PROGRAM-RECORDING MODE

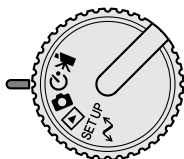

In the program-recording mode, various subject programs are available including a self-timer and macro mode. Except for exposure compensation, the function in the auto-recording mode are available in the program-recording mode.

Turn the camera on and turn the mode dial to the program-recording mode.

Use the scroll-down button to cycle through the program modes as shown. The scroll-up button will change the modes in reverse order.

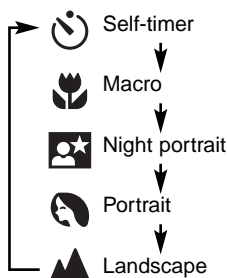
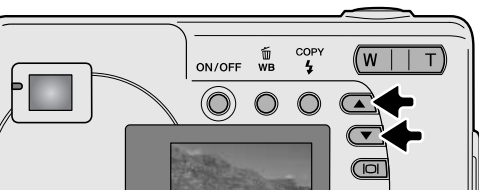

Self-timer

Used for self-portraits, the self-timer will delay the release of the shutter for approximately ten seconds after the shutter-release button is pressed. With the camera on a tripod, compose the picture so the subject is within the focus frames. Press the shutter-release button partway down to lock the exposure and focus (1). Press the shutter-release button all the way down to begin the countdown (2). Because focus and exposure are determined when the shutter-release button is pressed, do not stand in front of the camera when taking a self-timer image. Always confirm the focus with the red focus frame before beginning the countdown (p. 21).

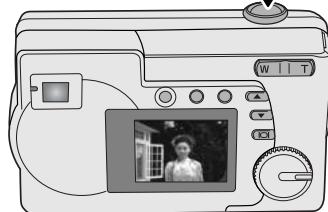
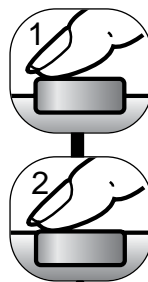

During the countdown, the self-timer lamp on the front of the camera (3) will start to blink and is accompanied by an audio signal if on. A few seconds before the exposure, the self-timer lamp will blink rapidly. Changing the position of the mode dial or pressing the shutter-release button will stop the countdown.

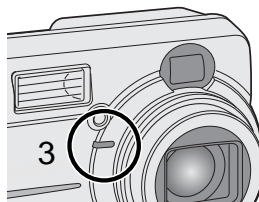

Macro



Used for close-up photography between 8 - 60 cm (3.2 - 24 in.) at the wide-angle zoom position and 40 - 60 cm (16 - 24 in.) at the telephoto zoom position, from the camera lens. Because of parallax, the LCD monitor or close-framing guide should be used to compose the picture. Use of flash is not recommended.

Night portrait



The flash and ambient exposures are balanced to reveal the subject and background in low light. Ask your subject not to move after the flash burst; the shutter may still be open for the background exposure. The flash mode is set to fill-flash automatically; to take pictures of landscapes at night, set the flash mode to flash cancel (p. 26). The use of a tripod is recommended.

Portrait



For pictures of people. Most portraits look best at a telephoto setting; longer focal lengths do not exaggerate facial features and the shallower depth of field softens the background. The flash mode is set to autoflash automatically, but can be changed.

Landscape



For pictures of scenery. The flash mode is set to flash cancel and white balance is set to daylight automatically, but can be changed.

PLAYBACK MODE

The basic functions in this mode are described on pages 24 and 25. This section covers the advanced functions of this mode.

Index playback

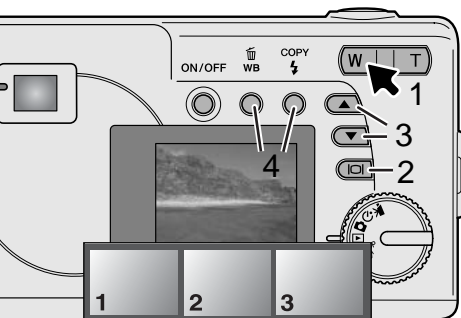

In the playback mode, pressing the left side (W) of the zoom lever (1) will change the LCD monitor display from single-frame playback to a nine-frame index playback display. The monitor will return to single-frame playback if either side of the zoom lever is pressed again.

In index playback, pressing the display/enter button (2) will turn the image-selection frame on or off. When frame is not displayed, pressing the scroll buttons (3) shows the next or previous nine images.

When frame is displayed, specific images can be selected. To move the frame up and down, press the scroll buttons (3). Use the white-balance/delete button and flash-mode/copy button to move the frame left and right (4).

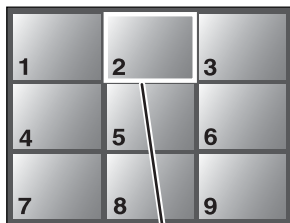
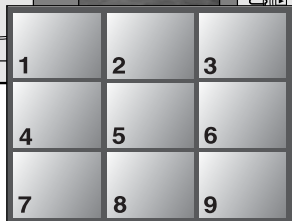
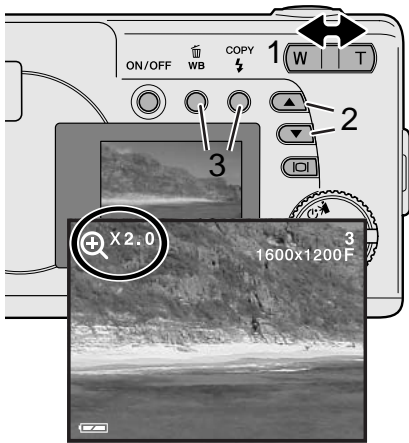

Image-selection frame

Enlarged playback



In the playback mode, a still image can be enlarged up to 4X in 0.5 increments for closer examination.

With the image to be magnified displayed, press the right side (T) of the zoom lever (1) to activate the enlarged playback mode. The degree of magnification is displayed on the LCD monitor. Use the zoom lever (1) to increase or decrease the magnification.

To scroll the enlarged image up and down, press scroll buttons (2). To scroll left and right, use white-balance/delete and flash-mode/copy buttons (3).

Playing back movies



To play back movie clips, use the scroll buttons to display the movie file.

Press the shutter-release button (1) to play back the displayed movie file.

Press the shutter-release button again to pause the movie; press it again to resume the playback. The movie repeats until the shutter-release button is pressed or another image is selected with the scroll buttons.



Press the display button (2) to view the movie with or without the guidance bar.

Image copy

Images are stored either in the 8MB internal memory or in a memory card. Stored images can be copied between the internal memory and a memory card. The copy function makes exact copies of still image or movie files. DPOF settings are not copied with image files. Files are copied from the selected memory. To switch between the internal memory and a memory card, see pages 38 and 45.

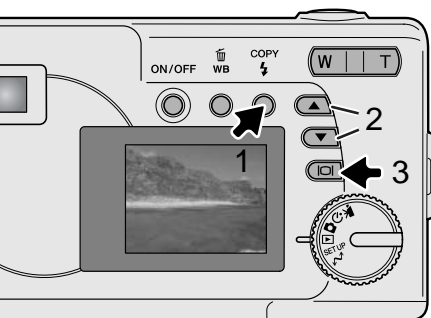

To copy image files, press the flash-mode/copy button (1).



Press the copy button (1) to select either the one image or all images option. The one image option only copies the displayed image; use the scroll buttons (2) to display the image to be copied. If the all images option is selected, all the image files in the internal memory or card will be copied.

To execute the copy command, press the display/enter button (3).

If the amount of data exceeds the memory capacity of the location it is being copied to, the memory-full message appears. Decrease the number of the images to be copied or delete unnecessary images to create space.

Viewing images on a television

It is possible to view camera images on your television. The camera has a video-out terminal to make the connection using the supplied Video cable. The camera is compatible with the NTSC and PAL standards. The video-output setting can be checked and set in the setup mode (p. 38).

1. Turn off the television and the camera.

2. Insert the mini-plug end of the Video cable into the camera's video-out terminal.

3. Plug the yellow end of the Video cable into the video input terminals on the television.

4. Turn the television on.

5. Change the television to the video channel.

6. Turn the camera's mode dial to the playback position and turn the camera on. The camera's monitor will not activate when the camera is attached to a television. The playback-mode display will be visible on the television screen.

7. View images as described in the playback section.

- The movie clip's audio track will be played back on the camera.

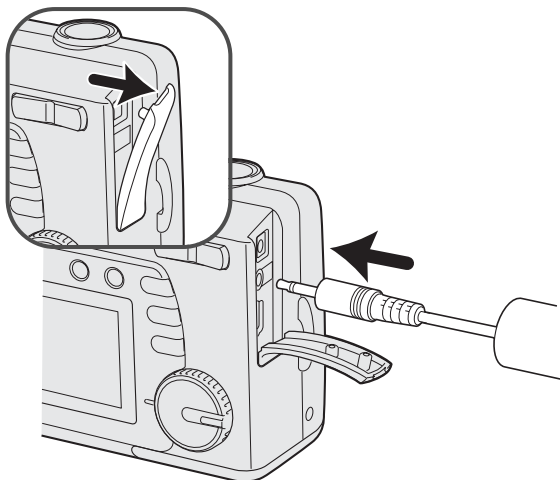

SETUP MODE

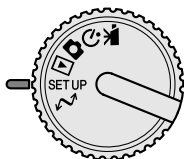

The setup mode is used to control the camera's functions and operation. The navigating the setup menu section covers the operation of the menu. The section is followed by detailed descriptions of the settings.

Navigating the setup menu

To access the menu, simply turn the mode dial to the setup position. The scroll buttons are used to move the cursor in the menu. Pressing the display/enter button will select a highlighted option.

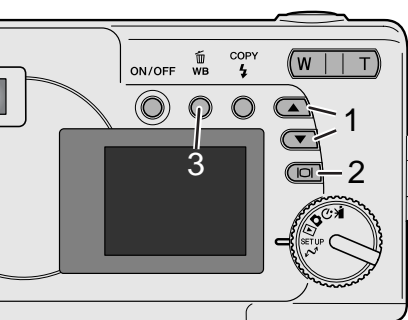

With the setup mode is selected in the mode dial, use the scroll buttons (1) to scroll through the menu options. The second half of the menu will appear after scroll past the last option displayed. Highlight the option whose setting needs to be changed.



With the menu option to be changed highlighted, press the display/enter button (2); the settings will be displayed with the current setting highlighted. To return to the menu options, press the white-balance/delete button (3).



Use the scroll buttons (1) to highlight the new setting.



Press the display/enter button (2) to select the highlighted setting.

Once a setting has been selected, the cursor will return to the menu options. Setting can continue to be made.

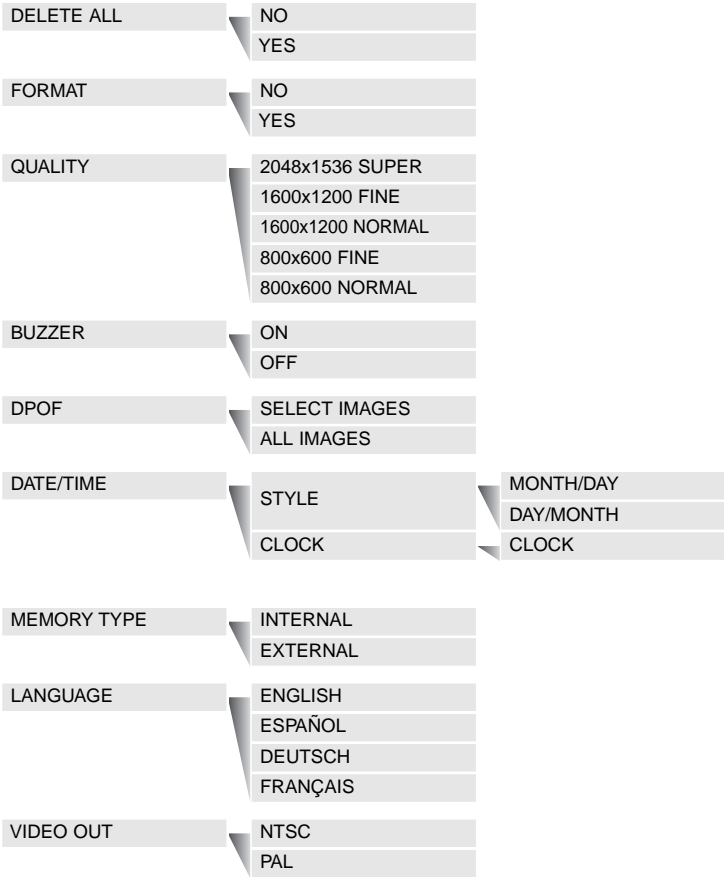

Deleting all images



Deleting permanently erases the file. Once deleted, a file cannot be recovered. Care should be taken when deleting images.

All the images in either the internal memory or a memory card can be deleted at once. The internal memory or the memory card must be selected with the setup menu first. See navigating the setup menu section on page 38.

When the delete-all option is selected, choosing “Yes” and pressing the display/enter button immediately deletes all the images.

Format



When a memory card or internal memory is formatted, all data is erased.

The formatting function is used to erase all data in either a memory card or the internal memory. Before formatting, copy the data to a computer or storage device. Always format the memory card using the camera; never use a computer to format the camera or card.

The internal memory or the memory card must be selected with the setup menu first. See navigating the setup menu section on page 38. When the format option is selected, choosing “Yes” and pressing the display/enter button immediately formats the card or internal memory and erases all images.

If the memory-card-error message appears, the inserted card in the camera may need to be formatted. A memory card used in another camera may also have to be formatted before being used.

Image quality

Image quality is based on two factors: image size and compression rate.

Image size is the pixel dimensions of the image such as 1600 x 1200 pixels. The greater the image size, the larger the file size. Choose image size based on the final use of the image - smaller images will be more suitable for web sites whereas larger sizes will produce higher quality prints.

All images are compressed and saved as JPEG files. The compression rate is indicated by FINE, NORMAL, and SUPER. FINE images have the lowest compression rate and the largest file size. NORMAL is sufficient for standard use. 2048x1536 SUPER quality creates the largest images for prints, but because the image size is interpolated and the compression rate is high, some loss of image quality may be noticed.

Image quality must be set before the picture is taken. Changes are displayed on the LCD monitor. See navigating the setup menu section on page 38 to select the quality option.

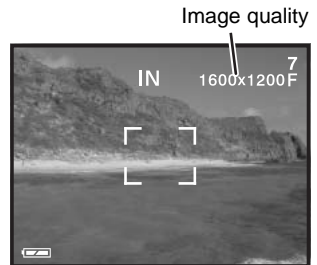

If quality is changed, the frame counter will display the approximate number of images that can be recorded at that setting. Images with differing qualities can be saved in the same memory location. The number of images that can be stored is determined by the size of the memory and the file size of the images. The actual file size is determined by the scene; some subjects can be compressed further than others.

Quality	Approximate file sizes	Approximate number of images that can be stored	
		8MB SD memory card	8MB internal memory
2048x1536 SUPER	768KB	7	7
1600x1200 FINE	853KB	6	7
1600x1200 NORMAL	640KB	14	16
800x600 FINE	213KB	25	27
800x600 NORMAL	160KB	55	60

Camera Notes

The frame counter indicates the approximate number of images that can be stored in either the internal memory or the memory card at the camera's image quality setting. If the settings are changed, the frame counter adjusts accordingly. Because the counter uses approximate file sizes, the actual image taken may not change the counter or may decrease it by more than one. When the frame counter displays zero, it indicates no more images at the image quality setting can be captured. Changing those settings may allow more images to be saved to the card.

Buzzer

Every time a button is pressed, an audio signal will give a positive confirmation of the operation. The audio signals can be turned off. See navigating the setup menu section on page 38 to select the buzzer option.

About DPOF

This camera is supported by DPOF™ version 1.1. The DPOF (Digital Print Order Format) allows direct printing of still images from digital cameras. After the DPOF file is created on a memory card, the card is simply taken to a photofinishing service or inserted into the memory-card slot of DPOF compatible printers. When a DPOF file is created, a misc. folder is automatically created (p. 52). Only a DPOF file created on a memory card can be used for printing.

Creating a DPOF Print Order

The print menu option is used to set an order for standard prints from still images on the memory card. Single, multiple, or all images can be printed. Date imprinting can also be set. See navigating the setup menu section on page 38.



When the DPOF-setting screen appears, use the scroll buttons to choose the select-images option to create a DPOF file for single or multiple images, or the all-images option to create a DPOF file for all images on the memory card. Press the display/enter button to enter the setting.



When the select-images option is chosen, the print-order screen appears. Use the scroll buttons to select the image to be printed.



When the image is displayed, press the copy button. The copies option is highlighted.

Use the scroll buttons to select the number of prints for the displayed image.



Press the copy button. The date option is highlighted.

Choose "Yes" or "No" using the scroll buttons. "Yes" will print the date and time of recording next to the image. The date option cannot be set if the number of copies is 0.

Every time the copy button is pressed, the functions cycle among selecting images, the number of copies, and date imprinting. Continue until all the images to be printed are selected. Pressing the delete button will cancel the DPOF setting screen and any changes made.



With all the images to be printed selected, press the display/enter button to enter the settings.

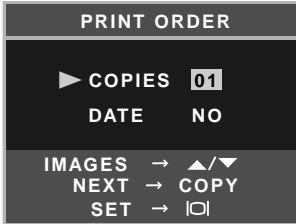

When the all-images option is chosen on page 43, the print-order screen for all images appears. Use the scroll buttons to select the number of copies for all the images on the memory card.



Press the copy button to set the date and time as described above, if required.

COPY



With all the images to be printed selected, press the display/enter button to enter the settings.

If the all-frames setting was used to create a print order, any additional images recorded afterwards will not be included in the order.

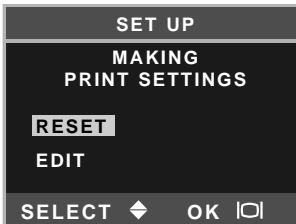

If a DPOF order has already been created, the print-setting screen will open. The reset option cancels all print settings and allows new settings to be made. The edit option allows the current settings to be changed.

DPOF files created with another camera will be canceled. After the pictures have been printed, the DPOF file will still remain on the memory card and must be canceled manually. Some printer may not recognize the date setting and not print the information.

Setting the date and time

See page 14 to set the date and time.

Memory type

This camera stores images in either the 8MB internal memory or a separate SD Memory Card or MultiMediaCard.

Memory type affects all the camera operations. If “Internal” (internal memory) is selected, the images will be stored in the internal memory in the recording modes, and playback, format, and delete-all functions will be executed only for the images in the internal memory. If “External” (memory card) is selected, all the images will be stored in the card, and all the functions will be executed for the card only.

Aln the recording mode, the LCD monitor shows the current memory in use. “IN” indicates the internal memory and “EX” indicates the external memory card.

When a memory card is inserted, the setting changes to “External” automatically, but can be changed if necessary. Always confirm the memory type before taking pictures.

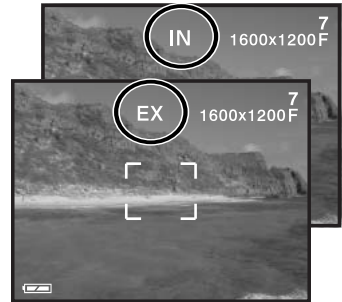

Language

The language used in the menus can be changed. See page 14.

Video output

Camera images can be displayed on a television (p. 37). The video output can be changed between NTSC and PAL. North America uses the NTSC standard and Europe uses the PAL standard. Check which standard is used in your region to play back images on your television set.

DATA-TRANSFER MODE

Read this section carefully before connecting the camera to a computer. Instructions on using and installing the DiMAGE Viewer software are found in the supplied software manual. The DiMAGE manuals do not cover the basic operation of computers or their operating systems; please refer to the manual supplied with your computer.

System requirements

For the camera to be connected directly to the computer and used as a mass-storage device, the computer must be equipped with a USB port as a standard interface. Both the computer and the operating system must be guaranteed by their manufacturers to support USB interface. The following operating systems are compatible with the camera:

IBM PC / AT Compatible

Windows 98, 98SE, Me,
2000 Professional, and XP.

Macintosh

Mac OS 9.0 ~ 9.2.2,
Mac OS X v10.1.3 ~ 10.1.5, and v10.2.1 ~
10.2.3

Check the Minolta web site for the latest compatibility information:

North America: <http://www.minoltausa.com>

Europe: <http://www.minoltasupport.com>

Users with Windows 98 or 98 second edition will need to install the driver software on the included DiMAGE Viewer CD-ROM (p. 49). No special driver software is required for other Windows or Macintosh operating systems.

Customers who have bought a previous DiMAGE digital camera and have installed the Windows 98 driver software must repeat the installation procedure. The updated version of the driver software included on the supplied DiMAGE Viewer CD-ROM is required for the operation of the DiMAGE E223 with a computer. The new software will have no affect on the performance of older DiMAGE cameras.

Connecting the camera to a computer

Confirm the battery has sufficient power before connecting the camera to a computer, the full-battery indicator should be displayed on the monitor. The auto power off function is disabled when the camera is connected to a computer. The use of the AC adapter (sold separately) is recommended over the use of the battery. For users with Windows 98 or 98SE, read the section on how to install the required USB driver before connecting the camera to a computer (p. 49).

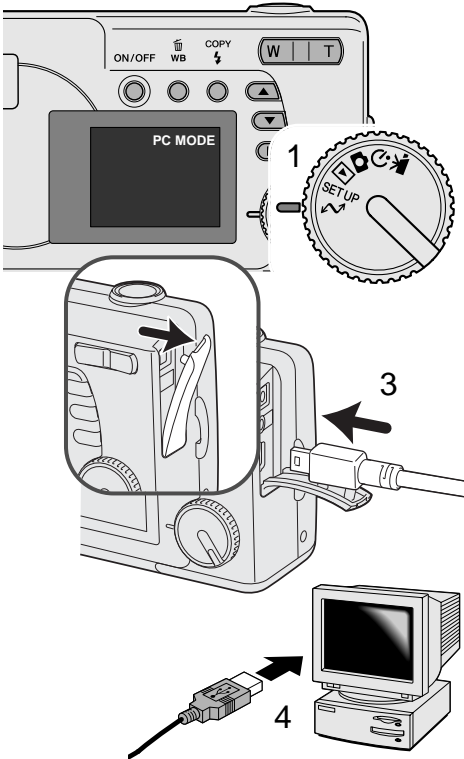

1. The memory-type option in the setup mode must be set to the storage location of the images (p. 38 and 45). Turn the mode dial to the data transfer position.

2. Start up the computer. The computer must be on before connecting the camera.

3. Open the terminal cover. Attach the smaller plug of the USB cable to the camera. Make sure the plug is firmly attached.

4. Attach the other end of the USB cable to the computer's USB port. Make sure the plug is firmly attached.

- The camera should be connected directly to the computer's USB port. Attaching the camera to a USB hub may prevent the camera from operating properly.
- When the camera is connected to a computer, the LCD monitor is off.



Windows XP

When the camera is properly connected to the computer, a drive icon, or volume, will appear. When using Windows XP or Mac OS X, a window will open requesting instructions on what to do with the image data; follow the directions in the window. If the computer does not recognize the camera, disconnect the camera and restart the computer. Repeat the connection procedure above.



Mac OS X



Windows



Mac OS X

Mac OS

The volume name varies between memory cards.

Connecting to Windows 98 and 98 Second Edition

The USB driver is required for Windows 98 and 98 Second Edition. No special driver software is required for other Windows or Macintosh operating systems.

During installation, if the operating system requests the Windows 98 CD-ROM, insert it into the CD-ROM drive and follow the accompanying instructions on the screen.

To install the Windows 98 driver, follow the instructions in the connecting-the-camera-to-a-computer section on page 47.

When the camera is plugged into the computer, the operating system will detect the new device and the add-new-hardware-wizard window will open. Place the DiMAGE Viewer CD-ROM in the CD-ROM drive. Click “Next.”



Choose the recommended search for a suitable driver. Click “Next.”

Choose to search for the driver in the CD-ROM drive. Click “Next.”

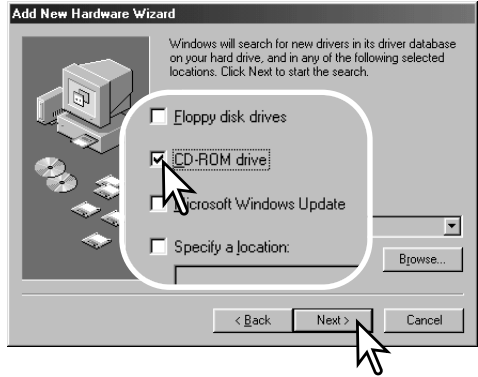

The add new hardware wizard will confirm the location of the driver. Click “Next” to install the driver in the system.

- The letter designating the CD-ROM drive will vary between computers.

The last window will confirm the driver has been installed. Click “Finish” to close the add new hardware wizard. Restart the computer.



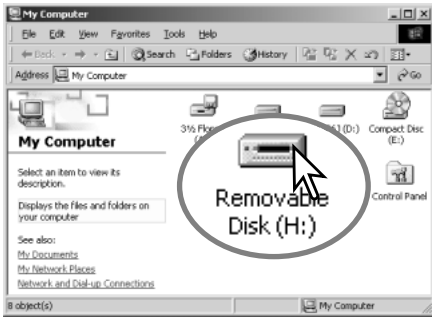

When the my-computer window is opened, a new removable-disk icon will be displayed. Double click on the icon to access the camera's internal memory or memory card; see page 48.

QuickTime system requirements

IBM PC / AT Compatible

Pentium-based computer

Windows 95, 98, 98SE, NT, Me,
2000 Professional, or XP.

32MB or more of RAM

Sound Blaster or compatible sound card

DirectX 3.0 or later recommended

To install QuickTime, follow the instructions in the installer. Macintosh users can download the latest version of QuickTime free of charge from the Apple Computer web site: <http://www.apple.com>

Auto power save (data-transfer mode)

If the camera does not receive a read or write command within 30 minutes, it will shut down to save power. When the camera shuts down, an unsafe-removal-of-device warning may appear on the computer monitor. Click "OK." Neither the camera or computer will be damaged in this operation.

Turn off the camera. Remake the USB connection by turning on the camera.

Memory card folder organization

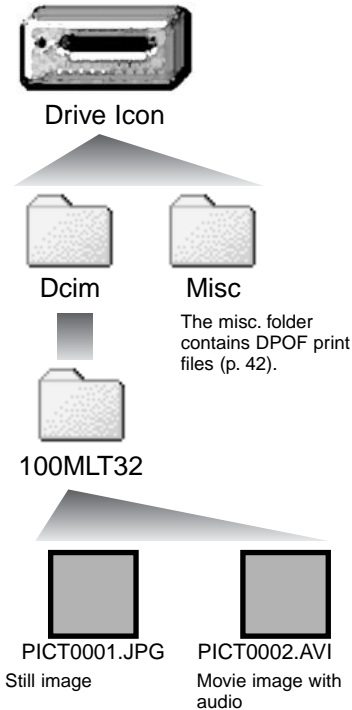

Once the camera is connected to the computer, image files can be accessed by double clicking on icons. Image folders are located in the DCIM folder. To copy images, simply drag and drop the file icon into a location in the computer. Files and folders in the internal memory or memory card can be deleted using the computer. Never format the internal memory nor memory card from the computer; always use the camera to format the memory. Only files recorded by the camera should be stored in the internal memory or memory card.

Image and movie file names begin with "PICT" followed by a four-digit file number and a jpg or avi extension.

If the all-images copy function (p. 36) is used, a new folder is created. When a folder is created, the first three digits in the folder name will be one greater than the largest folder number on the card. When the index number in the image file name exceeds 9,999, a new folder will be created with a number one greater than the greatest folder number on the memory card: e.g. from 100MLT32 to 101MLT32.

The number in the image file name may not correspond to the frame number of the image. As images are deleted in the camera, the frame counter will adjust itself to show the number of images on the card and reassign the frame numbers accordingly. The serial numbers used with image files will not change when an image is deleted. When a new image is recorded, it will be assigned a number one greater than the largest serial number in the folder.

Camera Notes

Image files contain exif tag data. This data includes the time and date the image was recorded as well as the camera settings used. This data can be viewed with the camera or the DiIMAGE Viewer software. If a camera image is opened in a photo-retouching application like Adobe Photoshop, and then the image is saved overwriting the original data, the exif tag information is erased. When using software other than the DiIMAGE Viewer, always make a backup copy of the image files to protect the exif tag data.

Uninstalling the driver software - Windows

1. Connect the camera to the computer with the USB cable. Other devices must not be connected to the computer during this procedure.

2. Right click on the My-computer icon. Select "properties" from the drop-down menu.

Windows XP: from the start menu go to the control panel. Click on the performance and maintenance category. Click "System" to open the system properties window.

3. Windows 2000 and XP: select the hardware tab in the properties window and click the device-manager button.

Windows 98 and Me: click the device-manager tab in the properties window.

4. The driver file will be located in the universal-serial-bus-controller or other-devices location of the device manager. Click on the locations to display the files. The driver should be indicated with the camera name. Under certain conditions, the driver name may not contain the camera name. However, the driver will be indicated by either a question mark or exclamation point.

5. Click on the driver to select it.

6. Windows 2000 and XP: click on the action button to display the drop-down menu. Select "uninstall." A confirmation screen will appear. Clicking "Yes" will remove the driver from the system.

Windows 98 and Me: click the remove button. A confirmation screen will appear. Clicking "Yes" will remove the driver from the system.

7. Disconnect the USB cable and turn off the camera. Restart the computer.

Disconnecting the camera from the computer

Follow the instruction below when disconnecting the camera from the computer. This procedure is also necessary before changing the memory type while the camera is connected to the computer. The appearance of screens may differ with the operating system.



Never disconnect the camera when the indicator lamp is blinking
- the data or memory card may permanently be damaged.

Windows 98 / 98 Second Edition

Confirm that the green indicator lamp is not blinking. Turn the camera off and then disconnect the USB cable.

Windows Me, 2000 Professional, and XP



To disconnect the camera, click once on the unplug-or-eject-hardware icon located on the task bar. A small window will open indicating the device to be stopped.



Click on the small window to stop the device. The safe-to-remove-hardware window will open. Close the window, turn the camera off, and then disconnect the USB cable.



When more than one external device are connected to the computer, repeat the procedure above except right click on the unplug-or-eject-hardware icon. This will open the unplug-or-eject-hardware window after clicking on the small window indicating the unplug-or-eject-hardware routine.



The hardware devices to be stopped will be displayed. Highlight the device by clicking on it then click "Stop."



A confirmation screen will appear to indicate the devices to be stopped. Clicking "OK" will stop the device.



A third and final screen will appear to indicate the camera can be safely disconnected from the computer. Close the window, turn the camera off, and then disconnect the USB cable.



Macintosh



Confirm that the green indicator lamp is not blinking and then drag the mass-storage device icon and drop it into the trash. Turn the camera off, and then disconnect the USB cable.



APPENDIX

Troubleshooting

The section covers minor problems with basic camera operation. For major problems or damage, or if a problem continues to reoccur frequently, contact a Minolta service facility listed on the back cover of this manual.

Problem	Cause	Solution
The camera will not work.	The battery is dead.	Replace battery (p. 11).
	AA Ni-MH batteries are exhausted.	Ni-MH batteries must be charged before use.
Memory-full message appears.	Selected memory is full and unable to store an image at the image-quality setting on the camera.	Change the memory type (p. 45), insert a new memory card (p. 16), delete some images (p. 25), or change the image-quality setting (p. 41).
Focus frame remains white and pictures are not sharp.	Subject is too close.	Make sure the subject is within the autofocus range (p. 21) or use the macro mode (p. 33).
	The camera is in macro mode.	Cancel the macro mode setting (p. 33).
	A special situation is preventing the autofocus system from focusing (p. 23).	Use the focus-lock function to focus on an object at the same distance as the subject (p. 22).
Pictures are not sharp in low-light situations.	Pictures are taken indoors or in low-light situations without flash. Slow shutter speeds result in blurred images when the camera is hand-held.	Use a tripod or use the flash (p. 26).

Problem	Cause	Solution
Monitor turns off and the orange indicator lamp blinks.	Flash is charging.	Wait until the monitor image is visible and the orange indicator lamp glows.
While using flash, the pictures are too dark.	The subject is beyond the flash range (p. 27).	Move closer to the subject.
Exposure-compensation display turns red.	Scene is too bright or dark and outside the exposure range of the camera.	Change the setting until the display is white.
No-image message appears in playback mode.	Different memory type is selected.	Select the memory type (internal memory or memory card) where the images were saved (p. 45).
Error or zoom-error message appears.	Remove and reinsert the batteries, or unplug and reconnect the AC adapter.	

If the camera does not function normally, turn it off, remove and reinsert the batteries, or unplug and reconnect the AC adapter. If the camera has become hot with extended use, wait for it to cool before removing or disconnecting the power supply. Always turn the camera off with the main switch, otherwise the memory card may be damaged and camera settings reset.

Care and storage

Read this section in its entirety to get the best results from your camera. With proper care, your camera will provide years of service.

Camera care

- Do not subject the camera to shock or impact.
- Turn off the camera when transporting.
- This camera is neither waterproof nor splashproof. Inserting or removing batteries or the memory card, or operating the camera with wet hands may damage the camera.
- When at the beach or near water, take care not to expose the camera to water or sand. Water, sand, dust, or salt can damage the camera.
- Do not leave the camera under direct sunlight. Do not point the lens directly at the sun; the CCD may be damaged.

Cleaning

- If the camera or the outside of the lens is dirty, gently wipe it with a soft, clean, dry cloth. If the camera or lens comes in contact with sand, gently blow away loose particles. Wiping may scratch the surface.
- To clean the lens surface, first blow away any dust or sand, then, if necessary, moisten a lens tissue or soft cloth with lens cleaning fluid and gently wipe the lens.
- Never use organic solvents to clean the camera.
- Never touch the lens surface with your fingers.

Storage

- Store in a cool, dry, well-ventilated area away from dust and chemicals. For long periods of disuse, store the camera in an airtight container with a silica-gel drying agent.
- Remove the batteries and memory card from the camera when not in use for extended periods.
- Do not store the camera in an area with naphthalene or mothballs.
- During long periods of storage, operate the camera occasionally. When taking the camera out of storage, check that the camera is functioning properly before using.

Operating temperatures and conditions

- This camera has been designed for use in temperatures from 0°C to 40°C (32°F to 104°F).
- Never leave the camera exposed to extreme high temperatures, such as in a car parked in the sun, or to extreme humidity.
- When taking the camera from a cold to a warm environment, place it in a sealed plastic bag to prevent condensation from forming. Allow the camera to come to room temperature before removing it from the bag.

Batteries

- Battery performance decreases with temperature. In cold environments, we recommend keeping spare batteries in a warm place, such as the inside of a coat. Batteries can recover their power when they warm up.
- If batteries have been exhausted when used in the camera, do not reload them even if their charge seems to recover over time. These batteries will interfere with normal camera operation.

Copyright

- TV program, films, video tapes, photographs, and other materials may be copyrighted. Unauthorized recording or duplication of such material may be contrary to copyright laws. Taking pictures or images of performances, exhibitions, etc., is prohibited without approval and can infringe on copyright. Images protected by copyright can only be used under the provisions within the copyright laws.

LCD monitor care

- Although the LCD monitor is manufactured using high precision technology, there may occasionally be a lack of color or bright points on the monitor.
- Do not apply pressure to the surface of the LCD monitor; it may be permanently damaged.
- In cold temperatures, the LCD monitor may become temporarily dark. When the camera warms up, the display will function normally.
- If fingerprints are on the LCD monitor surface, gently wipe with a soft, clean, dry cloth.

About Ni-MH batteries

When using Ni-MH batteries, clean both battery terminals with dry cloth to wipe off any dirt or residue. Because of the sophisticated computer system, the camera critically monitor power levels. If the battery terminals are dirty, the camera may give a false low-battery warning. If battery performance is unusually low, wipe the battery terminals with a clean, dry cloth.

Ni-MH battery performance will decrease if the batteries are often recharged before they have been fully discharged. Completely exhaust the Ni-MH batteries using the camera before charging.

About the DiMAGE Viewer

The flicker and image-correction functions on the correction menu in the Movie Enhancer cannot be used with Movie files captured with the DiMAGE E223. A computer system error will occur.

The following marks may be found on the product:



This mark on your camera certifies that this camera meets the requirements of the EU (European Union) concerning interference causing equipment regulations. CE stands for Conformité Européenne (European Conformity).

Digital Camera: DiMAGE E223



Tested To Comply
With FCC Standards

FOR HOME OR OFFICE USE

This device complies with Part 15 of the FCC Rules. Operation is subject to the following two conditions: (1) This device may not cause harmful interference, and (2) this device must accept any interference received, including interference that may cause undesired operation.

Do not remove the ferrite cores from the cables.
Tested by the Minolta Corporation
101 Williams Drive, Ramsey, New Jersey 07446,
U.S.A.

This Class B digital apparatus complies with Canadian ICES-003.

Cet appareil numérique de la classe B est conforme à la norme NMB-003 du Canada.

Technical specifications

Number of effective pixels:	2.0 million (approx.)
CCD:	1/2.7-type interline primary-color CCD
Camera sensitivity:	ISO 100 equivalent
Aspect ratio:	4:3
Lens construction:	9 elements in 6 groups
Focal length:	6.2 - 18.6mm (35mm equivalent: 38 - 114mm)
Maximum aperture:	f/2.9 - f/3.0
Focusing range:	Wide: 0.6m to infinity (from front of lens) Telephoto: 0.6m to infinity (from front of lens) Macro focus range: Wide: 8 - 60cm from front of lens Telephoto: 40 - 60cm from front of lens
Autofocus system:	Video AF
Shutter:	CCD electronic shutter and mechanical shutter Shutter-speed range: 1 - 1/1000s
Flash recycling time:	10s or less
Viewfinder type:	Optical real-image zoom viewfinder
Field of view:	80% (approx.)
Eye-relief:	15mm (from eyepiece)
A/D conversion:	10 bits
Recording media:	SD (Secure Digital) Memory Cards / MultiMediaCards
File formats:	JPEG, Motion JPEG (AVI, with audio) DCF1.0-compliant DPOF-compliant (supported by printing functions in ver.1.1)
Printing output control:	Exif 2.2, PRINT Image Matching II
LCD monitor:	3.8cm (1.5 inch) TFT color Total pixels: 62,000 (approx.) Field of view: 100% (approx.)
Menu languages:	English, German, French, Spanish
Movie recording:	File format: Motion JPEG (AVI) Number of recorded pixels: 320 x 240 60s (max.) at 15 fps with audio (monaural)

Batteries:	Two AA Ni-MH or alkaline batteries (use of Ni-MH batteries is recommended) Or one CR-V3 lithium battery
External power source:	3V DC (with specified AC adapter)
Battery performance (Recording):	Approximately 150 frames: based on Minolta's standard test method: 1850mAh Ni-MH battery, LCD monitor on, 1600x1200 Fine, flash used with 50% of the frames.
Computer interface:	USB 1.1
AV output:	NTSC, PAL (selected on the camera)
Dimensions:	106.0 (W) X 66.5 (H) X 34 (D) mm 4.2 (W) X 2.6 (H) X 1.3 (D) in. (without lens section)
Weight:	Approximately 200g / 7.1 oz. (without batteries or recording media)
Operating temperature:	0 - 40°C / 32 - 104°F

Specifications are based on the latest information available at the time of printing and are subject to change without notice.

MINOLTA

© 2003 Minolta Co., Ltd. under the Berne Convention
and the Universal Copyright Convention.

0-43325-53194-1

9222-2727-11 PM-A303/ME-0303
Printed in Germany