

---

MINOLTA

*Dimâge 2330*  
**ZOOM**

**E**

**Camera Instruction Manual**

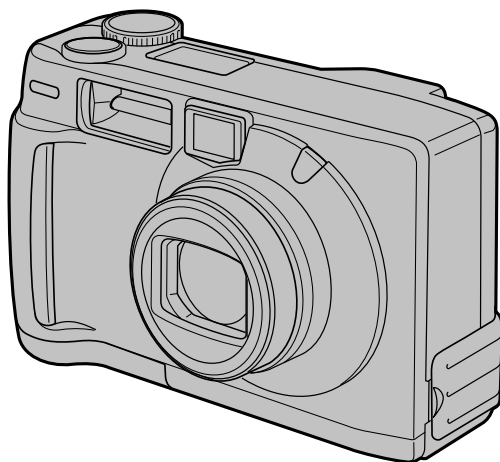



---

Thank you for purchasing the Minolta Dimâge 2330 ZOOM.  
Please take the time to read through this instruction manual so you can enjoy all its features.

This manual contains information regarding products introduced before Sep., 2000. To obtain compatibility information for products released after this date, contact a Minolta Service Facility listed on the back cover of this manual.



This mark on your camera certifies that this camera meets the requirements of the EU (European Union) concerning interference causing equipment regulations.  
CE stands for Conformité Européenne (European Conformity).

## FOR PROPER AND SAFE USE

---

Read and understand all warnings and cautions before using this product.

### **WARNING**

Batteries may become hot or explode due to improper use.

- Use only the batteries specified in this instruction manual.
- Do not install the batteries with the polarity (+/-) reversed.
- Do not subject batteries to fire or high temperatures.
- Do not attempt to recharge, short, or disassemble.
- Do not mix batteries of different types, brands, or ages.
- Follow local regulations for battery disposal.

Use caution, accidents may occur when using this product near young children.

Keep batteries or things that could be swallowed away from young children. Contact a doctor immediately if an object is swallowed.

Immediately remove the batteries and discontinue use if...

- the camera is dropped or subjected to an impact in which the interior is exposed.
- the product emits a strange smell, heat, or smoke.

Do not walk while looking at the monitor.

Do not disassemble. Electric shock may occur if a high voltage circuit inside the camera is touched.

Take your camera to a Minolta Service Facility when repairs are required.

### **CAUTION**

The heat of the camera rises with extended periods of use. Use caution when handling the camera or removing the batteries and compact flash card.

## BEFORE YOU BEGIN

---

Check the packing list before you begin. If some parts are missing, contact your camera dealer or a Minolta Service Facility listed on the back cover of this manual.

- **Minolta Dimâge 2330 ZOOM camera (x 1)**
- **AA-size Alkaline Batteries (x 4)**
- **Video Cable (x 1)**
- **Hand Strap (x 1)**
- **Camera Case (x 1)**
- **USB Cable (x 1)**
- **8MB CompactFlash Card (x 1)**
- **Software and Documentation on CD-ROM:**
  - USB Driver Software for Windows®98/Windows®98 Second Edition
  - Instruction Manual (PDF) Windows®/Macintosh
  - Adobe PhotoDeluxe 4.0 Family Edition CD-ROM for Windows®
  - Adobe PhotoDeluxe 2.0 CD-ROM for Macintosh
- **Documentation (Printed)**
  - Quick Reference Guide (x 1)
  - Warranty Card (x 1)

# TABLE OF CONTENTS

---

FOR PROPER AND SAFE USE.....	4
BEFORE YOU BEGIN.....	5
TABLE OF CONTENTS .....	6
NAMES OF PARTS.....	10
CAMERA BODY.....	10
INSIDE THE TERMINAL COVER.....	12
BOTTOM OF BODY.....	12
DATA PANEL.....	13
VIEWFINDER .....	14
QUICK REFERENCES.....	16
GETTING STARTED.....	16
TAKING PICTURES.....	16
MONITORING THE CAPTURED IMAGES.....	18
DELETING IMAGES.....	19
PREPARATION	
ATTACHING THE HAND STRAP.....	23
INSERTING THE BATTERIES.....	24
CHECKING THE BATTERY POWER .....	26
AUTO POWER OFF .....	27
USING THE AC ADAPTER (Sold Separately) .....	27
INSERTING/REMOVING THE COMPACT FLASH (CF) CARD .....	28
INSERTING THE CF CARD .....	28
REMOVING THE CF CARD .....	29
TAKING PICTURES	
BASIC RECORDING PROCEDURE .....	32
THE RECORDING MODE DISPLAY ON THE LCD MONITOR.....	34
THE DISPLAY OF THE CAMERA SETTINGS .....	35
ADJUSTING THE FOCUS.....	36
FOCUS LAMP .....	36
FOCUS DISTANCE IN THE AUTOFOCUS MODE	
(Minimum Focus Distance).....	36
THE SUBJECT THAT IS DIFFICULT TO FOCUS	
IN THE AUTOFOCUS MODE.....	37
WHEN THE SUBJECT IS NOT IN THE CENTER OF THE FRAME	
(Focus Lock Function) .....	38
ADJUSTING THE FOCUS MANUALLY	
(Manual Focus Mode).....	39

# TABLE OF CONTENTS

---

FLASH .....	41
FLASH RANGE .....	41
SELECTING THE FLASH MODE .....	42
FLASH LAMP .....	43
ADVANCED OPERATIONS	
BURST IMAGE CAPTURE .....	45
SELF-TIMER.....	48
DIGITAL ZOOM.....	51
CLOSE-UP.....	53
EXPOSURE COMPENSATION .....	55
SPECIFYING THE RECORDING MODE	
SPECIFYING THE RECORDING MODE .....	58
THE RECORDING MODE MENU DISPLAY (LCD Monitor) .....	58
THE RECORDING MODE MENU ITEMS .....	58
SPECIFYING THE IMAGE QUALITY MODE .....	60
SPECIFYING THE IMAGE SIZE MODE.....	63
SPECIFYING THE WHITE BALANCE MODE .....	65
SPECIFYING THE SHARPNESS MODE .....	68
PLAYBACK MODE	
SINGLE-FRAME PLAY .....	71
THE PLAYBACK MODE DISPLAY ON THE LCD MONITOR .....	72
THE IMAGE INFORMATION DISPLAY IN THE PLAYBACK MODE .....	73
INDEX PLAY .....	74
ZOOM PLAY .....	77
SLIDE SHOW .....	79
TO START THE SLIDE SHOW .....	79
TO STOP THE SLIDE SHOW.....	81
THE SETTING IN THE SLIDE SHOW MODE MENU .....	82
DELETING IMAGES	
DELETING AN IMAGE .....	86
DELETING ALL IMAGES.....	90

# TABLE OF CONTENTS

---

SPECIFYING THE PLAYBACK MODE	
THE PLAYBACK MODE MENU.....	94
THE PLAYBACK MODE MENU (LCD Monitor).....	94
THE PLAYBACK MODE MENU ITEMS AND EACH SETTINGS.....	94
SPECIFYING THE PRINT SETTINGS WITH THE DPOF.....	96
SPECIFYING THE IMAGE AND THE NUMBER TO BE PRINTED.....	96
SPECIFYING THE INDEX PRINT SETTINGS.....	100
TO CANCEL THE PRINT SETTINGS WITH THE DPOF.....	102
FOLDER NAME.....	104
On DCF (Design rule for Camera File system) Format.....	106
SETUP	
THE SETUP MODE MENU DISPLAY.....	108
THE SETUP MODE MENU DISPLAY ON THE LCD MONITOR.....	108
THE SETUP MODE MENU ITEMS AND EACH SETTINGS.....	108
ADJUSTING THE BRIGHTNESS OF THE LCD MONITOR.....	110
SPECIFYING THE TIME FOR THE AUTO POWER OFF FUNCTION.....	112
FORMATTING THE CF CARD.....	114
SETTING THE DATE AND TIME.....	116
SETTING THE BEEP SOUND.....	120
SWITCHING THE VIDEO SIGNAL	
FROM THE VIDEO OUTPUT TERMINAL.....	122
SWITCHING THE LANGUAGE DISPLAYED ON THE LCD MONITOR.....	124
RESETTING TO THE DEFAULT SETTINGS.....	126
CONNECTING TO THE PERSONAL COMPUTER	
CONNECTING TO THE PERSONAL COMPUTER.....	129
SYSTEM REQUIREMENT.....	130
CONNECTING TO THE PERSONAL COMPUTER.....	132
INSTALLATION OF THE DRIVER SOFTWARE.....	134
WHEN DISCONNECTING THE USB CABLE.....	140
FOR WINDOWS®98/WINDOWS®98 SECOND EDITION.....	140
FOR WINDOWS®2000 PROFESSIONAL.....	140
FOR WINDOWS®ME.....	140
FOR MACINTOSH.....	141
CAUTIONS WHEN CONNECTING TO THE PERSONAL COMPUTER.....	142
INSTALLING ADOBE PHOTODELUXE.....	144



# TABLE OF CONTENTS

---

APPENDIX	
WATCHING THE CAPTURED IMAGES ON TV .....	147
TROUBLESHOOTING .....	148
NOTES ON THE HANDLING.....	152
CARE AND STORAGE .....	156
TECHNICAL DETAILS .....	157

# NAMES OF PARTS

## CAMERA BODY

\* Do not touch.

Shutter-release button

Function dial

Data panel

Viewfinder window\*

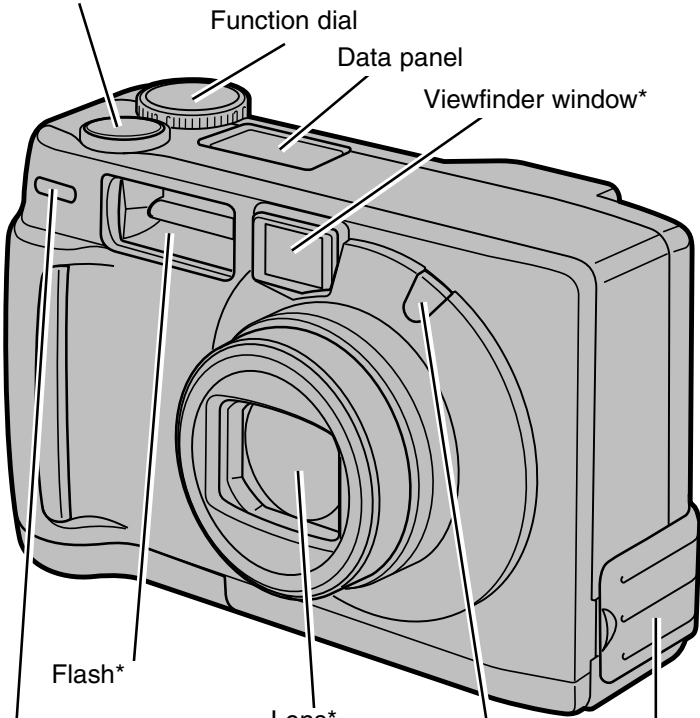

Flash\*

Lens\*

Self-timer lamp

Terminal cover

Flash sensor\*

# NAMES OF PARTS

---

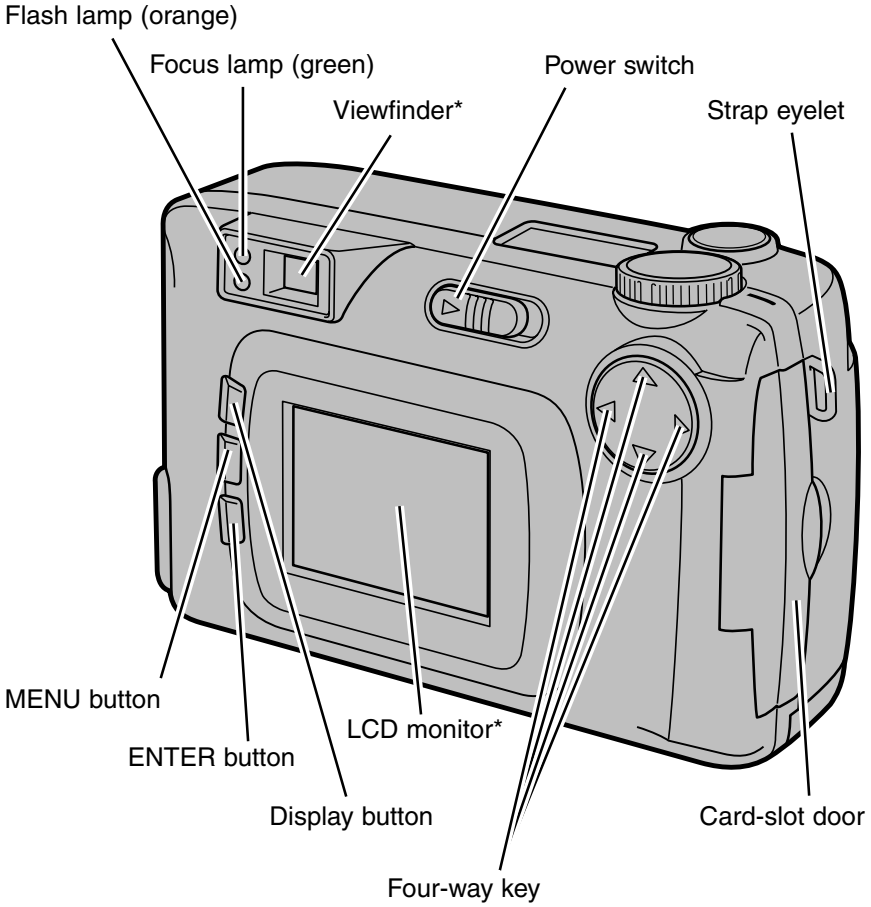

# NAMES OF PARTS

## INSIDE THE TERMINAL COVER

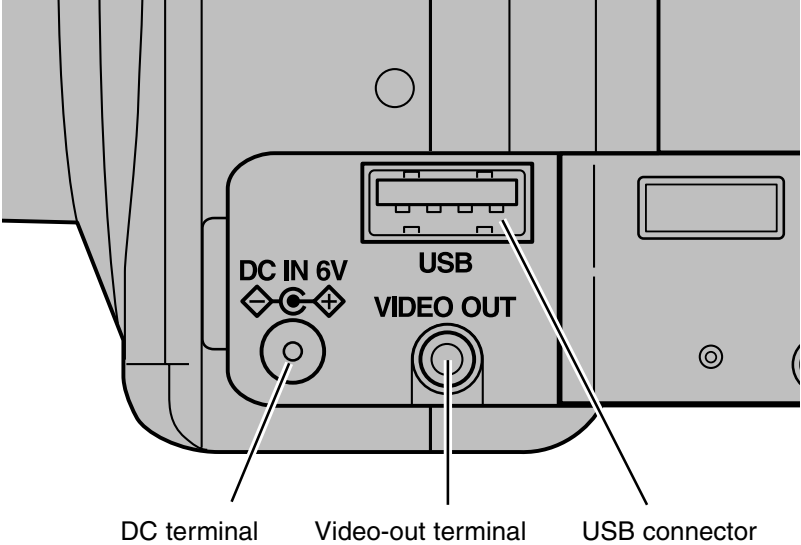

## BOTTOM OF BODY

Battery-chamber door

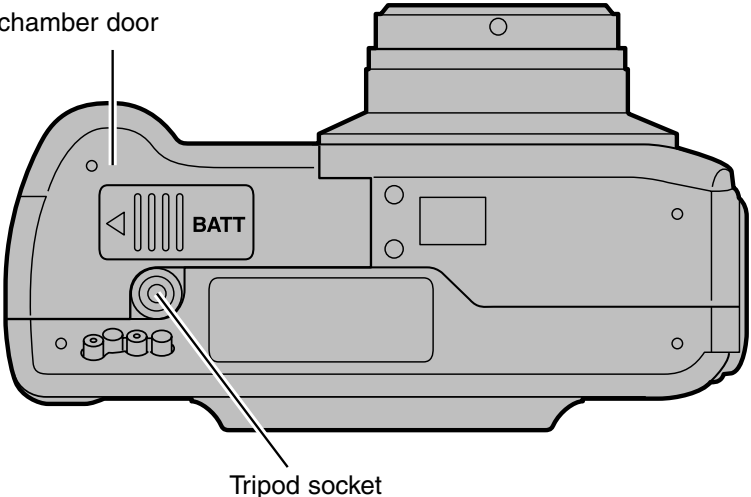

# NAMES OF PARTS

## DATA PANEL

The following diagram shows all items displayed to aid the explanation.

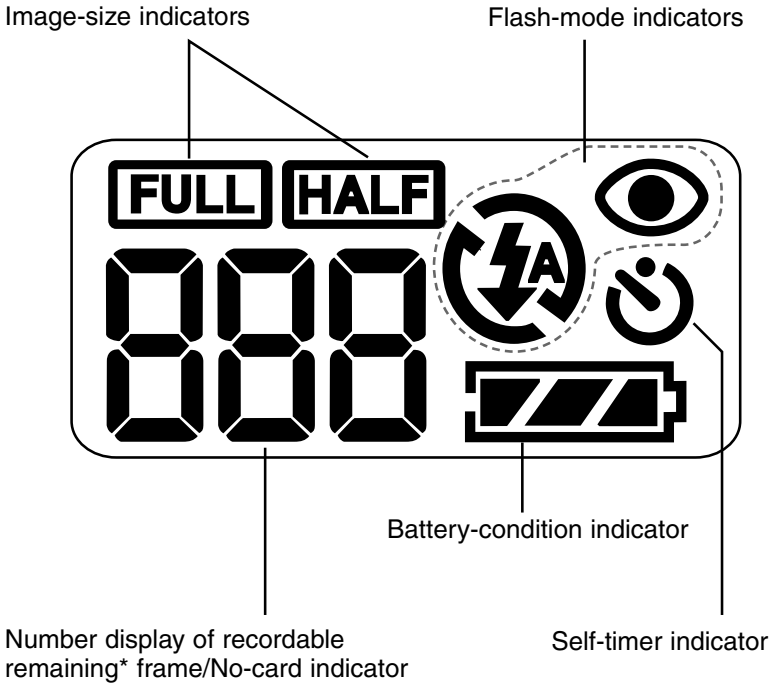

\* Refer to the number of recordable remaining frame as a guide.  
The number changes according to the scene or subject you record.

# NAMES OF PARTS

---

## VIEWFINDER

---

Focus lamp (green)

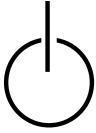

Close-framing guide

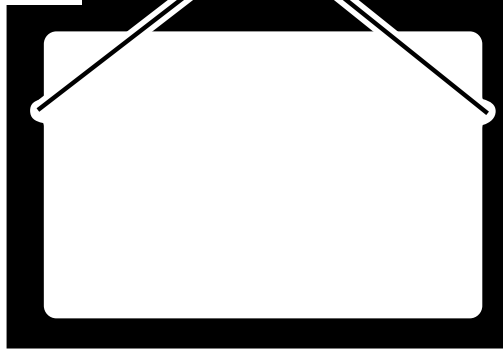

Flash lamp (orange)

### Close-framing guide

When you shoot a subject which is closer than 1m through the viewfinder, only the part under the close-framing guide is recorded. So, use the LCD monitor to check the image composition when you shoot a subject which is closer than 1m.

# NAMES OF PARTS

## Focus Lamp (Green)

Lights	The focus is determined and locked.
Blinks quickly (about 8 times in a second)	The focus is not determined. (The subject contrast is too low, the subject is too dark or too close. Or the subject is too far in the close up mode.)
Blinks slowly (about 2 times in a second).	The image is being recorded in the CF (compact flash) card. The camera is recording the image recorded in the CF card.

## Focus Area (as a Guide)

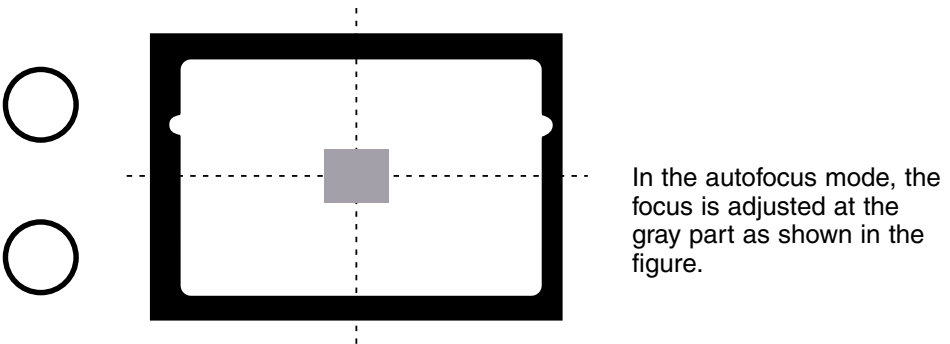

## Flash Lamp (Orange)

Lights	The flash fires.
Blinks quickly when the shutter-release button is pressed all-the-way down (about 8 times in a second).	The flash is being charged. The shutter-release button is not released.
(when the flash function is cancelled) Blinks slowly (about 2 times in a second).	The shutter speed becomes slow. Taking a picture in this mode may cause an image blurred.

# QUICK REFERENCES

---

## GETTING STARTED

---

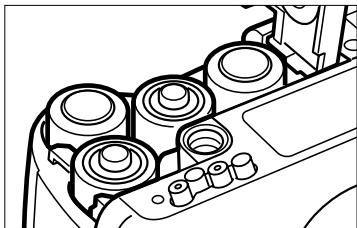

**1** Insert the batteries (see page 24).

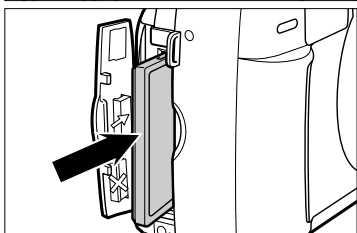

**2** Insert the CF card (see page 28).

## TAKING PICTURES

---

See page 32 for details.

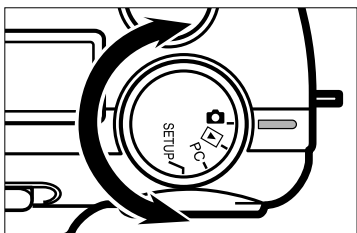

**1** Rotate the function dial to .

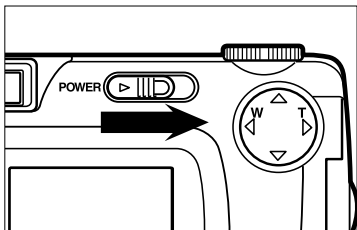

**2** Slide the power switch to turn on the camera.



## QUICK REFERENCES

---



- 3 Determine the image composition while looking into LCD monitor or viewfinder.**

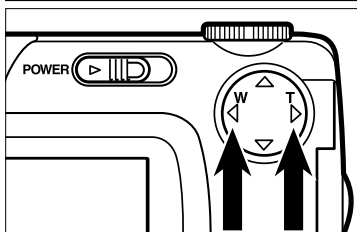

- 4 Adjust the image range and size with the four-way keys (▶/◀).**

- When the ▶ key is pressed, the image size becomes large.
- When the ◀ key is pressed, the image range becomes wide.

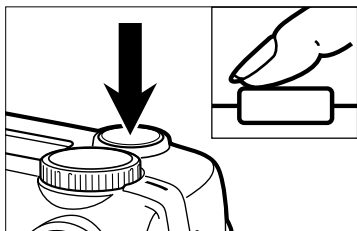

- 5 Press the shutter-release button part-way down.**

- When the image is focused, the focus lamp (green) lights up.

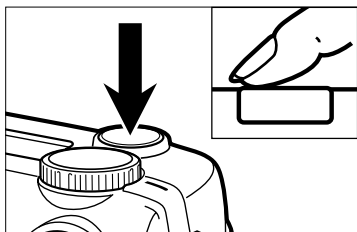

- 6 Press the shutter-release button all-the-way down to take the picture.**

- The captured image is displayed on the LCD monitor.
- While the captured image is recorded in the CF card, the focus lamp (green) blinks slowly (about 2 times in a second).

# QUICK REFERENCES

## MONITORING THE CAPTURED IMAGES

See page 71 for details.

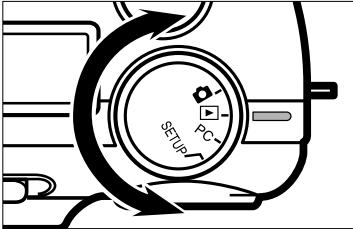

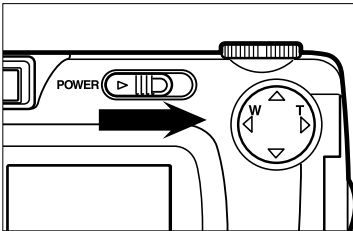

**1** Rotate the function dial to .

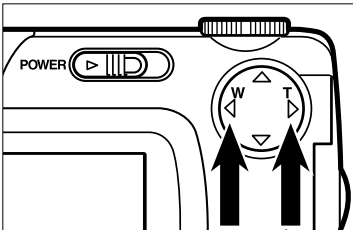

**2** Slide the power switch to turn on the camera.

- The latest image (which was recorded last) is displayed on the LCD monitor.



**3** When the  or  key is pressed, the image changes to the next or previous one respectively.

# QUICK REFERENCES

## DELETING IMAGES

See page 86 for details.

- 1 Display the image to be deleted on the LCD monitor by performing from step [1] to [3] of “MONITORING THE CAPTURED IMAGES” described on the previous page.

- 2 Press the MENU button.
  - The playback mode menu is displayed on the LCD monitor.

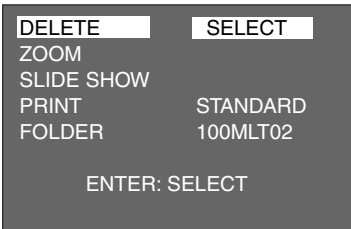
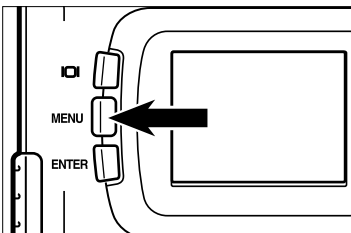

- 3 After confirming that [DELETE] is highlighted, press the ► key.

- 4 After confirming that [SELECT] is highlighted, press the ENTER button.

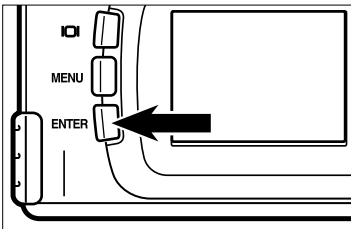

# QUICK REFERENCES

---

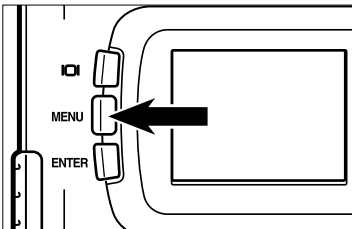
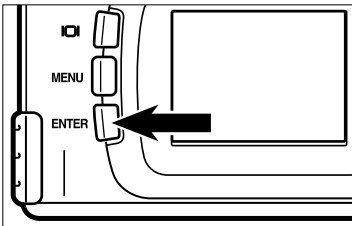
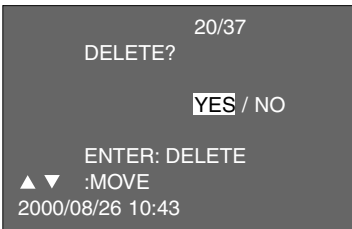
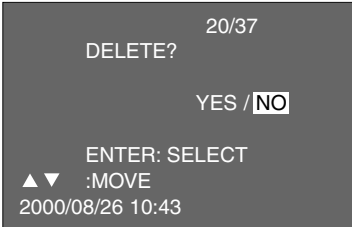

- The image to be deleted is displayed on the LCD monitor and the display to confirm whether you delete the image or not appears as shown in the figure.

**5** Press the **◀** key so that **[YES]** is highlighted and press the **ENTER** button.

- The image displayed on the LCD monitor in step [1] is deleted.

**6** To complete the operation of deleting an image, after confirming that **[NO]** is highlighted in the display to confirm, press the **ENTER** button.

- The LCD monitor display returns to the playback mode menu.

**7** Press the **MENU** button.

- The LCD monitor display returns to the normal display in the playback mode.



---

# PREPARATION

## ATTACHING THE HAND STRAP

---

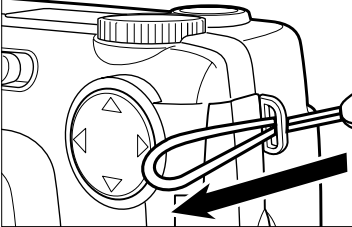

- 1** Insert the smaller loop of the hand strap through the strap eyelet.

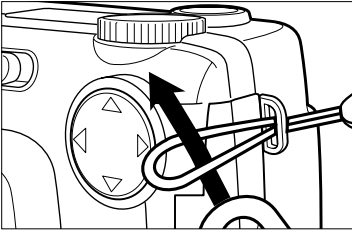

- 2** Insert the other end of the hand strap through the small loop.

# INSERTING THE BATTERIES

This camera uses four AA-size alkaline or Ni-MH batteries.

- When using AA-size Ni-MH batteries, fully recharge them with a vendor-endorsed battery charger.

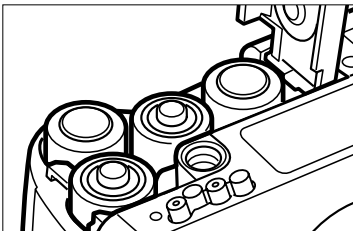
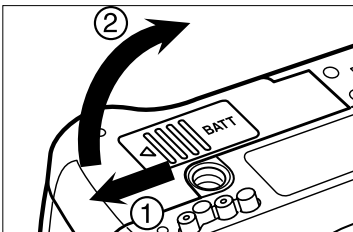
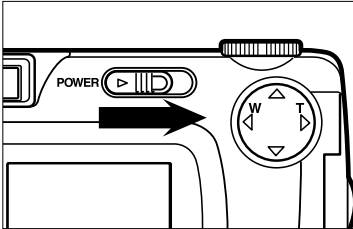

- 1** When replacing the batteries, slide the power switch to turn off the camera.
  - You may skip this step when inserting the batteries for the first time after a purchase.
- 2** Slide the battery-chamber door slightly in the (1) direction and open it in the (2) direction.
- 3** Insert the batteries by following the +/- diagram indicated on the bottom of the camera.



## INSERTING THE BATTERIES

---

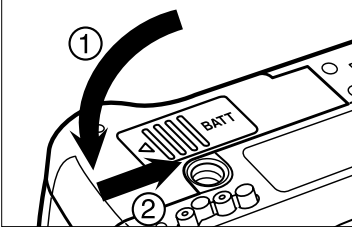

- 4 Close the battery-chamber door in the direction of the arrow (1) and slide it until it clicks (2).

\* After replacing the batteries, check that the built-in clock (date and time) works correctly (see page 116).

If neither AC adapter nor batteries are used more than 5 minutes, the built-in clock may delay or be reset to the default setting. In this case, set the date and time again by following the procedure described on page 116.

\* Do not place the camera with the battery-chamber door facing down when the battery-chamber door is open. Doing so, the battery-chamber door may be damaged.

\* As the batteries become hot right after the camera is operated, be careful when replacing the batteries.

# INSERTING THE BATTERIES

## CHECKING THE BATTERY POWER

When the batteries are installed in the camera, the camera checks the battery power automatically and shows the result on the data panel.

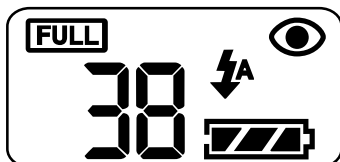

 lights — The battery power is sufficient.

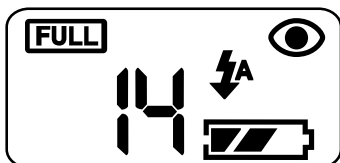

 lights — Prepare the new batteries. Even in this status, the recording or playback can be performed.

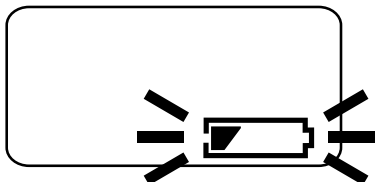

All indicators go out and after that,  blinks for 5 seconds and then, all indicators go out again.

— Perform the following either operation. Taking a picture or playing back cannot perform.

- Replace all batteries with new ones.
- Remove all batteries and use the AC adapter (sold separately) (see page 27).



- When nothing is displayed on the data panel, check that the batteries are installed with a correct polarity (+/-). When nothing is displayed even though the batteries are installed correctly, replace the batteries with new ones.

# INSERTING THE BATTERIES

## AUTO POWER OFF

To save the battery power, this camera will turned off automatically if it is not operated more than 3 minutes. (Auto Power Off function)

To operate the camera, slide the power switch to turn on the camera again.

- \* When using the batteries, the time for the auto power off function can be changed to a minute, 5 minutes, 10 minutes or 30 minutes. See page 112 for details.
- \* When using the AC adapter (sold separately), this camera will turn off automatically if it is not operated more than 30 minutes. The time for the auto power off function is fixed in 30 minutes.

## USING THE AC ADAPTER (Sold Separately)

We recommend you to use the AC adapter AC-2 (sold separately) when using the camera indoor where the AC outlet supplies the power to the camera or when connecting the camera to the computer for editing the images.

Be sure to turn off the power of the camera when changing the power supply from the batteries to the AC adapter or vice versa. Do not change it when the power of the camera is turned on.

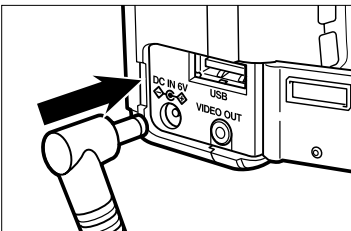

- 1 Connect the mini plug of the AC adapter to the DC terminal of the camera.**
  - The shape of the mini plug may vary depending on the AC adapter.
- 2 Connect the power plug of the AC adapter to an AC outlet.**

# INSERTING/REMOVING THE COMPACT FLASH (CF) CARD

Be sure to **turn off the power of the camera** when inserting or removing the CF card into or from the camera. Otherwise, the data in the card may be lost or the card may be damaged.

If you insert or remove the CF card when the camera is turned on, re-format the CF card after transferring the data from the card to your computer if the data is safe.

## INSERTING THE CF CARD

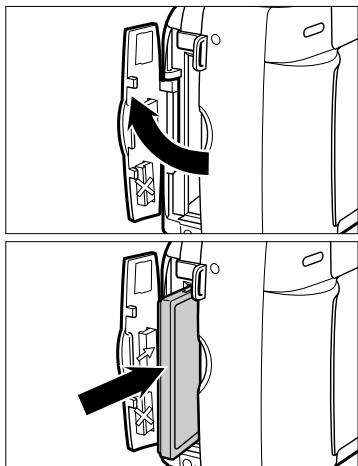

**1** Open the card-slot door as shown in the figure.

**2** Insert the CF card into the card slot.

- Position the flat edge side of the card towards the camera lens and insert the card with the signal part facing down until the card stops.
- Insert the card straight. Do not insert it on the angle.
- If the card stops halfway, check the direction of the card. Forcing the card into the slot may damage the card or the camera.

# INSERTING/REMOVING THE COMPACT FLASH (CF) CARD

---

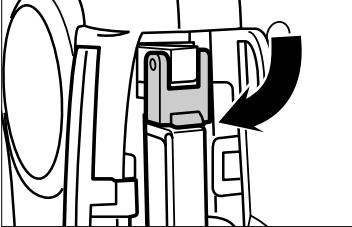

- 3** Fold the card-release lever down as shown in the figure.

- Be sure to fold the lever. Otherwise, the card-slot door cannot be closed.

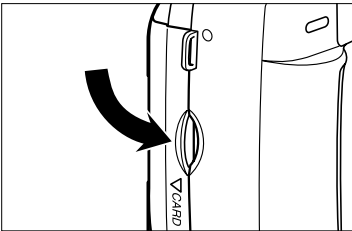

- 4** Close the card-slot door until it clicks.

## REMOVING THE CF CARD

---

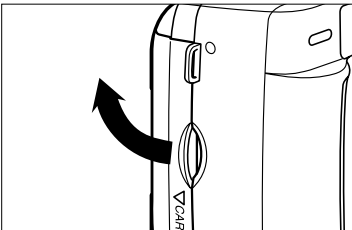

- 1** Confirm that the power of the camera is turned off.

- 2** Open the card-slot door as shown in the figure.

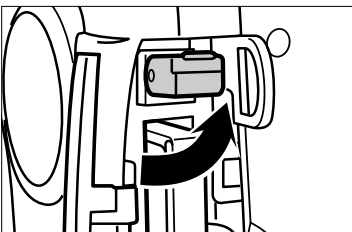

- 3** Lift the card-release lever up as shown in the figure.

## INSERTING/REMOVING THE COMPACT FLASH (CF) CARD

---

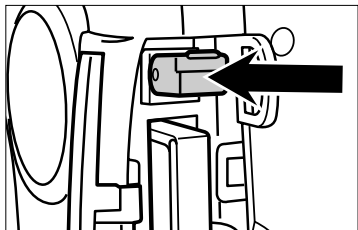

**4 Push in the card-release lever straight.**

- As the CF card ejects slightly from the camera, pull out the card.
- Be careful with the card because it may be hot.
- Keep the CF card in the protection bag supplied with the card.

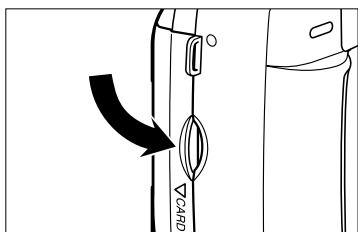

**5 Close the card-slot door until it clicks.**

---

# **TAKING PICTURES**

# BASIC RECORDING PROCEDURE

---

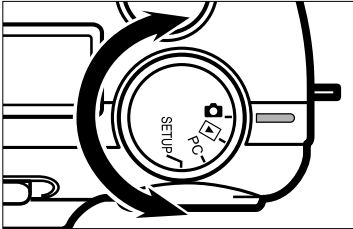

- 1 Rotate the function dial to .

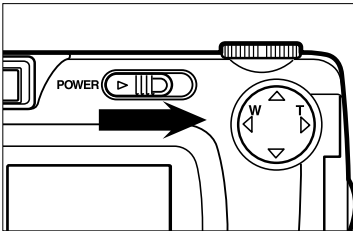





- 2 Slide the power switch to turn on the camera.
  - The power switch returns to the initial position.

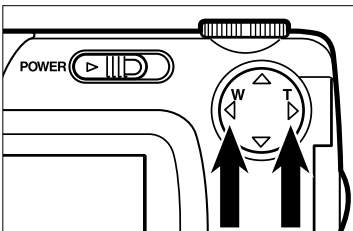

- 3 Determine the image composition while looking into either LCD monitor or viewfinder.
  - When holding the camera, be sure not to cover the lens with your fingers and so on.
  - When the focus is not adjusted on the subject, use the focus lock function (see page 38).



- 4 Adjust the image range and size with the  /  keys.
  - When the  key is pressed, the image size becomes large (Telephoto mode).
  - When the  key is pressed, the image range becomes wide (Wide-angle mode).



## BASIC RECORDING PROCEDURE

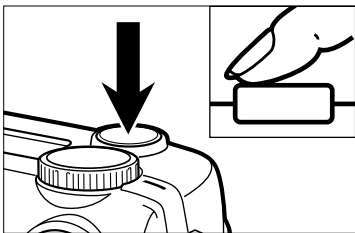

\* When pressing the shutter-release button, there is a point where the button stops halfway. To press the shutter-release button to this point is described “Press part-way down” in this manual.

### 5 Press the shutter-release button part-way down.

- The camera adjusts the focus automatically. When the subject is focused, the focus lamp (green) lights up.
- When the focus lamp (green) blinks, follow the operation from step [3] again.
- When the flash will fire, the flash lamp (orange) lights up.
- When the flash lamp (orange) blinks slowly (about 2 times in a second), the shutter speed becomes slow. Taking a picture in this mode may cause an image blurred.
- We recommend you to take pictures after fixing the camera on the tripod.

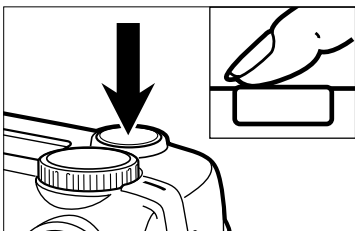

### 6 Press the shutter-release button the rest of the way down.

- If the flash lamp (orange) blinks when the shutter-release button is pressed all the way down, the flash is being charged. When the shutter-release button is kept pressed in this status, the shutter is released at the same time when the flash is charged.
- The captured image is displayed on the LCD monitor and is recorded in the CF card. While the image is recorded, the focus lamp (green) blinks slowly (about 2 times in a second) and “RECORDING” blinks on the LCD monitor slowly.

**Be sure not to open the battery-chamber door, disconnect the plug of the AC adapter or remove the CF card until the recording in the CF card is completed (until the focus lamp (green) and “RECORDING” stops blinking). The data in the CF card may be damaged or lost.**

# BASIC RECORDING PROCEDURE

## THE RECORDING MODE DISPLAY ON THE LCD MONITOR

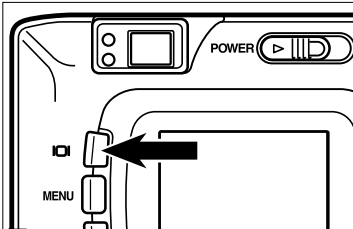

Each time the display button is pressed, the display on the LCD monitor changes in the following order.

### Live view

(The camera settings are displayed)

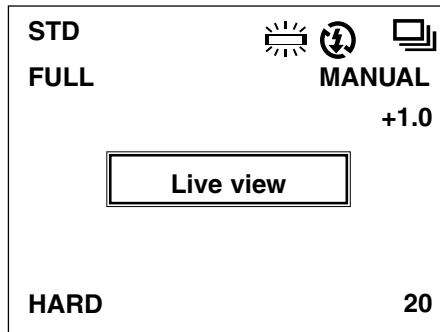

The LCD monitor is turned off

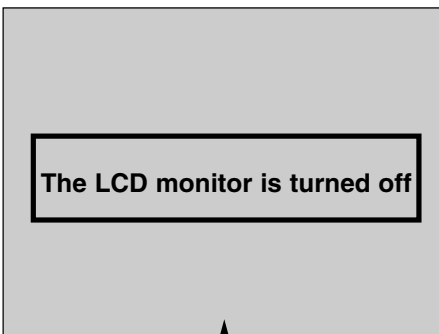

Live view

(The camera settings are not displayed)

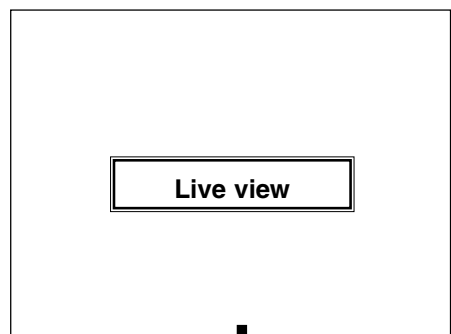

# BASIC RECORDING PROCEDURE

## THE DISPLAY OF THE CAMERA SETTINGS

(For details, see the pages in parentheses)

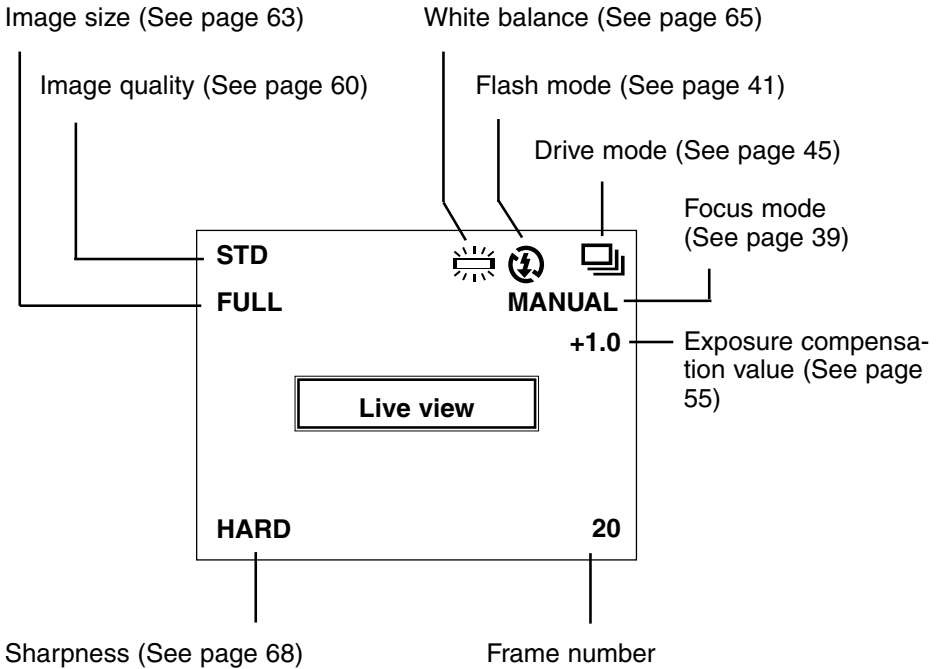

# ADJUSTING THE FOCUS

## FOCUS LAMP

When the shutter-release button is pressed halfway, this camera adjusts the focus automatically and the focus lamp (green) shows the focus status (when the focus mode is set to the autofocus mode.)

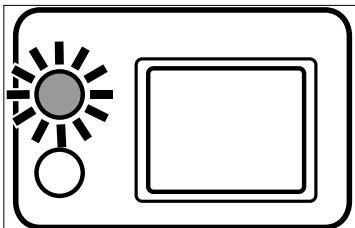

**When the focus lamp (green) blinks, check the following points:**

- Do you attempt to adjust the focus on the subject which is difficult to focus in the autofocus mode ? (See page 37.)
- Is the subject closer than the minimum focus distance (or farther than 40 cm in the close up mode) ? (Refer to the followings.)

Lights	The focus is determined and locked
Blinks quickly (about 8 times in a second)	The focus is not determined. The shutter can be released.

## FOCUS DISTANCE IN THE AUTOFOCUS MODE (Minimum Focus Distance)

The focus distance in the autofocus mode is described on the list below.  
When the subject is closer than the minimum focus distance (0.4 m) or farther than 40 cm in the close up mode, the focus lamp (green) blinks.

Standard mode	0.4 m ~ ∞ (infinity)
Close up mode (Refer to the page 53)	4 cm ~ 40 cm

# ADJUSTING THE FOCUS

## THE SUBJECT THAT IS DIFFICULT TO FOCUS IN THE AUTOFOCUS MODE

The autofocus mode uses the image contrast (the difference of light and dark parts) on the CCD (Charge Coupled Device) to focus on. Therefore, with the autofocus mode, the focus may not be adjusted correctly on the following subjects. In this case, use the focus lock function (see page 38), that you once focus on the other subject which is at the same distance as the subject you want to take the picture and change the image composition, or use the manual focus mode (adjust the focus manually, see page 39).



**The subject is too dark.**



**The subject has no contrast such as a blue sky or a white wall.**

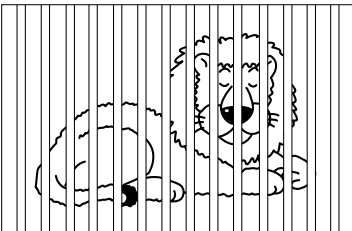

**Some subjects at different distances overlap in the focus range.**



**The subject is too bright such as a shining car body or a surface of water.**

# ADJUSTING THE FOCUS

## WHEN THE SUBJECT IS NOT IN THE CENTER OF THE FRAME (Focus Lock Function)

When the subject is not in the center of the frame, the camera adjusts the focus on the background. In this case, take a picture with the focus lock function.

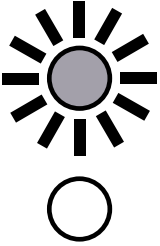

**1** Aim the camera so that the subject is in the center of the frame and press the shutter-release button part-way down.

- The camera adjusts the focus automatically. When the focus is adjusted, the focus lamp (green) lights.

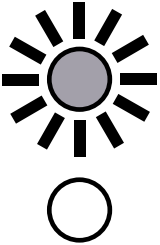



**2** While you hold pressing the shutter-release button part-way down, change the camera position to obtain the desired image composition and press the button all-the-way down to take a picture.

# ADJUSTING THE FOCUS

## ADJUSTING THE FOCUS MANUALLY (Manual Focus Mode)

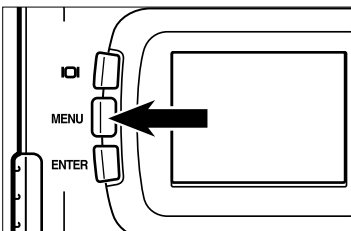
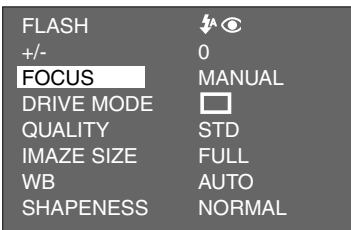
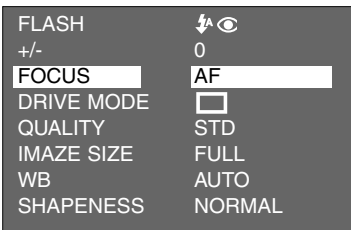
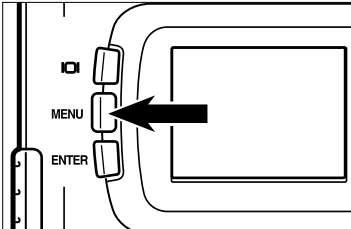
Adjust the focus with the ▲ or ▼ key while looking into the LCD monitor.



- 1 Rotate the function dial to  and press the MENU button.**
  - The recording mode menu is displayed on the LCD monitor.
- 2 Press the ▲ or ▼ key so that [FOCUS] is highlighted and press the ► key.**
- 3 Press the ▲ or ▼ key so that [MANUAL] is highlighted and press the ◀ key.**
- 4 Press the MENU button.**
  - “MANUAL” is displayed on the upper right side of the LCD monitor and the display shows that the manual focus mode is selected.

## ADJUSTING THE FOCUS

---

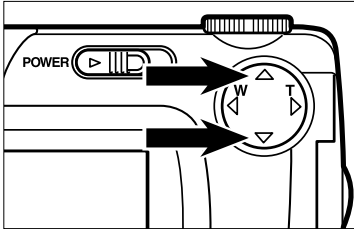

**5 Adjust the focus with the ▲ or ▼ key while looking into the LCD monitor.**

- Adjust the focus so that the subject is displayed clearly on the LCD monitor.
- When the ▲ key is pressed, the focus position is moved to the part in a long distance.
- When the ▼ key is pressed, the focus position is moved to the part in a short distance.

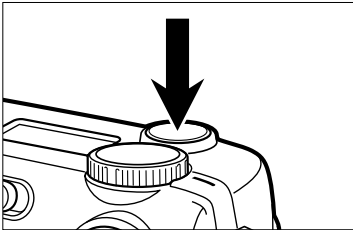





**6 Press the shutter-release button all-the-way down to take picture.**

- Even after taking a picture, the manual focus mode is not cancelled. The autofocus mode returns when the camera is turned off and on again.



# FLASH

With this camera, the following 5 flash modes are available. You can select them according to your purpose or condition.

	<p>AUTOFLASH</p>	<p>The flash fires automatically when the light level is low or the subject is backlit.</p>
	<p>FILL-FLASH</p>	<p>The flash fires every time a picture is taken regardless of the light level or backlight. Select this mode to reduce the harsh shadows when you take the picture outdoor and the subject's face is shaded with a hat and so on.</p>
	<p>FLASH CANCEL</p>	<p>The flash does not fire. Select this mode when taking a picture in the place where the flash photography is prohibited such as in a museum, etc.</p>
	<p>AUTOFLASH WITH RED-EYE REDUCTION</p>	<p>The flash fires the short burst 2 times before the main flash burst for reducing the red-eye phenomenon. Select this mode when taking the picture of people or animals in the dark.</p>
	<p>FILL-FLASH WITH RED-EYE REDUCTION</p>	

## Flash Range



The flash range has the limit. Take pictures by referring to the flash range indicated below.

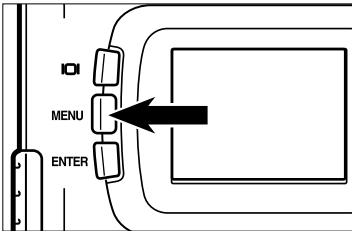

<p>The flash range</p>	<p>0.4 m ~ 3 m</p>
------------------------	--------------------

# FLASH

## SELECTING THE FLASH MODE





FLASH	
+/-	0
FOCUS	AF
DRIVE MODE	
QUALITY	STD
IMAGE SIZE	FULL
WB	AUTO
SHAPENESS	NORMAL

FLASH	
+/-	0
FOCUS	AF
DRIVE MODE	
QUALITY	STD
IMAGE SIZE	FULL
WB	AUTO
SHAPENESS	NORMAL

- 1 Rotate the function dial to  and press the MENU button.
  - The recording mode menu is displayed on the LCD monitor.

- 2 After confirming that [FLASH] is highlighted, press the  key.

- 3 Press the  or  key so that the desired flash mode is highlighted.
  - The flash mode changes in the following order.

 AUTOFLASH



 FILL-FLASH



 FLASH CANCEL



 AUTOFLASH WITH RED-EYE REDUCTION



 FILL-FLASH WITH RED-EYE REDUCTION

# FLASH

FLASH	
+/-	0
FOCUS	AF
DRIVE MODE	
QUALITY	STD
IMAGE SIZE	FULL
WB	AUTO
SHAPENESS	NORMAL

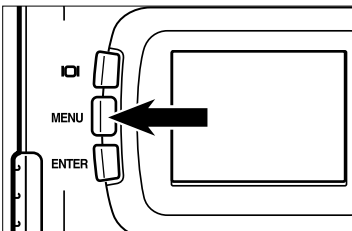

**4** Press the ◀ key.

**5** Press the MENU button.

- The selected flash mode is displayed with the icon shown on the previous page on the upper right side of the LCD monitor (see page 35). However, when “AUTOFLASH” is selected, no icon appears and when “AUTOFLASH WITH RE-EYE REDUCTION” is selected, only appears.
- The flash mode returns to “AUTOFLASH WITH RE-EYE REDUCTION” when the camera is turned off and on again.

## Flash Lamp

The flash lamp (orange) shows the flash status.

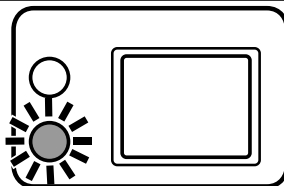

Lights	The flash fires.
Blinks quickly when the shutter-release button is pressed all the way down (about 8 times in a second).	The flash is being charged. The shutter-release button is not released.
Blinks slowly (when the flash function is cancelled). (about 2 times in a second)	The shutter speed becomes slow. Taking a picture in this mode may cause an image blurred. The flash function is cancelled when the flash mode is set to “FLASH CANCEL”, when the drive mode is set to the burst image capture or, when the focus mode is set to the close-up mode.

---

# **ADVANCED OPERATIONS**

# BURST IMAGE CAPTURE

This digital camera will continuously take pictures while the shutter-release button is held down.

The maximum number of images that can be captured at a time is follows:

Image quality	The maximum number of the pictures (as a guide)	
	FULL size	HALF size
FINE (Fine)	about 2 pictures	about 6 pictures
STD. (Standard)	about 4 pictures	about 12 pictures
ECON. (Economy)	about 8 pictures	about 12 pictures

\* See page 60 for the image quality and page 63 for the image size (FULL or HALF size).

\* The number of the picture you can take sequentially at a time described on the list above can be referred as a guide.

The number of the picture changes according to the scene or subject you record.

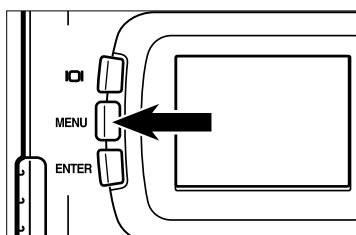

FLASH	
+/-	0
FOCUS	AF
DRIVE	
QUALITY	STD
IMAGE SIZE	FULL
WB	AUTO
SHARPNESS	NORMAL

**1** Rotate the function dial to and press the MENU button.

- The recording mode menu is displayed on the LCD monitor.

**2** Press the ▲ or ▼ key so that [DRIVE MODE] is highlighted and press the ► key.

# BURST IMAGE CAPTURE

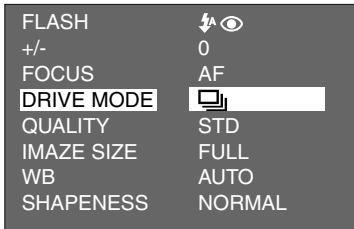

**3** Press the ▲ or ▼ key so that  is highlighted.

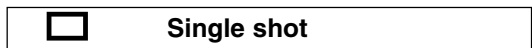

- The drive mode changes in the following order.

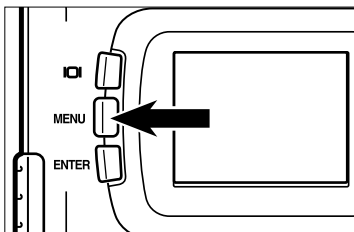
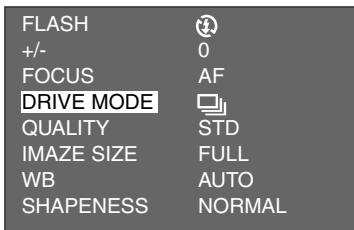

**4** Press the ◀ key.



**5** Press the MENU button.

- The sequence shot icon  appears on the upper right side of the LCD monitor. (See page 35)
- The flash mode is set to "FLASH CANCEL"  automatically. When taking a sequence shot, the flash does not fire.
- When the single shot or the self-timer shot is selected, the flash mode returns to "AUTOFLASH WITH RED-EYE REDUCTION".

# BURST IMAGE CAPTURE

---



**6 Determine the image composition while looking into LCD monitor or viewfinder and adjust the image range and size with the ► or ◀ key.**

- When the ► key is pressed, the image size becomes large (Telephoto mode).
- When the ◀ key is pressed, the image range becomes wide (Wide-angle mode).

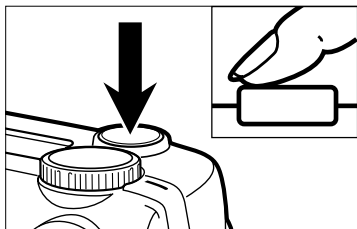

**7 Press the shutter-release button part-way down.**

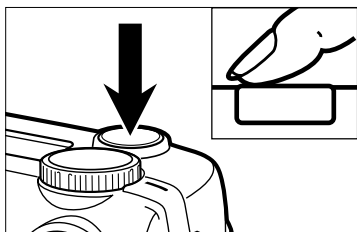

**8 Press and *hold* the shutter-release button all-the-way down.**

- When your finger is lifted from the shutter-release button or the maximum number of picture is taken, the sequence shot is completed.
- When taking burst images, the focus and exposure adjustments are determined when the shutter-release button is pressed part-way down and these adjustments are applied to all images in the sequence shot mode.
- Even after taking a sequence shot, the sequence shot mode capture is not cancelled. The single shot mode returns when the camera is turned off and on again.

# SELF-TIMER

The picture is taken about 10 seconds after the shutter-release button is pressed.

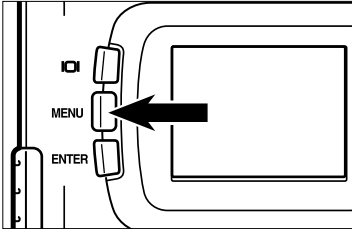

FLASH	
+/-	O
FOCUS	AF
DRIVE MODE	
QUALITY	STD
IMAGE SIZE	FULL
WB	AUTO
SHAPENESS	NORMAL

FLASH	
+/-	O
FOCUS	AF
DRIVE MODE	
QUALITY	STD
IMAGE SIZE	FULL
WB	AUTO
SHAPENESS	NORMAL

- 1** After fixing the camera on the tripod, rotate the function dial to and press the MENU button.
  - The recording mode menu is displayed on the LCD monitor.
- 2** Press the or key so that [DRIVE MODE] is highlighted and press the key.
- 3** Press the or key so that is highlighted.
  - The drive mode changes in the following order.

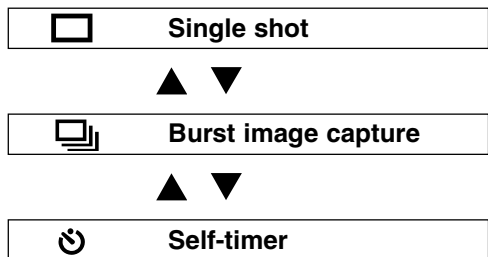



# SELF-TIMER

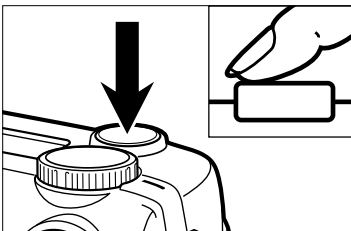
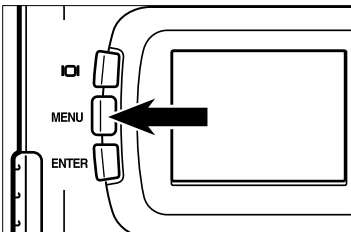
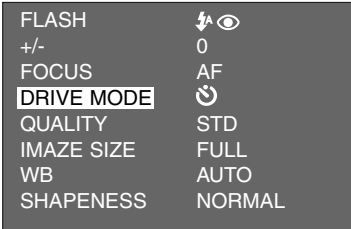

**4** Press the ◀ key.

**5** Press the MENU button.

- The self-timer shot icon 🕒 appears on the upper right side of the LCD monitor.

**6** Determine the image composition while looking into LCD monitor or viewfinder and adjust the image range and size with the ▶ or ◀ key.

- When the ▶ key is pressed, the image size becomes large (Telephoto mode).  
When the ◀ key is pressed, the image range becomes wide (Wide-angle mode).

**7** Press the shutter-release button part-way down.

## SELF-TIMER

---

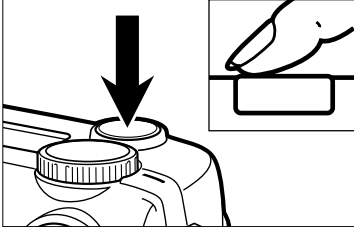

### 8 Press the shutter-release button all-the-way down to start timer.

- While the self-timer is functioning, the self-timer lamp on the front of the camera blinks. As the time to take the picture is closer, the lamp blinks faster. And just before taking the picture, the lamp lights up to show the time to take a shot.
- The beep sounds at the time when the lamp blinks. (The beep can be canceled with the menu in the SETUP mode)
- When the subject is not in the center of the frame, use the focus lock function. (See page 38)
- After taking the self-timer shot, the single-shot mode returns.

\* Do not press the shutter-release button when standing in front of the camera. The camera cannot adjust the focus.

\* To cancel the self-timer shot, rotate the function dial to , PC or SETUP.

## DIGITAL ZOOM

The digital zoom function can increase the maximum magnification (about 24 mm) of the optical zoom lens (about 114 mm converting in the 35 mm film) up to 2.5 times.

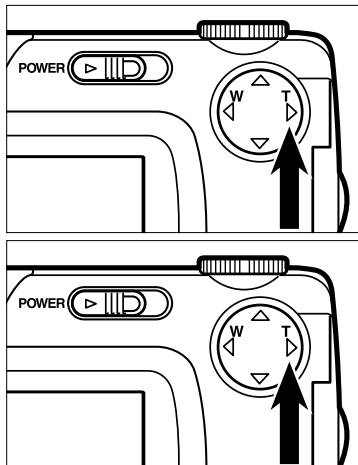

- 1 In the recording mode, press the ► key in the recording mode so that the image is zoomed to the maximum.**
- 2 Press and hold the ► key for more than 2 seconds.**
  - The digital zoom function is set.
  - The indicator that shows the image range appears on the LCD monitor as shown in the figure left below. When the indicator appears, remove your finger from the ► key.
  - The digital zoom function cannot be set when the LCD monitor is turned off.

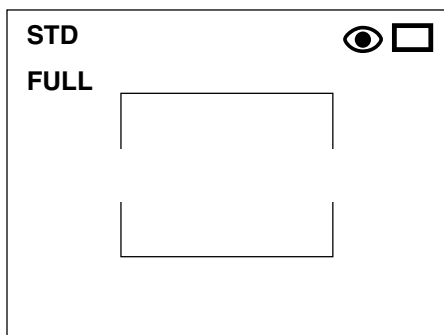

## DIGITAL ZOOM

---

- 3** While looking into the LCD monitor, determine the image composition so that the desired image is positioned within the range of the indicator.

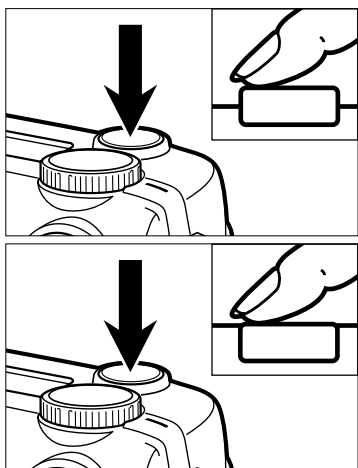

- 4** Press the shutter-release button part-way down.

- 5** Press the shutter-release button all-the-way down to take a picture.



- The focus lock function can be also used (see page 38).
- Even after taking a picture, the digital zoom is not cancelled. To cancel the digital zoom function, press and hold the ◀ key until the indicator disappears or turn off and on the camera again.

\* The image recorded with the digital zoom function is trimmed in 640 x 480 pixels. Therefore, the recorded image is smaller when displaying it on your computer or printing out it with fixing the print resolution.

# CLOSE UP

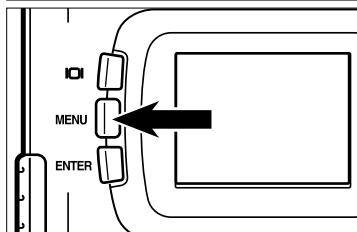
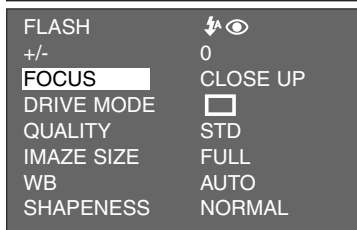
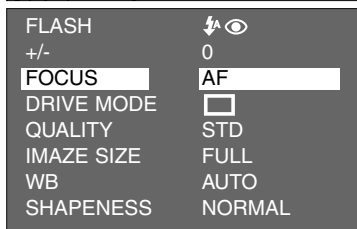
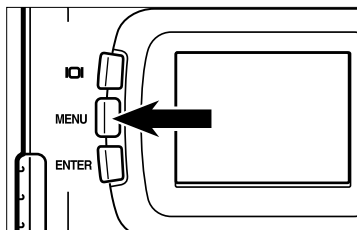
The close up function allows you to take a picture close to the subject up to 4 cm filling the frame with the subject in about 6 cm x 4 cm.



- 1 Rotate the function dial to  and press the MENU button.**
  - The recording mode menu is displayed on the LCD monitor.
- 2 Press the ▲ or ▼ key so that [FOCUS] is highlighted and press the ► key.**
- 3 Press the ▲ or ▼ key so that [CLOSE UP] is highlighted and press the ◀ key.**
- 4 Press the MENU button.**
  - “CLOSE UP” is displayed on the upper right side of the LCD monitor and it shows that the close up mode is selected.
  - The flash mode is set to “FLASH CANCEL”  automatically. When the close up mode is selected, the flash does not fire.

**5 Determine the image composition while looking into the LCD monitor.**

- There is a difference between the image range through the viewfinder and the actual one in the close up mode. We recommend you to use the LCD monitor when you determine the image composition.
- We recommend you to fix the camera on the stable stand or on the tripod.
- The LCD monitor cannot be turned off in the close up mode.

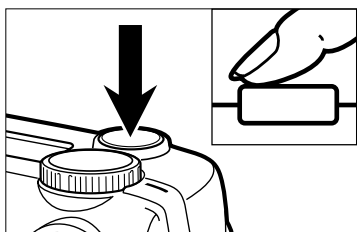

**6 Press the shutter-release button part-way down.**

- If the focus lamp (green) blinks, check that the subject is within the distance from 4 cm to 40 cm (is not apart more than 40 cm from the camera).

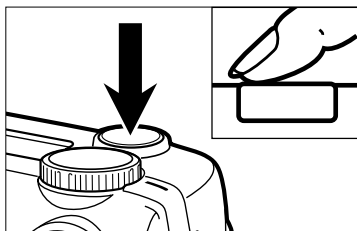

**7 Press the shutter-release button all-the-way down to take the picture.**

- Even after taking a picture, the close up mode is not cancelled. When the camera is turned off and on again, the camera enters autofocus mode.
- When the camera enters the autofocus mode, the flash mode is returned to "AUTOFLASH WITH RED-EYE REDUCTION".

# EXPOSURE COMPENSATION

This function makes the image brighter or darker by adjusting the exposure compensation value for CCD. The bigger the exposure compensation value is, the brighter the image is and the smaller the exposure compensation value is, the darker the image is.

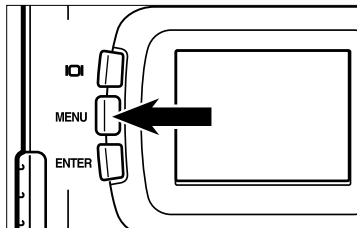

FLASH	
+/-	0
FOCUS	AF
DRIVE MODE	
QUALITY	STD
IMAGE SIZE	FULL
WB	AUTO
SHARPNESS	NORMAL

FLASH	
+/-	+1.0
FOCUS	AF
DRIVE MODE	
QUALITY	STD
IMAGE SIZE	FULL
WB	AUTO
SHARPNESS	NORMAL

- 1 Rotate the function dial to and press the MENU button.**
  - The recording mode menu is displayed on the LCD monitor.
- 2 Press the ▲ or ▼ key so that [+/-] is highlighted and press the ► key.**
- 3 Press the ▲ or ▼ key that the desired exposure compensation value appears.**
  - The exposure compensation value from +2.0 to -2.0 can be specified by 0.5 step.

# EXPOSURE COMPENSATION

FLASH	
+/-	+1.0
FOCUS	AF
DRIVE MODE	
QUALITY	STD
IMAGE SIZE	FULL
WB	AUTO
SHAPENESS	NORMAL

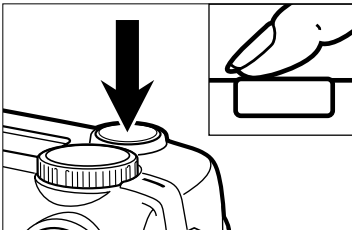
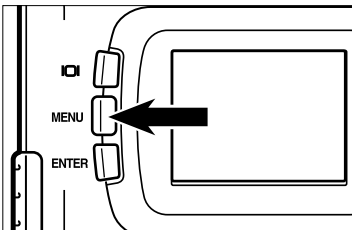

**4** Press the ◀ key.

**5** Press the MENU button.

- The exposure compensation value is specified and displayed on the upper right side of the LCD monitor (see page 35).

**6** Press the shutter-release button all-the-way down to take picture.

\* To cancel the exposure compensation function, follow the operation steps described above and specify 0 for the exposure compensation value, or turn off and on the camera again.

\* When the image to be captured is whitish, increase the exposure compensation value so that the white part can be easily represented, on the other hand, when the image to be captured is blackish, decrease the exposure compensation value so that the black part can be easily represented.



---

# **SPECIFYING THE RECORDING MODE**

# SPECIFYING THE RECORDING MODE

## THE RECORDING MODE MENU DISPLAY

(LCD Monitor)

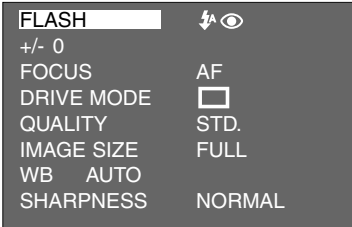

## THE RECORDING MODE MENU ITEMS

### FLASH

(For the Flash mode, see page 41)

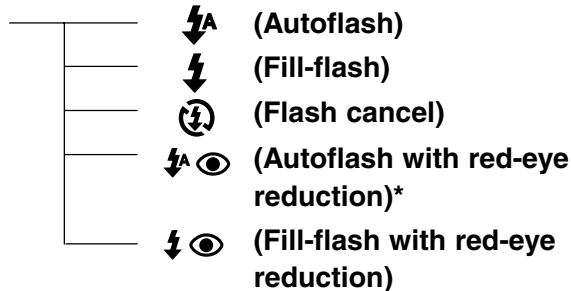

### +/-

(For the Exposure compensation, see page 55)

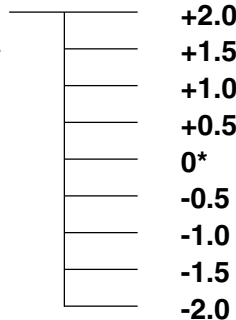

### FOCUS

(For the Focus mode, see page 36)

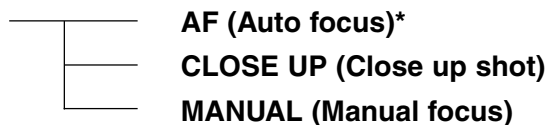

# SPECIFYING THE RECORDING MODE

## DRIVE MODE

(See page 45)

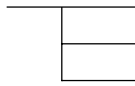

**(Single shot)\***



**(Sequence shot)**



**(Self-timer shot)**

## QUALITY

(For the Image quality, see page 60)

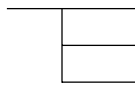

**FINE (Fine mode)**

**STD. (Standard mode)**

**ECON. (Economy mode)**

## IMAGE SIZE

(See page 63)



**FULL (Full size)**

**HALF (Half size)**

## WB

(For the White Balance, see page 65)

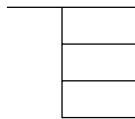

**AUTO (Auto setting)\***



**(Outdoor)**



**(Fluorescent)**



**(Tungsten)**

## SHARPNESS

(See page 68)

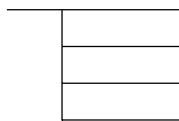

**HARD**

**NORMAL\***

**SOFT**

\* The settings indicated with \* mark are resumed when the power of the camera is turned off and on, or when the batteries are removed and inserted. For “QUALITY” and “IMAGE SIZE”, the camera memorizes the last setting before the power of the camera is turned off or before the batteries are removed.

\* For “FLASH” mode, see page 41. For the exposure compensation, see page 55. For “MANUAL Focus” mode, see page 39. For “CLOSE UP” mode, see page 53. For the “DRIVE MODE (sequence shot)”, see page 45. For the “DRIVE MODE (self-timer shot)”, see page 48.

Only the 4 items of “QUALITY” (image quality), “IMAGE SIZE”, “WB” (white balance) and “SHARPNESS” are described on the following pages.

## SPECIFYING THE IMAGE QUALITY MODE

This camera has 3 image quality modes; “FINE” (fine), “STD.” (standard) and “ECON.” (economy).

The image quality is related to the compression rate of the image. The compression rate is higher in the order of “FINE” → “STD.” → “ECON.”. The higher the compression rate is, the lower the image quality is. When you want high quality images, select “FINE”. However, as the compression rate is low, the number of the images to be recorded in the CF card is less than that in the “STD.” or “ECON.” mode. When you want to record images in the card as much as possible, select “STD.” or “ECON.”. However, as the compression rate is high, the image quality is lower than that in the “FINE” mode.

The compression rate, image recording format, image file size and the recordable number of the image using the CF card of 8 MB in each FINE, STD. and ECON. are as follows.

The compression rate	FINE (Fine) about 1/6STD.	(Standard) about 1/12	ECON.(Economy) about 1/25
The image recording format	Exif2.1-JPEG (DCF standards)		
The image file size	about 910 KB (about 270 KB)	about 560 KB (about 170 KB)	about 230 KB (about 80 KB)
The recordable number of the image using the CF card of 8 MB	about 8 (about 28)	about 13 (about 43)	about 33 (about 99)

\* Refer to the image file size and recordable number as a guide. These vary according to the scene or subject to be recorded.

The numbers in parentheses are the values when the image size is set to “HALF”.

## SPECIFYING THE IMAGE QUALITY MODE

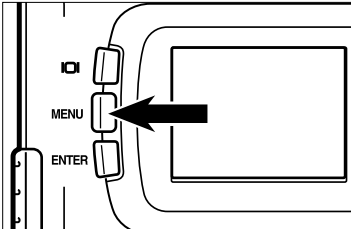

FLASH	
+/-	0
FOCUS	AF
DRIVE MODE	
QUALITY	STD.
IMAGE SIZE	FULL
WB	AUTO
SHARPNESS	NORMAL

FLASH	
+/-	0
FOCUS	AF
DRIVE MODE	
QUALITY	FINE
IMAGE SIZE	FULL
WB	AUTO
SHARPNESS	NORMAL

- 1 Rotate the function dial to and press the MENU button.**
  - The recording mode menu is displayed on the LCD monitor.
- 2 Press the ▲ or ▼ key so that [QUALITY] is highlighted and press the ► key.**
- 3 Press the ▲ or ▼ key so that the desired image quality mode is highlighted.**
  - The image quality mode changes in the following order.

FINE (Fine mode)



STD. (Standard mode)



ECON. (Economy mode)

## SPECIFYING THE IMAGE QUALITY MODE

---

FLASH	
+/-	0
FOCUS	AF
DRIVE MODE	
<b>QUALITY</b>	FINE
IMAGE SIZE	FULL
WB	AUTO
SHARPNESS	NORMAL

**4** Press the ◀ key.

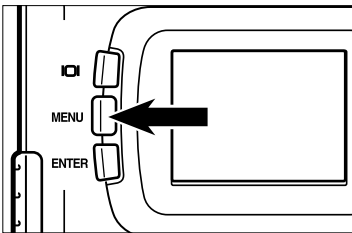

**5** Press the MENU button.

- The selected image quality mode is specified and displayed on the upper left side of the LCD monitor (see page 35).

- \* It does not matter even if there are images recorded in different image quality modes in a CF card.
- \* The setting of the image quality mode is stored in the camera's memory even after the camera is turned off.
- \* Changing the image quality mode affects the remaining number of images which can be recorded in the card. Selecting "FINE", in particular, may considerably reduce the remaining number of images. We recommend you to check the number display of recordable remaining frame on the data panel.

# SPECIFYING THE IMAGE SIZE MODE

Before taking pictures, select the image size. Changing the image size affects the number of the image which can be recorded in the CF card. The “FULL” or “HALF” size can be selected.

Image Size	Number of Pixels (W x H)
FULL	1792 x 1200
HALF	896 x 600

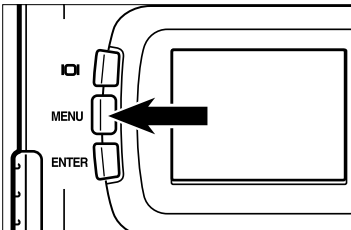

FLASH	
+/-	0
FOCUS	AF
DRIVE MODE	
QUALITY	STD.
<b>IMAGE SIZE</b>	<b>FULL</b>
WB	AUTO
SHARPNESS	NORMAL

- 1 Rotate the function dial to and press the MENU button.**
  - The recording mode menu is displayed on the LCD monitor.
- 2 Press the ▲ or ▼ key so that [IMAGE SIZE] is highlighted and press the ► key.**

# SPECIFYING THE IMAGE SIZE MODE

FLASH	
+/-	0
FOCUS	AF
DRIVE MODE	
QUALITY	FINE
<b>IMAGE SIZE</b>	<b>HALF</b>
WB	AUTO
SHARPNESS	NORMAL

FLASH	
+/-	0
FOCUS	AF
DRIVE MODE	
QUALITY	FINE
<b>IMAGE SIZE</b>	<b>HALF</b>
WB	AUTO
SHARPNESS	NORMAL

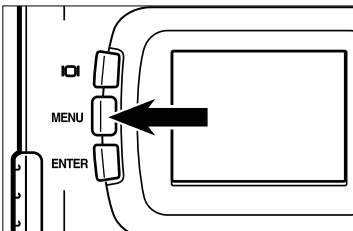

**3** Press the **▲** or **▼** key so that the desired image size mode is highlighted.

- The image size mode changes in the following order.

**FULL (Full size)**



**HALF (Half size)**

**4** Press the **◀** key.

**5** Press the **MENU** button.

- The selected image size mode is specified and displayed under the image quality on the upper left side of the LCD monitor (see page 35).



\* The setting of the image size mode is stored in the camera's memory even after the camera is turned off.

\* Changing the image size mode affects the remaining number of images which can be recorded in the card. We recommend you to check the number display of recordable remaining frame on the data panel when you change the image size mode.



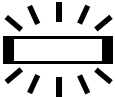

## SPECIFYING THE WHITE BALANCE MODE

This camera has four white balance modes.

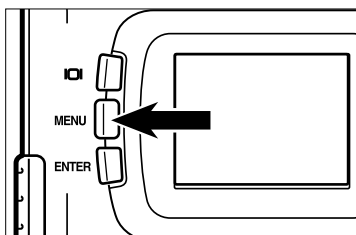
<p><b>AUTO</b></p>	<p><b>Auto white balance</b> This adjusts the white balance according to the light source incident on the CCD. Normally select this mode.</p>
	<p><b>Outdoor mode</b> Select this mode when taking the picture of the subject illuminated by a sunlight.</p>
	<p><b>Fluorescent mode</b> Select this mode when taking the picture of the subject illuminated by a fluorescent light.</p>
	<p><b>Incandescent mode</b> Select this mode when taking the picture of the subject illuminated by an incandescent light or tungsten light.</p>



- 1 **Rotate the function dial to  and press the MENU button.**
  - The recording mode menu is displayed on the LCD monitor.

FLASH	
+/-	0
FOCUS	AF
DRIVE MODE	
QUALITY	FINE
IMAGE SIZE	HALF
<b>WB</b>	<b>AUTO</b>
SHARPNESS	NORMAL

- 2 **Press the ▲ or ▼ key so that [WB] is highlighted and press the ► key.**

## SPECIFYING THE WHITE BALANCE MODE

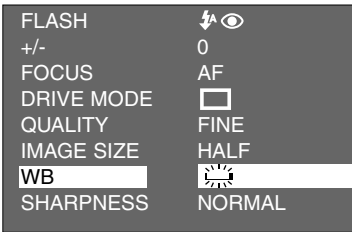

**3 Press the ▲ or ▼ key so that the desired white balance mode is highlighted.**

- The white balance mode changes in the following order.

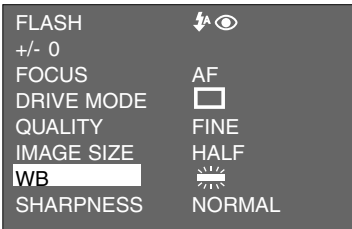
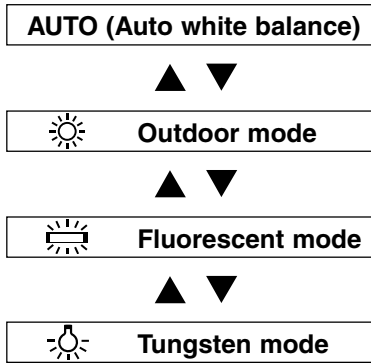

**4 Press the ◀ key.**

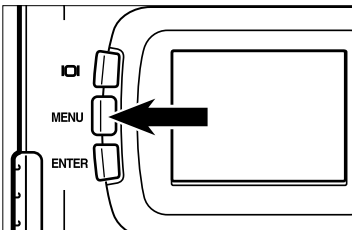

**5 Press the MENU button.**

- The selected white balance mode is specified and the icon of the selected white balance mode is displayed on the left side of the flash mode on the upper left side of the LCD monitor (see page 35). However, when "AUTO" is selected, no icon appears on the LCD monitor.

## **SPECIFYING THE WHITE BALANCE MODE**

---

\* The white balance mode returns to “AUTO” automatically when the camera is turned off and on again.

# SPECIFYING THE SHARPNESS MODE

This camera has three sharpness modes as described below.

HARD	This enhances the sharpness of image.
NORMAL	No effect of sharpness.
SOFT	This reduces the sharpness of image and makes an image soft.

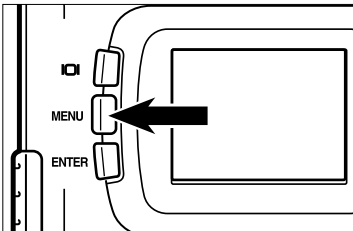

FLASH	
+/-	0
FOCUS	AF
DRIVE MODE	
QUALITY	FINE
IMAGE SIZE	HALF
WB	AUTO
SHARPNESS	NORMAL

- 1 Rotate the function dial to and press the MENU button.**
  - The recording mode menu is displayed on the LCD monitor.
  
- 2 Press the ▲ or ▼ key so that [SHARPNESS] is highlighted and press the ► key.**

# SPECIFYING THE SHARPNESS MODE

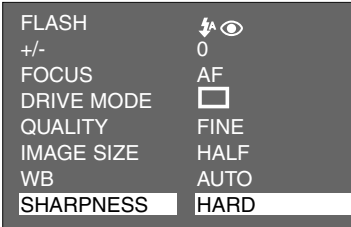

**3** Press the ▲ or ▼ key so that the desired sharpness mode is highlighted.

- The sharpness mode changes in the following order.

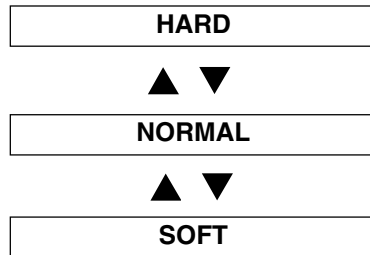

**4** Press the ► key.



**5** Press the MENU button.

- The selected sharpness mode is specified and displayed on the lower left side of the LCD monitor (see page 35). However, when "NORMAL" is selected, no display appears on the LCD monitor.

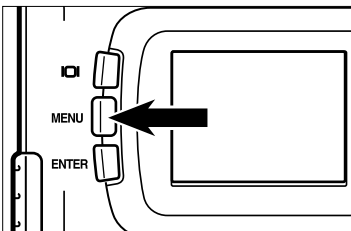

---

# PLAYBACK MODE

# SINGLE-FRAME PLAY

The images recorded in the CF card can be displayed by one frame on the LCD monitor.

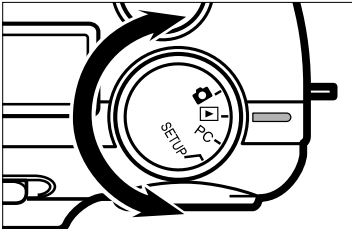

**1 Rotate the function dial to ▶.**

- The function dial can be rotated even when the camera is turned on.

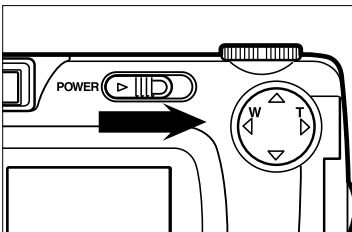

**2 When the camera is not turned on, slide the power switch to turn on the camera.**

- The power switch returns to the initial position.
- In a while, the latest image (last recorded) is displayed on the LCD monitor.

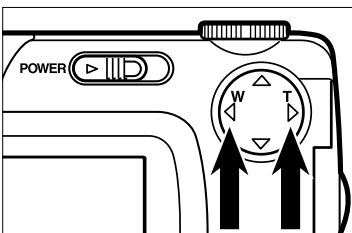

**3 Press ▶ or ◀ key to display the desired image.**

- When the ▶ key is pressed, the following image is displayed. When the ◀ key is pressed, the preceding image is displayed.
- When the latest image (last recorded) is displayed and the ▶ key is pressed, the oldest image (first recorded) is displayed.
- When the oldest image (first recorded) is displayed and the ◀ key is pressed, the latest image (last recorded) is displayed.

# THE PLAYBACK MODE DISPLAY ON THE LCD MONITOR

## THE PLAYBACK MODE DISPLAY ON THE LCD MONITOR

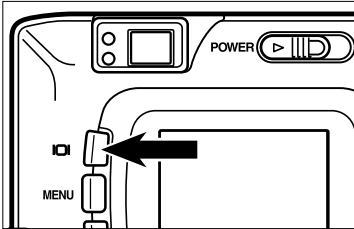

Each time the display button is pressed, the display on the LCD monitor changes in the following order.

**Single-frame play**  
(with the image information)

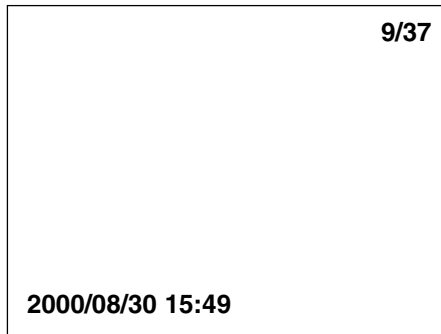

**Index play**  
(9 frames)

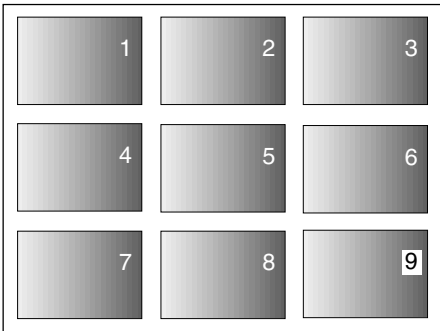

**Single-frame play**  
(with no image information)





# THE PLAYBACK MODE DISPLAY ON THE LCD MONITOR

## THE IMAGE INFORMATION DISPLAY IN THE PLAYBACK MODE

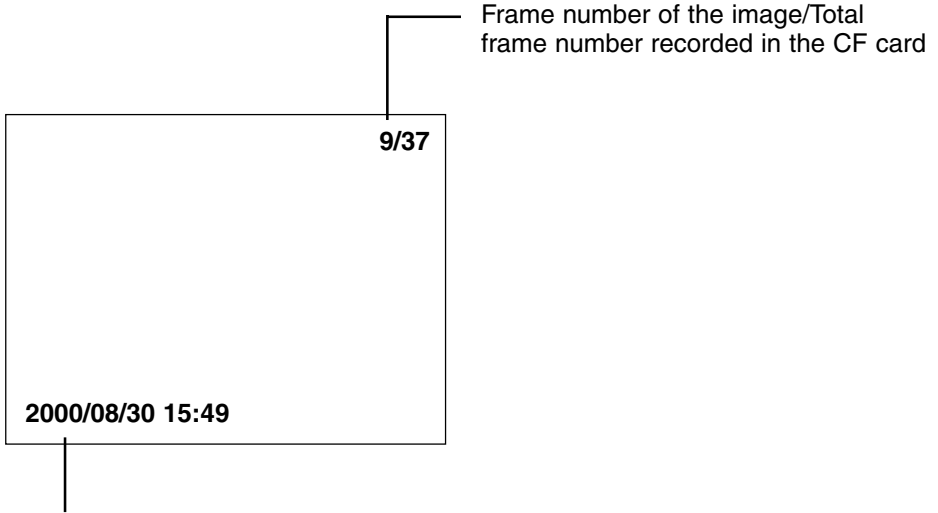

Recorded date and time of the image

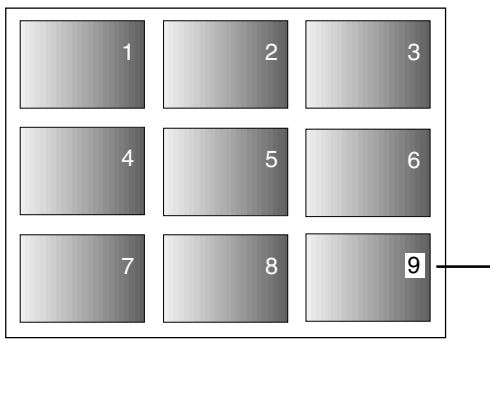

When the camera enters the index play mode, the frame number of the image displayed last in the single-frame play mode is highlighted. (The ninth frame is the last displayed image in the figure above.)

# INDEX PLAY

This mode allows you to display 9 frames at a time on the LCD monitor. It is convenient when you search the desired image quickly.

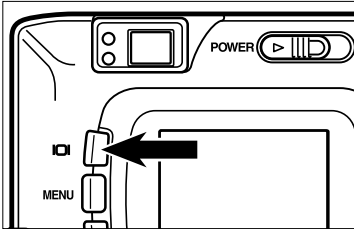

**1** When the camera is set to the single-frame play mode, press the display button once or twice (see page 72).

- When the image information is displayed in the single-frame play mode, press the display button twice and when no information is displayed, press the display button once.
- The frame number of the image displayed last in the single-frame play mode right before switching to the index play mode is highlighted. The other frame numbers are displayed white on the images.

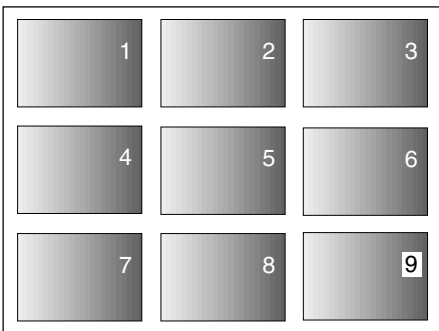
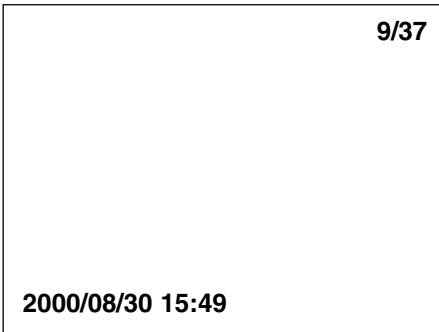

# INDEX PLAY

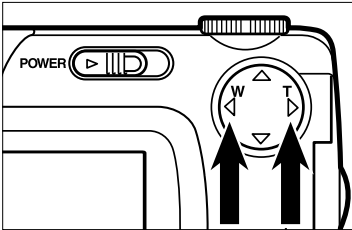

## 2 Press ► or ◀ key to select the desired image.

- When the ► key is pressed, the following image is selected and the frame number of the image is highlighted. When the ◀ key is pressed, the preceding image is selected and the frame number of the image is highlighted.
- When the ninth frame is selected (when the number 9 is highlighted) and the ► key is pressed, the following 9 frames are displayed.
- When the tenth frame is selected (when the number 10 is highlighted) and the ◀ key is pressed, the preceding 9 frames are displayed.

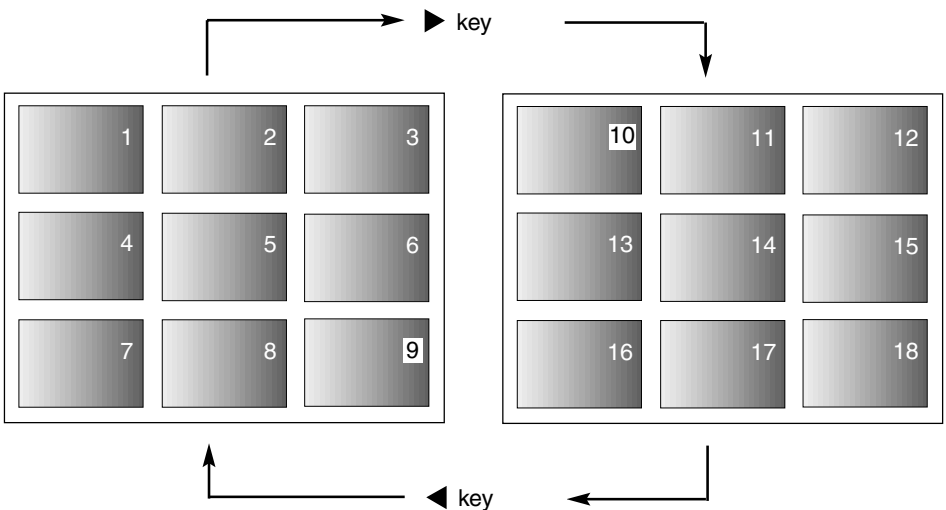

# INDEX PLAY

---

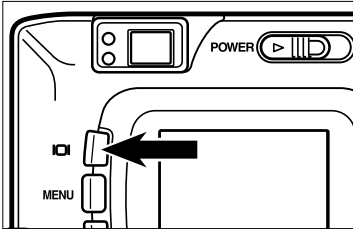

**3 Press the display button once (see page 72).**



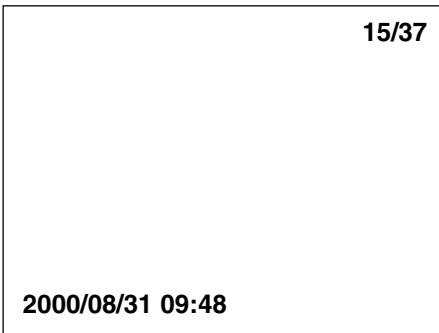
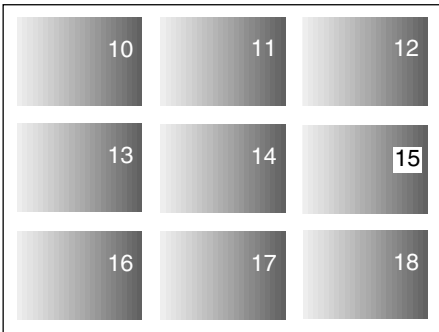



- The display on the LCD monitor switches to the single-frame play mode (with the image information) from the index play mode.
- The selected index image (whose frame number is highlighted) is displayed in the single-frame play mode.

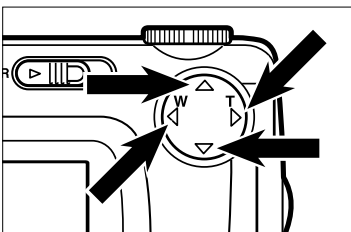
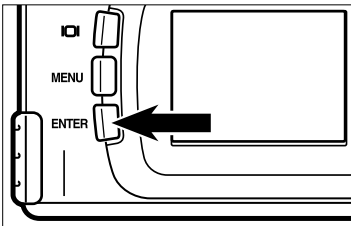
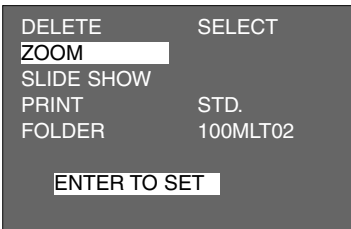
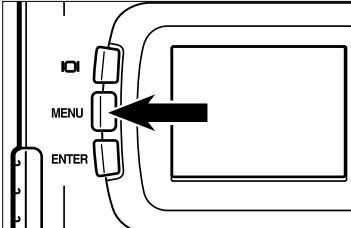

# ZOOM PLAY

This mode allows you to increase the magnification of image around the center 2.5 times and display it on the LCD monitor. It is convenient when checking the details of the image.



- 1 Rotate the function dial to  and press the MENU button.**
  - The playback mode menu is displayed on the LCD monitor.
  
- 2 Press the  or  key so that “ZOOM” is highlighted.**
  - “ENTER TO SET” is displayed on the lower side of the LCD monitor.
  
- 3 Press the ENTER button.**
  - The center part of the image selected in the single-frame play or the index play mode is magnified 2.5 times.
  
- 4 Press the , ,  or  key to scroll the magnified image.**
  - The image moves slightly in the direction of the key you press.  
The image keeps moving while the key is held and pressed.

## ZOOM PLAY

---

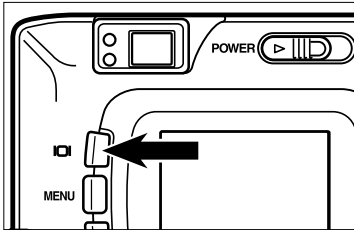

### 5 To cancel the zoom play mode, press the display button.

- When the zoom play mode is switched from the single-frame play mode, the single-frame play (with the image information) mode returns. When the zoom play mode is switched from the index play mode, the single-frame play (with no image information) mode returns when the display button is pressed, and the index play mode returns when the button is pressed again.
- The MENU button can be also used to cancel the zoom play mode. When the MENU button is pressed, the play back mode menu returns and when the button is pressed again, the signal-frame play mode returns.

\* In the zoom play mode, the image around the center is displayed in 640 x 400 pixels on the LCD monitor.



\* The image recorded with the digital zoom function (see page 51) cannot be played back in the zoom play mode. If you play such an image following steps from [1] to [3] described on the previous page, the camera returns to the single-frame play mode.

# SLIDE SHOW

## TO START THE SLIDE SHOW

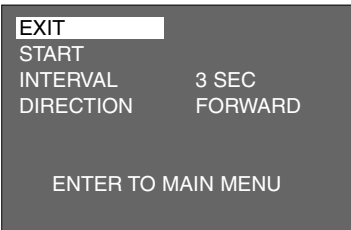
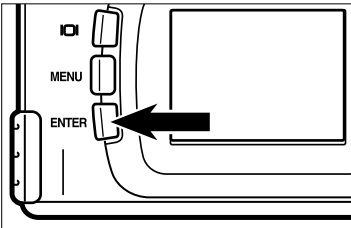
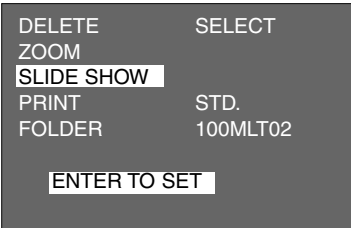
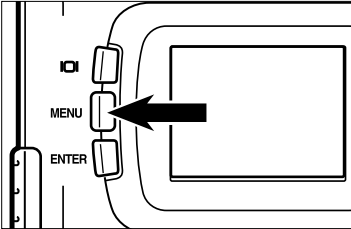
The images can be played back continuously on the LCD monitor like an automatic slide show.



- 1 Rotate the function dial to  and press the MENU button.**
  - The playback mode menu is displayed on the LCD monitor.
- 2 Press the  or  key so that [SLIDE SHOW] is highlighted.**
  - "ENTER TO SET" is displayed on the lower side of the LCD monitor.
- 3 Press the ENTER button.**
  - The slide show mode menu is displayed on the LCD monitor as shown in the figure.

# SLIDE SHOW

---

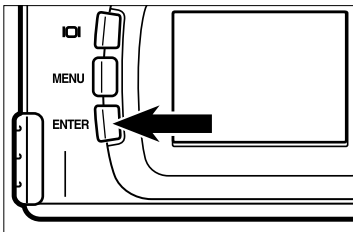
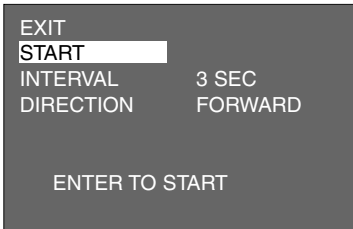

**4 Press the ▲ or ▼ key so that [START] is highlighted.**

- “ENTER TO START” is displayed on the lower side of the LCD monitor.

**5 Press the ENTER button.**

- The slide show starts according to the settings in the slide show mode menu (the settings of “INTERVAL” and “DIRECTION”).



# SLIDE SHOW

## TO STOP THE SLIDE SHOW

**1** Press one of the following buttons or keys while the slide show is performed. The slide show stops temporarily.

- Shutter-release button
- One of the ▲, ▼, ► and ◀ keys
- Display button
- MENU button
- ENTER button

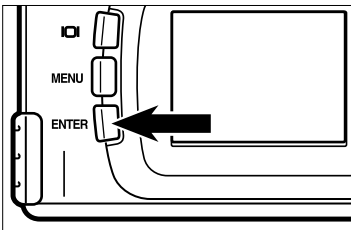

- When the ENTER button is pressed while the slide show stops temporarily, the slide show resumes playback.

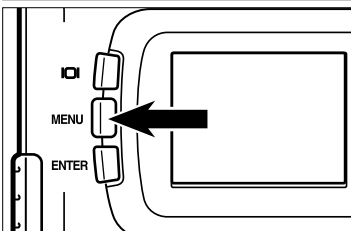

- When the MENU button is pressed while the slide show stops temporarily, the playback mode menu is displayed on the LCD monitor.

# SLIDE SHOW

## THE SETTING IN THE SLIDE SHOW MODE MENU

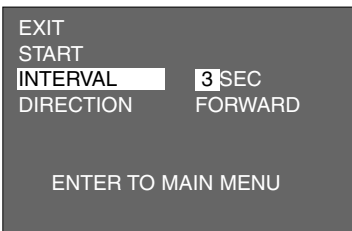
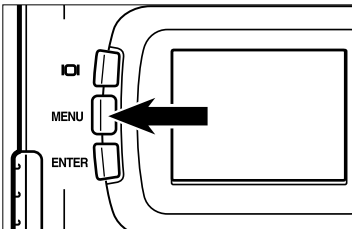
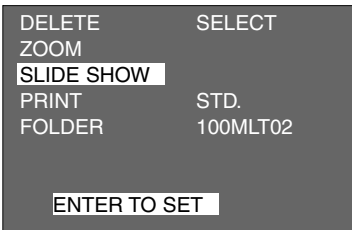
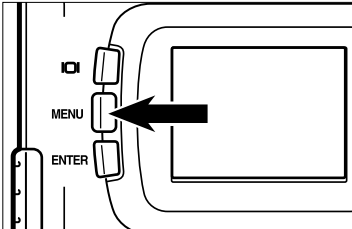



1 Rotate the function dial to  and press the MENU button.

2 Press the  or  key so that [SLIDE SHOW] is highlighted.

- "ENTER TO SET" is displayed on the lower side of the LCD monitor.

3 Press the ENTER button.

- The slide show mode menu is displayed on the LCD monitor.

4 Press the  or  key so that [INTERVAL] is highlighted and press  key.

# SLIDE SHOW

---

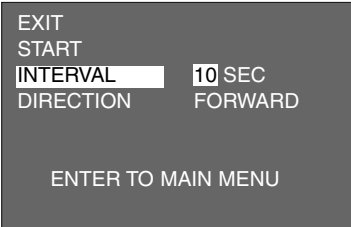

**5 Press the ▲ or ▼ key so that the desired interval time is highlighted.**

- When the ▲ key is pressed, the time increases.
- When the ▼ key is pressed, the time decreases.
- The interval time can be specified from 3 to 60 seconds by a second.
- The interval time means the time between when the image is displayed completely and when the camera starts reading the next frame.

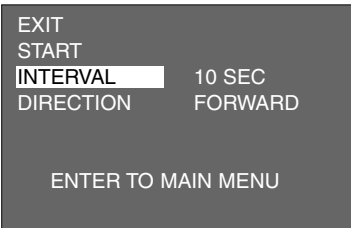

**6 Press the ◀ key.**

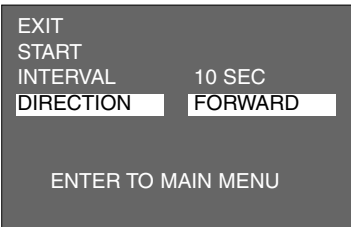

**7 Press the ▲ or ▼ key so that [DIRECTION] is highlighted and press ▶ key.**

# SLIDE SHOW

---

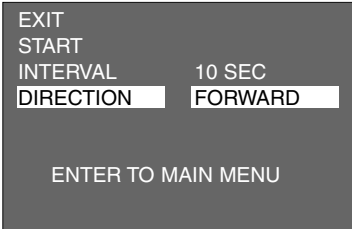

**8** Press the ▲ or ▼ key so that the desired direction is highlighted.

- The direction changes in the following order.

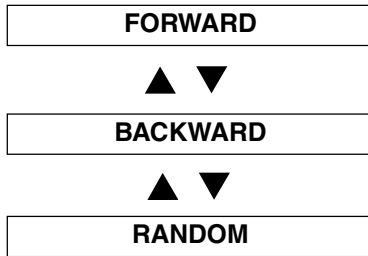

**9** Press the ◀ key.

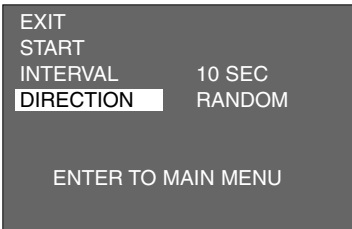

**10** Press the ENTER button.

- The playback mode menu is displayed on the LCD monitor.

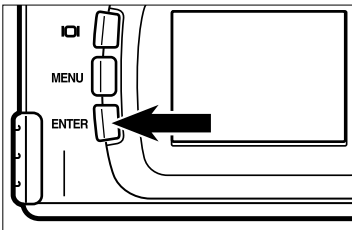

---

# DELETING IMAGES

## DELETING AN IMAGE

The images recorded in the CF card can be deleted by an image while checking them displayed on the LCD monitor.

### CAUTION

As the deleted image cannot be recovered, be careful when deleting an image.

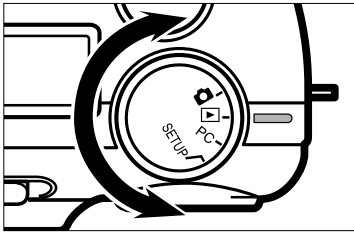

**1 Rotate the function dial to .**

- The function dial can be rotated even when the camera is turned on.

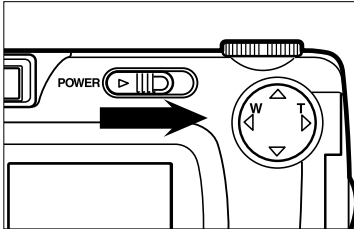

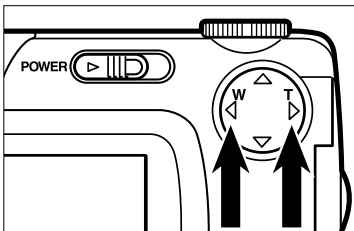

**2 When the camera is not turned on, slide the power switch to turn on the camera.**

- The power switch returns to the initial position.
- In a while, the latest image (recorded last) is displayed on the LCD monitor.



**3 Press  or  key to select the image to be deleted.**

- When the  key is pressed, the following image is selected. When the  key is pressed, the preceding image is selected.

# DELETING AN IMAGE

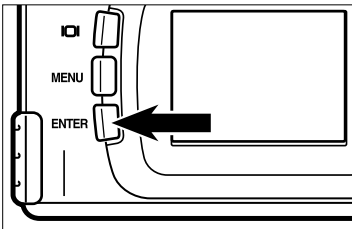
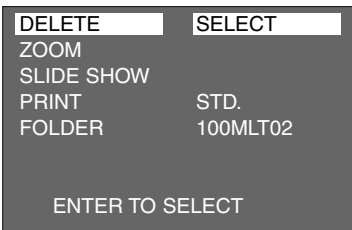
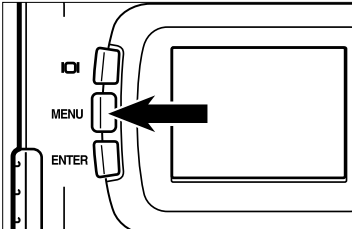

**4 Press the MENU button.**

- The playback mode menu is displayed on the LCD monitor.

**5 After confirming that [DELETE] is highlighted, press the ► key.**

**6 After confirming that [SELECT] is highlighted, press the ENTER button.**

- The image to be deleted (the image displayed on the LCD monitor in step 1) is displayed on the LCD monitor and the display to confirm whether you delete the image or not appears as shown in the figure.

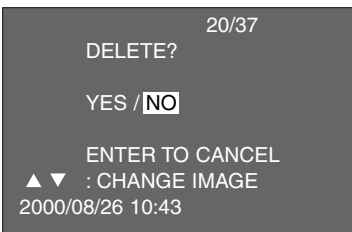

\* The colour of the background in the left figure is gray so that you can easily find out the contents of the display. However, the image to be deleted (the image displayed on the LCD monitor in step [1]) is actually displayed in the background.

## DELETING AN IMAGE

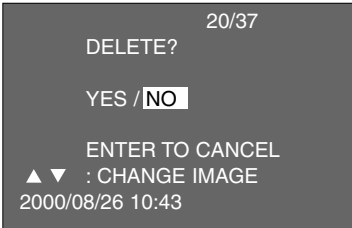
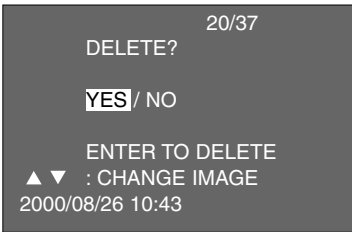

**7** Press the ◀ key so that [YES] is highlighted and press the ENTER button.

- The image displayed on the LCD monitor in step [1] is deleted.
- After deleting an image, the frame number of the image next to the deleted one is displayed ("PLAY BACK" blinks until the frame number is displayed) and the display to confirm whether you delete the image or not appears succeedingly as shown in the figure.
- On this display, the image to be deleted can be selected with the ▲ or ▼ key. When the ▲ key is pressed, the preceding image is displayed. When the ▼ key is pressed, the following image is displayed.

**8** Repeat step [7] if you have other images to be deleted.

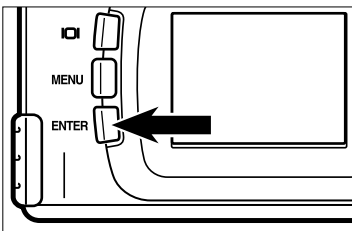

**9** To complete the operation of deleting an image, after confirming that [NO] is highlighted in the display to confirm, press the ENTER button.

- The LCD monitor display returns to the playback mode menu.



# DELETING AN IMAGE

---

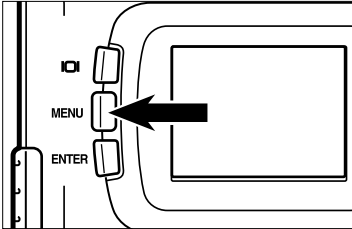

**10 Press the MENU button.**

- The LCD monitor display returns to the playback mode.

# DELETING ALL IMAGES

All images recorded in the CF card can be deleted.

## CAUTION

As the deleted image cannot be recovered, be careful when deleting all images.

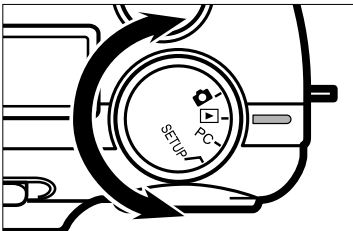

**1 Rotate the function dial to .**

- The function dial can be rotated even when the camera is turned on.

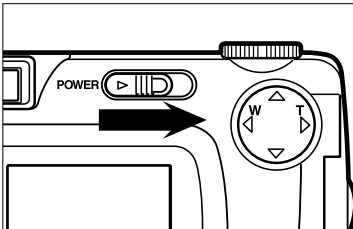

**2 When the camera is not turned on, slide the power switch to turn on the camera.**

- The power switch returns to the initial position.
- In a while, the latest image (recorded last) is displayed on the LCD monitor.

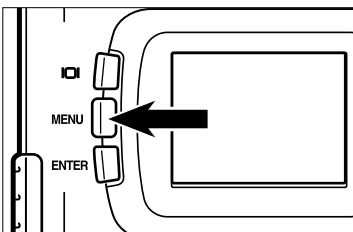

**3 Press the MENU button.**

- The playback mode menu is displayed on the LCD monitor.

## DELETING ALL IMAGES

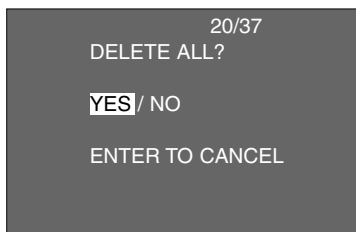
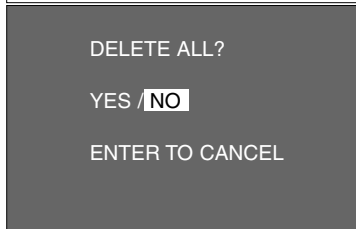
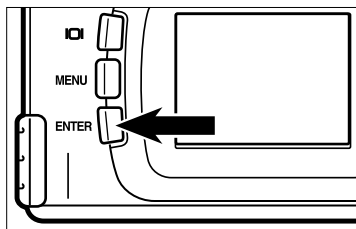
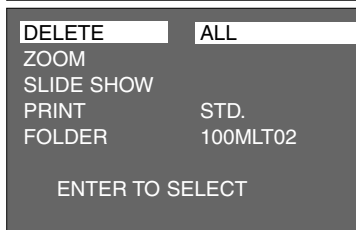
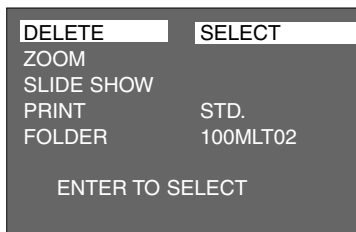

4 After confirming that [DELETE] is highlighted, press the ► key.

5 Press the ▼ key so that [ALL] is highlighted and press the ENTER button.

- The display to confirm whether you delete all images or not appears as shown in the figure.
- Only the images captured with this camera can be all deleted. Even if you insert the CF card in which the images captured with other camera is recorded, the images cannot be deleted.

6 Press the ◀ key so that [YES] is highlighted.

# DELETING ALL IMAGES

---

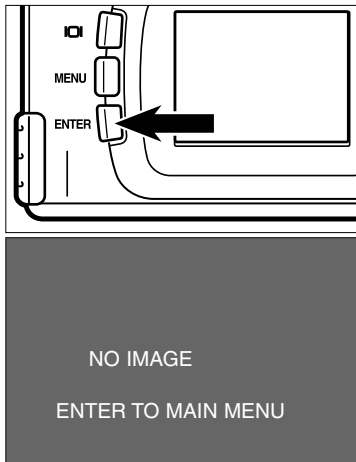

## 7 Press the ENTER button.

- All images recorded in the CF card are deleted.
- While all images are deleted, the focus lamp (green) blinks slowly (about two times a second).
- After deleting all images in the CF card, [NO IMAGE] and [ENTER TO MAIN MENU] are displayed on the LCD monitor.

---

# **SPECIFYING THE PLAYBACK MODE**

# THE PLAYBACK MODE MENU

## THE PLAYBACK MODE MENU (LCD Monitor)

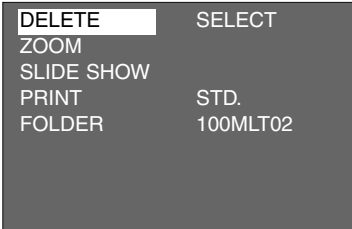

## THE PLAYBACK MODE MENU ITEMS AND EACH SETTING

### DELETE

(For deleting images, see page 86)

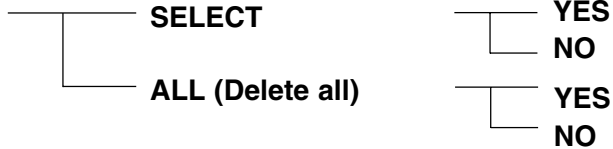

### ZOOM

(For the zoom play mode, see page 77)

### SLIDE SHOW

(For the slide show mode, see page 79)

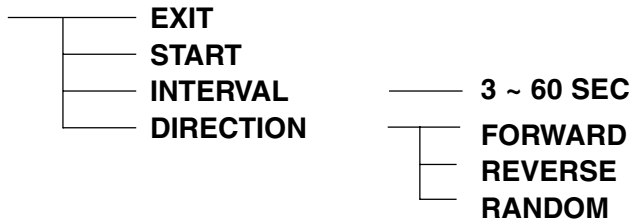

# THE PLAYBACK MODE MENU

---

## PRINT

(For specifying the print settings with the DPOF, see page 96)



## FOLDER

(Folder name, see page 104)

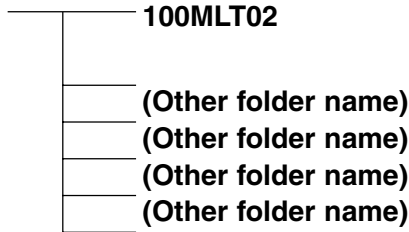

\* For “DELETE” (deleting images), see page 86. For “ZOOM” (zoom play), see page 77. For “SLIDE SHOW” (auto play), see page 79.

Only the 2 items of “PRINT” (Specifying the print setting with DPOF), “FOLDER” (Folder name) are described on the following pages.

## SPECIFYING THE PRINT SETTINGS WITH THE DPOF

---

This camera supports the DPOF™ (Digital Print Order Format) Version 1.00 so that you can specify the images and the number of copies to be printed and the print type. So, the specified images can be printed at the specified number only by handing the CF card or the SmartMedia™, etc. in which not only the captured images but the DPOF data are recorded, to the photofinishing print services supporting the DPOF. You do not need to give them the file name or your password. Also, if you set the media including the DPOF data in the personal printer which supports the DPOF, you can print the specified images at the specified number automatically.

\* The DPOF is jointly developed by Eastman Kodak Company, Canon Inc., Fuji Photo Film Co., Ltd., and Matsushita Electric Industrial Co., Ltd. for direct printing from digital camera.

\* This camera does not support “DPOF Version 1.10” which is released in July, 2000.

## SPECIFYING THE IMAGE AND THE NUMBER TO BE PRINTED

---

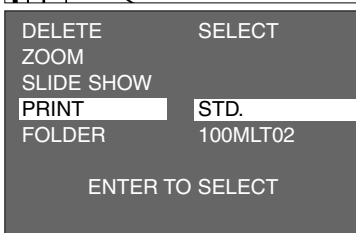
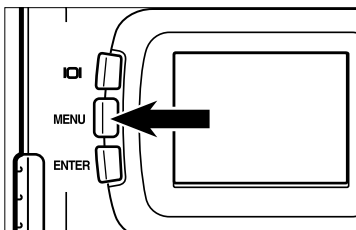

**1** Rotate the function dial to  and press the MENU button.

- The playback mode menu is displayed on the LCD monitor.

**2** Press the  or  key so that [PRINT] is highlighted and press  key.



# SPECIFYING THE PRINT SETTINGS WITH THE DPOF

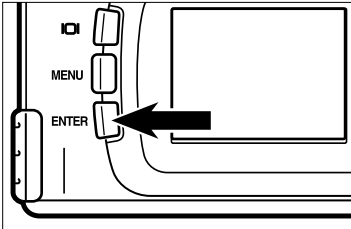

**3** After confirming that [STD.] is highlighted, press the ENTER button.

- The display to specify the number to be printed appears on the LCD monitor.

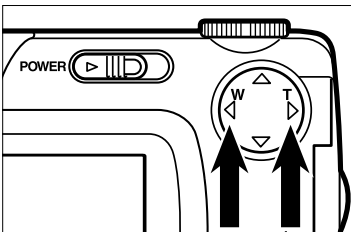
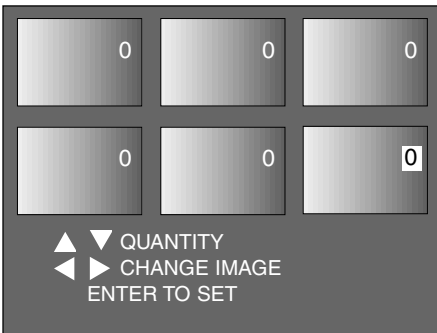

**4** Press ◀ or ▶ key to select the image to be printed.

- When the image to be printed is selected, the number to be printed is highlighted.
- When the sixth frame is selected (when the number to be printed is highlighted) and the ▶ key is pressed, the following 6 frames are displayed.
- When the seventh frame is selected (when the number to be printed is highlighted) and the ◀ key is pressed, the preceding 6 frames are displayed.

# SPECIFYING THE PRINT SETTINGS WITH THE DPOF

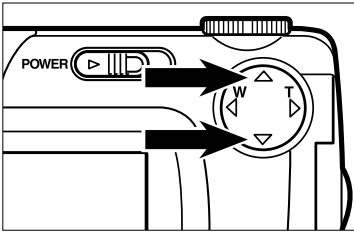

**5** Press the ▲ or ▼ key to select the number to be printed.

- When the ▲ key is pressed, the number becomes large.
- When the ▼ key is pressed, the number becomes small.

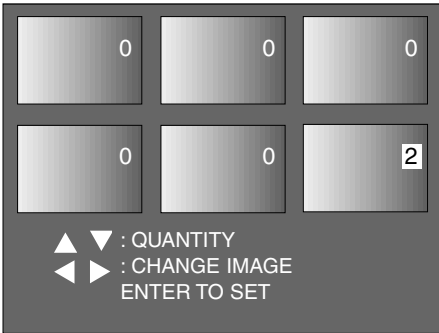

**6** Repeat step [4] and [5] to specify the number to be printed for all images.

- For the image you do not want to print, specify 0.

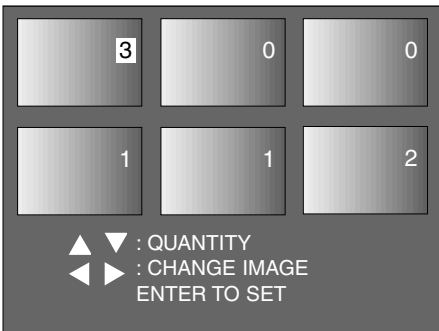

# SPECIFYING THE PRINT SETTINGS WITH THE DPOF

---

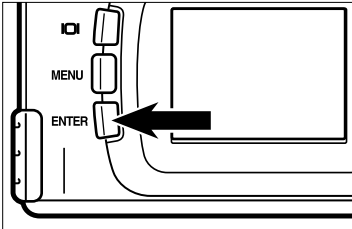

**7 Press the ENTER button.**

- The DPOF file including data of the image and the number to be printed is recorded in the CF card.
- After the file is recorded, the LCD monitor display returns to the playback mode menu.

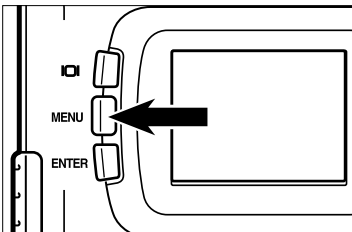

**8 Press the MENU button.**

- The LCD monitor display returns to the playback mode.





# SPECIFYING THE PRINT SETTINGS WITH THE DPOF

## SPECIFYING THE INDEX PRINT SETTING

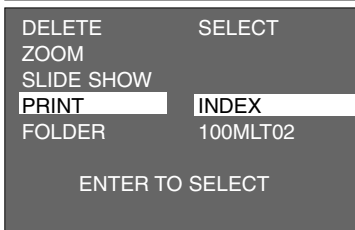
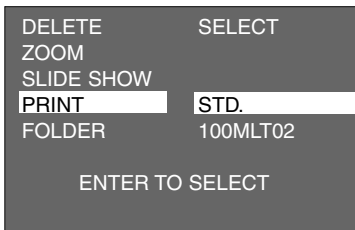
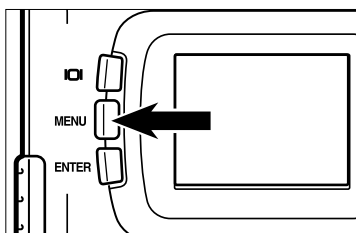
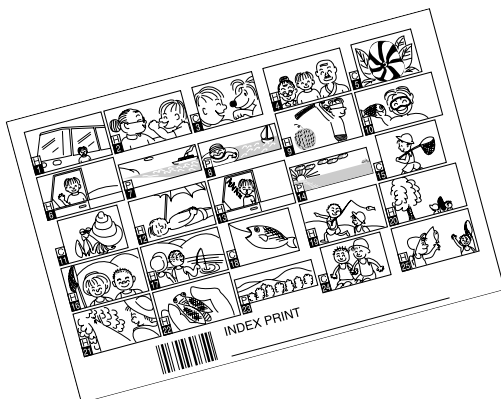
This setting allows you to print all images recorded in the CF card on one sheet as an index print.

The illustration of index print as an image.



- 1 Rotate the function dial to  and press the MENU button.**
  - The playback mode menu is displayed on the LCD monitor.
- 2 Press the  or  key so that [PRINT] is highlighted and press  key.**
- 3 Press the  key so that [INDEX] is highlighted and press the ENTER button.**
  - The display to confirm whether you print the images as an index print or not appears as shown in the figure.

# SPECIFYING THE PRINT SETTINGS WITH THE DPOF

---

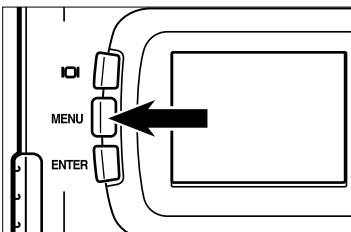
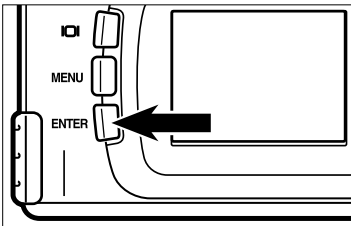
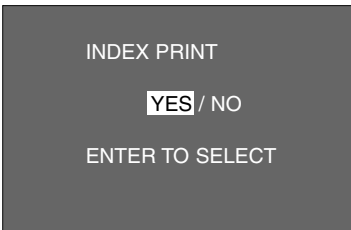

**4** Press the ▲ or ▼ key so that [PRINT] is highlighted and press ► key.

**5** Press the ENTER button.

- The DPOF file including data of the index print setting is recorded in the CF card.
- After the file is recorded, the LCD monitor display returns to the playback mode menu.

**6** Press the MENU button.





- The LCD monitor display returns to the playback mode.

# SPECIFYING THE PRINT SETTINGS WITH THE DPOF

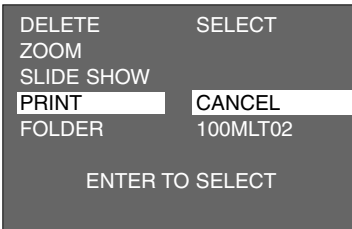
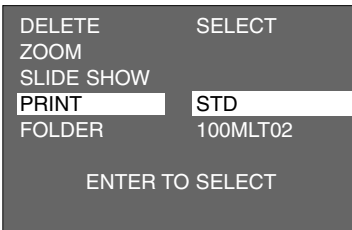
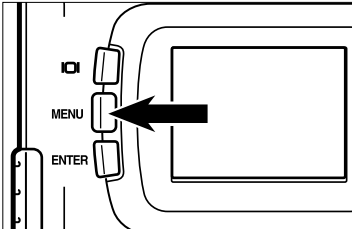
## TO CANCEL THE PRINT SETTINGS WITH THE DPOF

All print settings with the DPOF described on pages 96 to 99 can be cancelled. The index print setting (see page 100) is also cancelled.



- 1 Rotate the function dial to  and press the MENU button.**
  - The playback mode menu is displayed on the LCD monitor.
- 2 Press the  or  key so that [PRINT] is highlighted and press  key.**
- 3 Press the  key twice so that [CANCEL] is highlighted and press the ENTER button.**
  - The display to confirm whether you cancel all print settings or not appears as shown in the figure.<

# SPECIFYING THE PRINT SETTINGS WITH THE DPOF

---

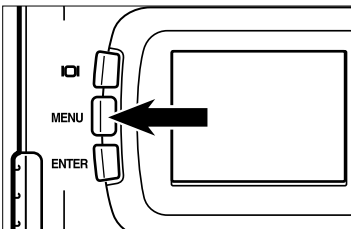
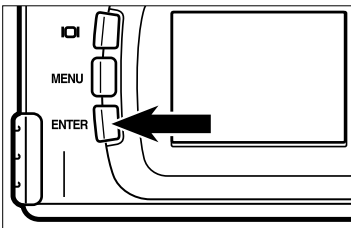
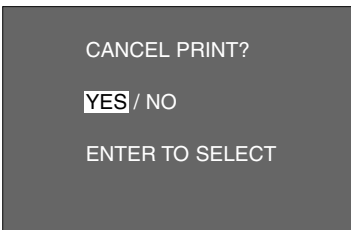

**4** Press the ◀ key so that [YES] is highlighted.

**5** Press the ENTER button.

- The DPOF file including data of the print settings is deleted and all print settings are cancelled.
- After the file is deleted, the LCD monitor display returns to the playback mode menu.

**6** Press the MENU button.

- The LCD monitor display returns to the playback mode.

## FOLDER NAME

---

The folder in the CF card is conformed with DCF (Design rule for Camera File system) format.

When taking a picture with this camera, the “Dcim” folder is made in the directory of the CF card and the “100mlt02” folder is made in the “Dcim” folder. The first captured image is recorded with the file name of “Pict0001.jpg” in the “100mlt02” folder and all the following captured images are also recorded in the “100mlt02” folder. The name of the folder in which the captured images are recorded is displayed on the playback mode menu.

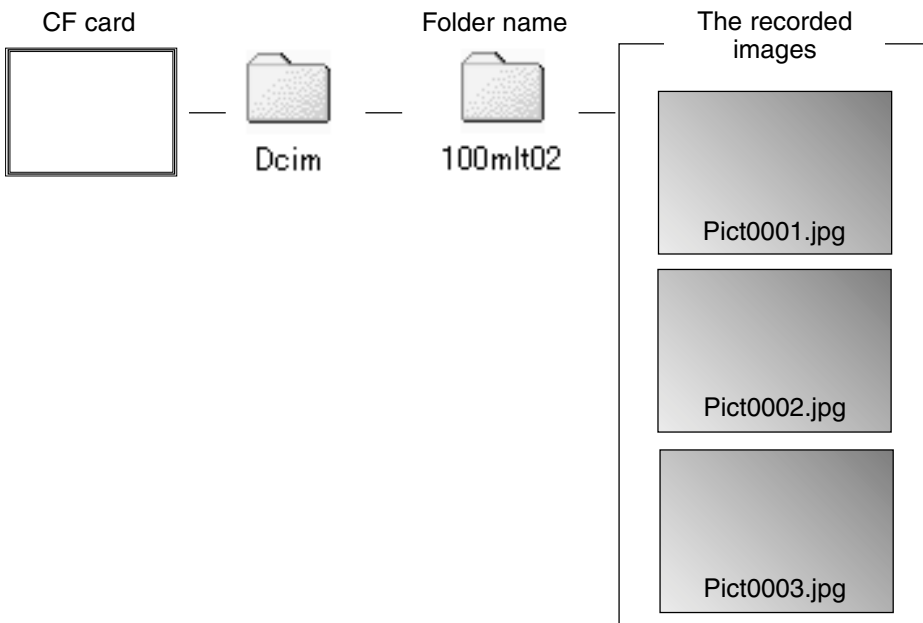

The file name of the image to be recorded consists of “Pict”, “4-digit number” and “.jpg”. The files are recorded in the “100mlt02” folder until the 4-digit number becomes 9999 (the file name of “Pict9999.jpg”). When the 10000th file is recorded, the “101mlt02” folder is newly made in the “Dcim” folder and the 10000th file is recorded with the file name of “Pict0001.jpg” in the “101mlt02” folder.







There will be two folders for the images in one CF card if you capture more than 10000 images. You can select the folder in which the image to be played back is recorded by the folder name displayed in the playback mode menu.

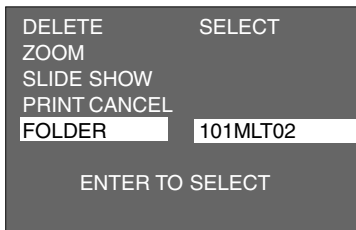
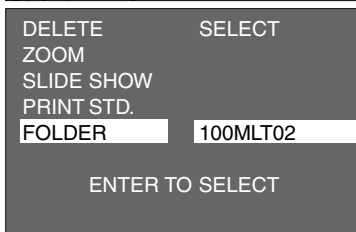
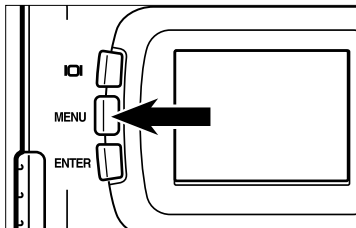

## FOLDER NAME

Even if other digital camera supporting the DCF format is used to record the captured images in the CF card, you can insert the CF card into this camera and play back the images by selecting the particular folder name of other digital camera in the playback mode menu.



- 1 Rotate the function dial to  and press the MENU button.**
  - The playback mode menu is displayed on the LCD monitor.
- 2 Press the  or  key so that [FOLDER] is highlighted and press  key.**
- 3 Press the  key so that the folder name in which the image to be played back is recorded is highlighted and press the ENTER button.**
  - When only "100mlt02" folder exists, the folder name does not change even the  or  key is pressed.

---

## On DCF (Design rule for Camera File system) Format

---

DCF (Design rule for Camera File system) is the image format established by JEIDA as the standard format of digital camera.

Through this format, the image files can be used between the digital equipment conformed to DCF.

The following operation can be available between the digital equipment conformed to DCF:

- The images captured with your digital camera can be played back on the LCD monitor of other digital camera.
- The images captured with some digital cameras can be printed out from a printer.
- A recording media (such as a CF card or SmartMedia™) can be used with any of the digital cameras.
- By using the computer conformed to DCF, even the image data recorded with some digital cameras can be easily sorted out.

---

# SETUP

# THE SETUP MODE MENU DISPLAY

## THE SETUP MODE MENU DISPLAY ON THE LCD MONITOR

LCD BRIGHT	5
POWER SAVE	10 MIN.
FORMAT	
DATE	2000/08/30
TIME	17:33
BEEP	ON
VIDEO OUT	NTSC
LANGUAGE	ENGLISH
DEFAULT	

## THE SETUP MODE MENU ITEMS AND EACH SETTING

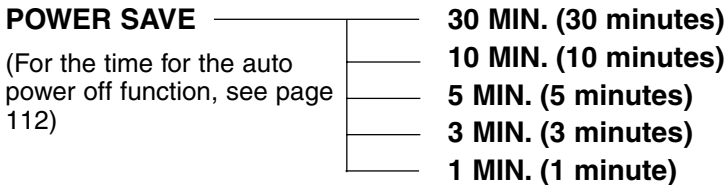
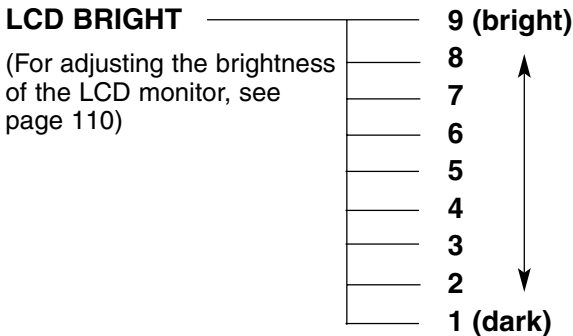

# THE SETUP MODE MENU DISPLAY

---

**FORMAT** \_\_\_\_\_ **NO**  
\_\_\_\_\_  
(For formatting the CF card, see page 114) \_\_\_\_\_ **YES**

**DATE** \_\_\_\_\_ **STYLE** \_\_\_\_\_ **YYYY/MM/DD**  
\_\_\_\_\_  
(For setting or correcting the date and time, see page 116) \_\_\_\_\_ **DD/MM/YYYY**  
\_\_\_\_\_ **MM/DD/YYYY**  
\_\_\_\_\_ **DATE** \_\_\_\_\_ **YYYY/MM/DD**

**TIME** \_\_\_\_\_ **TIME** \_\_\_\_\_ **HH : MM**  
\_\_\_\_\_  
(For setting or correcting the time, see page 116)

**BEEP** \_\_\_\_\_ **ON (The beep sounds.)**  
\_\_\_\_\_  
(For turning on or off the beep, see page 120) \_\_\_\_\_ **OFF (The beep does not sound.)**

**VIDEO OUT** \_\_\_\_\_ **NTSC**  
\_\_\_\_\_  
(For switching the video signal from the video-out terminal, see page 122) \_\_\_\_\_ **PAL**

**LANGUAGE** \_\_\_\_\_ **ENGLISH**  
\_\_\_\_\_  
(For switching the language displayed on the LCD monitor, see page 124) \_\_\_\_\_ **JAPANESE**

**DEFAULT** \_\_\_\_\_ **NO**  
\_\_\_\_\_  
(For resetting the camera, see page 126) \_\_\_\_\_ **YES**

# ADJUSTING THE BRIGHTNESS OF THE LCD MONITOR

This allows you to adjust the brightness of the LCD monitor according to the angle at which you watch it or the brightness around the monitor so that the display on the LCD monitor can be seen clearly.

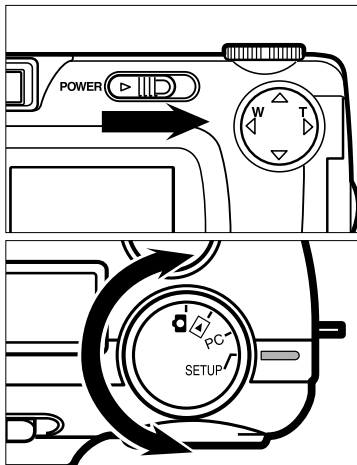

- 1 Rotate the function dial to  and slide the power switch to turn on the camera.**

- The power switch returns to the initial position.

- 2 Rotate the function dial to “SETUP”.**

- The setup mode menu is displayed on the LCD monitor as shown in the figure.

LCD BRIGHT	5
POWER SAVE	3 MIN.
FORMAT	
DATE	2000/08/30
TIME	17:33
BEEP	ON
VIDEO OUT	NTSC
LANGUAGE	ENGLISH
DEFAULT	

- 3 After confirming that [LCD BRIGHT] is highlighted, press the  key.**

- (If the LCD monitor is turned off, the LCD monitor is automatically turned on and) the live view screen and the display to change the brightness of the LCD monitor appear.

# ADJUSTING THE BRIGHTNESS OF THE LCD MONITOR



**4 Press the ▲ or ▼ key so that the desired brightness is highlighted.**

- The brightness can be adjusted in the range from 1 to 9. The smaller the number is, the darker the LCD monitor is while the larger the number is, the brighter the LCD monitor is.
- \* The colour of the background in the left figure is gray so that you can easily find out the contents of the display. However, the live view screen is actually displayed in the background.

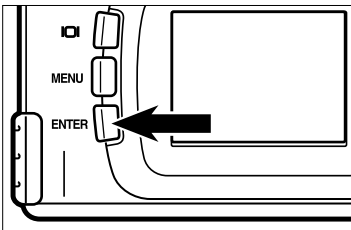

**5 Press the ENTER button.**

- The brightness of the LCD monitor is set to the specified value.
- After setting, the LCD monitor returns to the setup mode menu display.

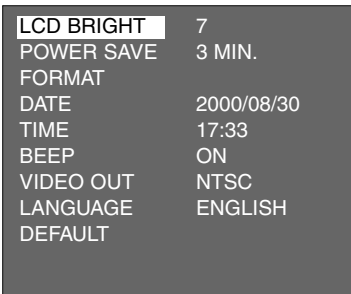

# SPECIFYING THE TIME FOR THE AUTO POWER OFF FUNCTION

To save the battery power, this camera will be turned off automatically if it is not operated more than 3 minutes. (Auto Power Off function) The time for the auto power off function is set to 3 minutes unless you change the setting after you purchase this camera.

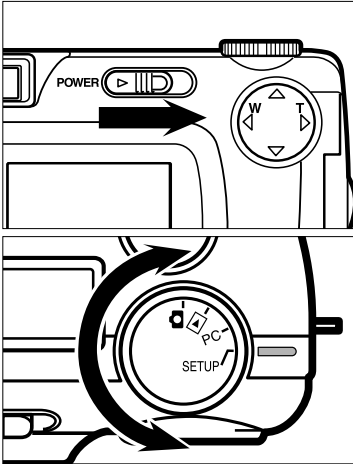



- 1 Rotate the function dial to  and slide the power switch to turn on the camera.**

- The power switch returns to the initial position.

- 2 Rotate the function dial to “SETUP”.**

- The setup mode menu is displayed on the LCD monitor as shown in the figure.

LCD BRIGHT	5
POWER SAVE	3 MIN.
FORMAT	
DATE	2000/08/30
TIME	17:33
BEEP	ON
VIDEO OUT	NTSC
LANGUAGE	ENGLISH
DEFAULT	

- 3 Press the  or  key so that [POWER SAVE] is highlighted and press the  key.**



# SPECIFYING THE TIME FOR THE AUTO POWER OFF FUNCTION

LCD BRIGHT	5
<b>POWER SAVE</b>	3 MIN.
FORMAT	
DATE	2000/08/30
TIME	17:33
BEEP	ON
VIDEO OUT	NTSC
LANGUAGE	ENGLISH
DEFAULT	

4 Press the ▲ or ▼ key so that the desired time for the auto power off function is highlighted.

- The time for the auto power off function changes in the following order.

30 MIN. (30 minutes)



10 MIN. (10 minutes)



5 MIN. (50 minutes)



3 MIN. (3 minutes)



1 MIN. (1 minute)

5 Press the ◀ key.

LCD BRIGHT	5
<b>POWER SAVE</b>	10 MIN.
FORMAT	
DATE	2000/08/30
TIME	17:33
BEEP	ON
VIDEO OUT	NTSC
LANGUAGE	ENGLISH
DEFAULT	

\* Only when using the batteries, the time for the auto power off function can be specified. When using the AC adapter (sold separately), the time for the auto power off function is fixed in 30 minutes and cannot be changed.

\* When this camera is connected to the computer (see pages 132, 142), the time for the auto power off function is fixed 30 minutes automatically regardless of the setting or the power supply.

# FORMATTING THE CF CARD

This allows you to format the CF card.

## CAUTION

As all the images recorded in the CF card are deleted and cannot be recovered, be careful when formatting the CF card.

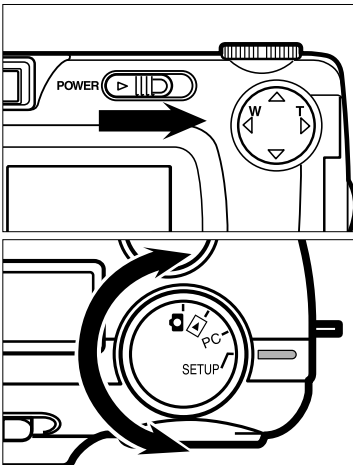

- 1 Rotate the function dial to  and slide the power switch to turn on the camera.**

- The power switch returns to the initial position.

- 2 Rotate the function dial to “SETUP”.**

- The setup mode menu is displayed on the LCD monitor as shown in the figure.

<b>LCD BRIGHT</b>	7
POWER SAVE	10 MIN.
FORMAT	
DATE	2000/08/30
TIME	17:33
BEEP	ON
VIDEO OUT	NTSC
LANGUAGE	ENGLISH
DEFAULT	

# FORMATTING THE CF CARD

---

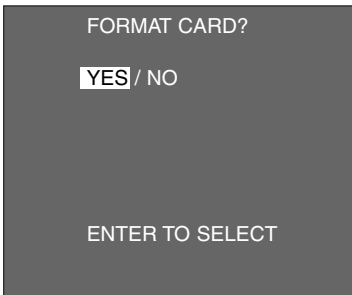
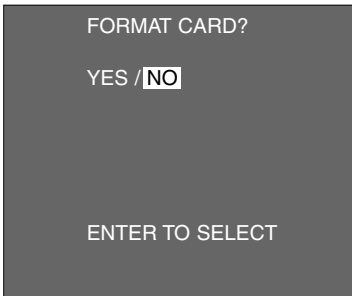
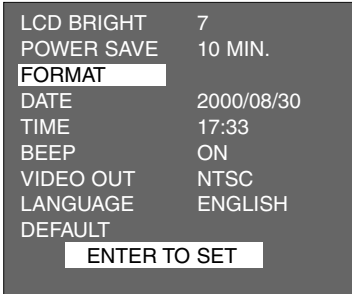

**3** Press the ▲ or ▼ key so that [FORMAT] is highlighted and press the ENTER button.

- The display to confirm whether you format the CF card or not appears.

**4** Press the ◀ key so that [YES] is highlighted and press the ENTER button.

- The format of the CF card starts.
- After formatting the CF card, the LCD monitor returns to the setup mode menu display.

## SETTING THE DATE AND TIME

When taking a picture, the date and time are recorded as the part of the image information. If the built -in clock of this camera is not set correctly, the wrong date and time are recorded. Set the date and time correctly by performing the procedure below.

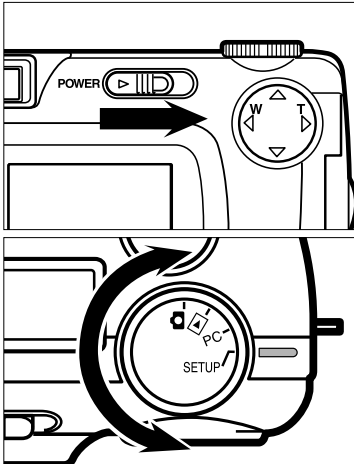

**1 Rotate the function dial to  and slide the power switch to turn on the camera.**

- The power switch returns to the initial position.

**2 Rotate the function dial to “SETUP”.**

- The setup mode menu is displayed on the LCD monitor as shown in the figure.

LCD BRIGHT	7
POWER SAVE	10 MIN.
FORMAT	
DATE	2000/08/30
TIME	17:33
BEEP	ON
VIDEO OUT	NTSC
LANGUAGE	ENGLISH
DEFAULT	

# SETTING THE DATE AND TIME

---

LCD BRIGHT	7
POWER SAVE	10 MIN.
FORMAT	
<b>DATE</b>	<b>2000/08/30</b>
TIME	17:33
BEEP	ON
VIDEO OUT	NTSC
LANGUAGE	ENGLISH
DEFAULT	
<b>ENTER TO ADJUST</b>	

STYLE	YYYY/MM/DD
DATE	2000/08/30
TIME	17:33

▲▼ : SELECT  
◀▶ : ADJUST  
ENTER: SET

STYLE	<b>YYYY/MM/DD</b>
DATE	2000/08/30
TIME	17:33

▲▼ : SELECT  
◀▶ : ADJUST  
ENTER: SET

**3** Press the ▲ or ▼ key so that [DATE] is highlighted and press the ENTER button.

- The display to set the date and time appears as shown in the figure.
- When you specify only the time, press the ▲ or ▼ key so that [TIME] is highlighted and press the ENTER button and go to step [7].

**4** To change the order of year, month and day, press the ◀ key once so that [YYYY/MM/DD] is highlighted.

- If you do not change the order, skip this step and go to step [7].

## SETTING THE DATE AND TIME



**5** Press the ▲ or ▼ key so that the desired order of year, month and day is highlighted.

- The order of year, month and day changes in the following order.

YYYY/MM/DD (year/month/day)



DD/MM/YYYY (day/month/year)



MM/DD/YYYY (month/day/year)

- When the order is changed, the order of the current date displayed on the LCD monitor also changes according to the setting.
- If you do not change the order, skip this step and go to step [7].



**6** Press the ▶ key once.

- The last 2-digit of year is highlighted.
- Each time the ▶ key is pressed, the highlighted part moves in the order of year → month → day → time → minute (s).  
Each time the ◀ key is pressed, the highlighted part moves in the reverse order.

# SETTING THE DATE AND TIME

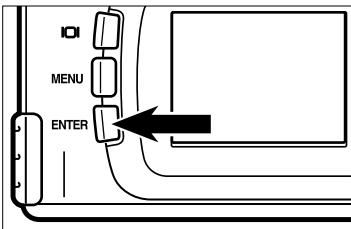

**7** Press the ▲ or ▼ key to specify or correct the date and time.

**When you press and hold the ▲ or ▼ key, the value goes fastforward or fastbackward.**

- The value for year can be specified from 2000 to 2099.
- When other values need to be changed, repeat step [6] and [7].
- If [TIME] is highlighted and the ENTER button is pressed on step 3, the display to specify the date and time appears as shown in the figure. To correct the time, repeat step [6] and [7].

**8** After the date and time is specified (corrected), press the ENTER button.

- The built-in clock of this camera starts functioning. The LCD monitor returns to the setup mode menu.

\* After replacing the batteries, check that the built-in clock (date and time) functions correctly.

If the AC adapter is not used and the battery-chamber door is open for more than 5 minutes, the built-in clock may delay or be reset to the default setting. In this case, set the date and time again.

## SETTING THE BEEP SOUND

The beep sounds each time you operate this camera with the buttons or function dial and you can turn off or on the beep. The beep is turned on unless you change the setting after you purchase this camera. When you use this camera in the situation you cannot make noise such as a wedding ceremony, etc., you can turn off the beep.

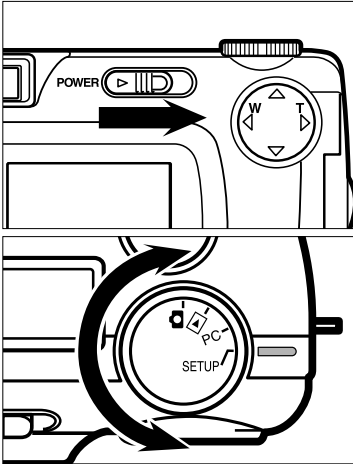

**1 Rotate the function dial to  and slide the power switch to turn on the camera.**

- The power switch returns to the initial position.

**2 Rotate the function dial to “SETUP”.**

- The setup mode menu is displayed on the LCD monitor as shown in the figure.

LCD BRIGHT	7
POWER SAVE	10 MIN.
FORMAT	
DATE	2000/09/30
TIME	17:33
BEEP	ON
VIDEO OUT	NTSC
LANGUAGE	ENGLISH
DEFAULT	



# SETTING THE BEEP SOUND

---

LCD BRIGHT	7
POWER SAVE	10 MIN.
FORMAT	
DATE	2000/09/30
TIME	17:33
<b>BEEP</b>	<b>ON</b>
VIDEO OUT	NTSC
LANGUAGE	ENGLISH
DEFAULT	

- 3** Press the ▲ or ▼ key so that [BEEP] is highlighted and press the ► key.

LCD BRIGHT	7
POWER SAVE	10 MIN.
FORMAT	
DATE	2000/09/30
TIME	17:33
<b>BEEP</b>	<b>OFF</b>
VIDEO OUT	NTSC
LANGUAGE	ENGLISH
DEFAULT	

- 4** Select [ON] or [OFF] with the ▲ or ▼ key.

- The setting of the beep changes in the following order.

ON (The beep sounds.)



OFF (The beep does not sound.)

LCD BRIGHT	7
POWER SAVE	10 MIN.
FORMAT	
DATE	2000/09/30
TIME	17:33
<b>BEEP</b>	<b>OFF</b>
VIDEO OUT	NTSC
LANGUAGE	ENGLISH
DEFAULT	

- 5** Press the ◀ key.

- When [OFF] is selected on step [4], the beep does not sound even when you operate with the buttons or the function dial.
- The volume of the beep cannot be changed.

# SWITCHING THE VIDEO SIGNAL FROM THE VIDEO OUTPUT TERMINAL

As this camera has the video-out terminal, you can watch the captured images on TV by connecting this camera to your TV with the supplied video cable. The video output signal can be switched between NTSC and PAL.

## What is an NTSC system and a PAL system ?

Both are the colour television broadcast system. The NTSC system is mainly used in U.S.A., Japan, Canada, Mexico, the Philippines, Korea, etc. The PAL system is used in the western Europe such as Germany, England, Switzerland, Holland, Italy (except for France) and Australia, Singapore, Thailand, China, etc.

As these systems have no compatibility, you cannot watch the NTSC system based TV in the area where a PAL system is used.

This camera can switch the video output signal to both an NTSC system and a PAL system. So you can watch the images on TV not only in your country, but in other areas.

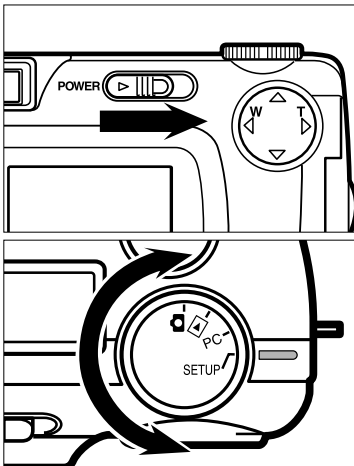

- 1 Rotate the function dial to  and slide the power switch to turn on the camera.**
  - The power switch returns to the initial position.
- 2 Rotate the function dial to “SETUP”.**
  - The setup mode menu is displayed on the LCD monitor.

# SWITCHING THE VIDEO SIGNAL FROM THE VIDEO OUTPUT TERMINAL

---

LCD BRIGHT	7
POWER SAVE	10 MIN.
FORMAT	
DATE	2000/09/30
TIME	17:33
BEEP	ON
<b>VIDEO OUT</b>	<b>NTSC</b>
LANGUAGE	ENGLISH
DEFAULT	

- 3** Press the ▲ or ▼ key so that [VIDEO OUT] is highlighted and press the ► key.

LCD BRIGHT	7
POWER SAVE	10 MIN.
FORMAT	
DATE	2000/09/30
TIME	17:33
BEEP	ON
<b>VIDEO OUT</b>	<b>PAL</b>
LANGUAGE	ENGLISH
DEFAULT	

- 4** Select [NTSC] or [PAL] with the ▲ or ▼ key.

- The setting of the beep changes in the following order.

NTSC



PAL

LCD BRIGHT	7
POWER SAVE	10 MIN.
FORMAT	
DATE	2000/09/30
TIME	17:33
BEEP	ON
<b>VIDEO OUT</b>	<b>PAL</b>
LANGUAGE	ENGLISH
DEFAULT	

- 5** Press the ◀ key.

- The video signal system output from the video-out terminal is switched to the selected one.

# SWITCHING THE LANGUAGE DISPLAYED ON THE LCD MONITOR

The language displayed on the LCD monitor can be switched to Japanese or English.

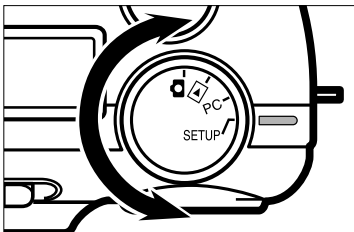
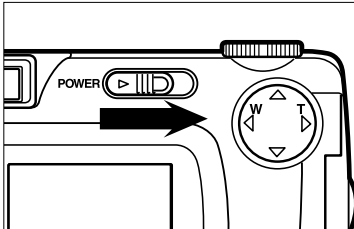



- 1 Rotate the function dial to  and slide the power switch to turn on the camera.**

- The power switch returns to the initial position.

- 2 Rotate the function dial to “SETUP”.**

- The setup mode menu is displayed on the LCD monitor as shown in the figure.

- 3 Press the  or  key so that [LANGUAGE] is highlighted and press the  key.**

LCD BRIGHT	7
POWER SAVE	10 MIN.
FORMAT	
DATE	2000/09/30
TIME	17:33
BEEP	ON
VIDEO OUT	NTSC
<b>LANGUAGE</b>	<b>ENGLISH</b>
DEFAULT	

# SWITCHING THE LANGUAGE DISPLAYED ON THE LCD MONITOR

---

LCD BRIGHT	7
POWER SAVE	10 MIN.
FORMAT	
DATE	2000/09/30
TIME	17:33
BEEP	ON
VIDEO OUT	NTSC
LANGUAGE	JAPANESE
DEFAULT	

LCDアカルサ	7
パワセーブ	10 MIN
フォーマット	
DATE	2000/09/14
TIME	09:48
BEEP	オン
VIDEO OUT	PAL
ゲソゴ	ニホンゴ
シヨキセツテイ	

**4** Select [JAPANESE] or [ENGLISH] with the ▲ or ▼ key.

- The language changes in the following order.

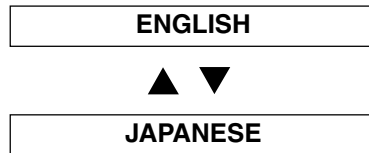

**5** Press the ◀ key.

- The language on displayed on the LCD monitor is switched to the selected one.

## To Return to the English Screen

---

1. Redo steps [1] - [2] described in the previous page.
2. Press the ▲ or ▼ key so that [ゲソゴ] is highlighted and press the ▶ key.
3. Select [イゴ] with the ▲ or ▼ key.
4. Press the ◀ key.

## RESETTING TO THE DEFAULT SETTINGS

---

This allows you to reset all the settings of this camera to the default at a time.

<b>The camera settings</b>	<b>The default settings</b>
Flash mode (see page 41)	Autoflash with red-eye reduction
Exposure compensation value (see page 55)	0
Focus mode (see page 36)	AF (Autofocus)
Drive mode (see page 45)	Single shot
White balance (see page 65)	AUTO
Image quality (see page 60)	STD. (Standard)
Image size (see page 63)	FULL (Full size)
Sharpness (see page 68)	NORMAL
The interval for the slide show mode (see pages 82, 83)	3 seconds
The direction of playback for the slide show (see pages 82, 83)	FORWARD
The brightness of the LCD monitor (see page 110)	5
The time for the auto power off function (see page 112)	3 MIN. (minutes)
The beep sound (see page 120)	ON (The beep sounds)

# RESETTING TO THE DEFAULT SETTINGS

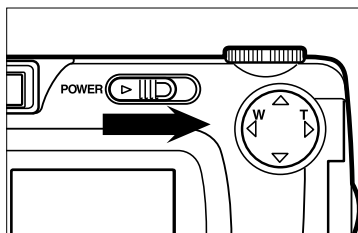

- 1 Rotate the function dial to  and slide the power switch to turn on the camera.

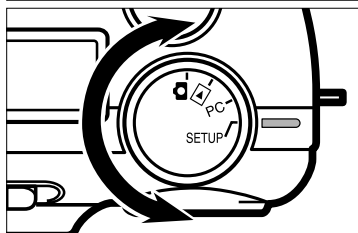

- The power switch returns to the initial position.

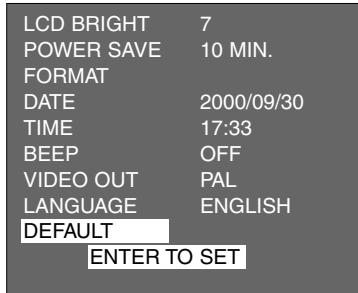

- 2 Rotate the function dial to “SETUP”.

- The setup mode menu is displayed on the LCD monitor as shown in the figure.



- 3 Press the  or  key so that [DEFAULT] is highlighted and press the ENTER button.

- The display to confirm whether you reset the camera settings to the default or not appears.

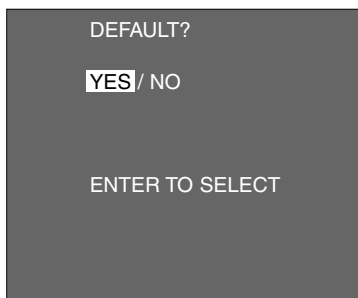

- 4 Press the  key so that [YES] is highlighted and press the ENTER button.

- The camera settings are reset to the default.
- The LCD monitor display returns to the setup mode menu.

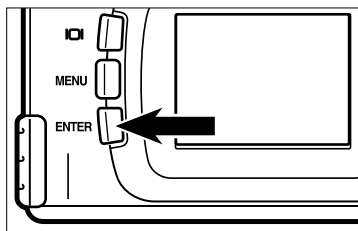

---

# **CONNECTING TO THE PERSONAL COMPUTER**



# CONNECTING TO THE PERSONAL COMPUTER

This camera can be connected to the personal computer by the USB interface.

The CF card in this camera can be detected as a removable disk (removable media) by connecting this camera to the personal computer with the supplied USB cable. According to the OS (Operating System) you use, the installation of driver software is required. See page 131 for details.

You can copy the images from the CF card to the appropriate location of your computer and vice versa using “My Computer” or “Explorer” on Windows®, or dragging and dropping files in the finder on Macintosh.

## For Windows®

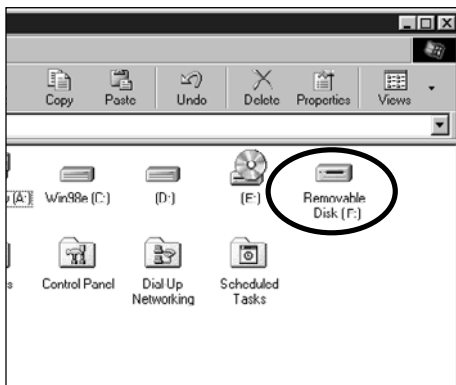

## For Macintosh

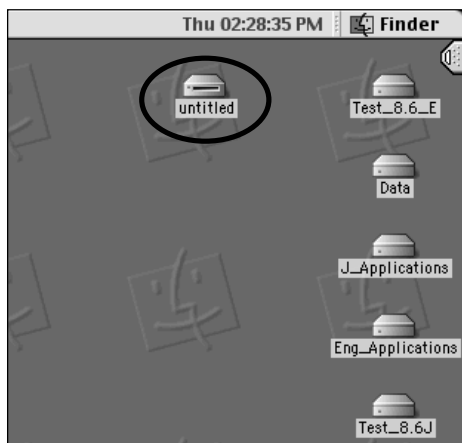

# SYSTEM REQUIREMENTS

---

Before connecting this camera to the computer, check the system of your computer referring to the followings.

<b>For IBM-PC/AT and the compatible unit</b>	
CPU	<p>The IBM-PC/AT and the compatible unit equipped with the USB connector.</p> <p>* Only the CPU which is pre-installed the following operating system described below can be used.</p> <ul style="list-style-type: none"><li>• The custom or home built machines are excepted.</li></ul>
Operating System	Windows®2000 Professional Windows®Me Windows®98/98 Second Edition*

<b>For Macintosh</b>	
CPU	Apple Macintosh series equipped with the USB connector Blue & White Power Macintosh G3 series, Power Macintosh G4 series, iMac series, iBook, PowerBook G3
Operating System	Mac OS 8.6**/9.0/9.0.2/9.0.4

# SYSTEM REQUIREMENTS

---

\* When using Windows®98/Windows®98 Second Edition, you need to install the driver software from the supplied CD-ROM (see pages 133 - 137).

\*\*When using Mac Os 8.6, you need to install “USB Mass Storage Support 1.3.5” after downloading it from the web site of Apple Computer:

**<http://asu.info.apple.com/swupdates.nsf/artnum/n11418>**

This software is provided by Apple Computer for free of charge.  
Use this after reading the caution on the web site, the condition of usage and the way of installation, etc.



USB Storage Support 1.3.5.smi

## CONNECTING TO THE PERSONAL COMPUTER

---

- 1 Turn on the power of the computer to be connected and start up the operating system (Windows®/Mac OS).

- 2 Confirm that the CF card is inserted in the camera.

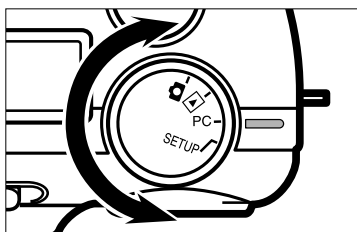

- 3 Rotate the function dial to “PC”.
  - Be sure to rotate the function dial to PC before turning on the camera. Otherwise, the connection cannot be performed correctly.

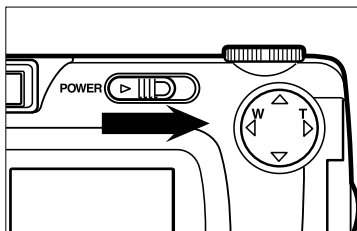

- 4 Slide the power switch to turn on the camera.
  - The power switch returns to the initial position.
  - “USB” appears on the data panel and shows that the camera enters the PC connecting mode as shown in the figure below.

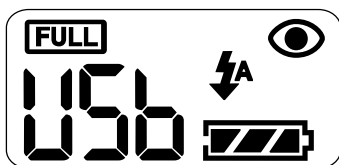

# CONNECTING TO THE PERSONAL COMPUTER

---

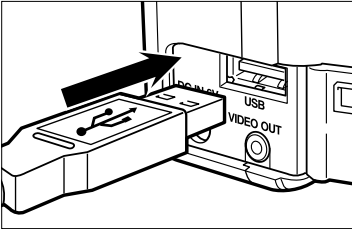

- 5** Open the terminal cover and connect one side of the supplied USB cable to the USB connector of this camera.
- As the both sides of USB connector are the same shape, you can connect either side of the USB connector.
  - Connect the USB connector securely. Otherwise, the operation cannot be performed correctly.

- 6** Connect the other side of the supplied USB cable to the USB port of the computer.
- Connect the USB connector securely. Otherwise, the operation cannot be performed correctly.
  - If you connect the camera to the computer via the USB hub, the operation may not be performed correctly depending on the condition of other USB equipment or the USB hub. We recommend you to connect to the USB port of the computer directly.



When using Windows®98/Windows®98 Second Edition and connecting this camera to the computer with the USB cable, “Add New Hardware Wizard” dialog box appears as shown in the figure. Install the driver software by following the indication of the dialog box (refer to the procedure described on the following pages).

# CONNECTING TO THE PERSONAL COMPUTER

## INSTALLATION OF THE DRIVER SOFTWARE

The following operation is required only when Windows®98/Windows®98 Second Edition is used. When Windows®2000 Professional or Windows®Me is used, the operation described on pages 134 to 137 is not necessary because the necessary driver software is installed automatically.



- 1 When “Add New Hardware Wizard” dialog box appears, click [Next>].



- 2 When the dialog box as shown on the left appears, select “Search for the best driver for your device. (Recommended)” and click [Next>].



- 3 When the dialog box as shown on the left appears, insert the Dimâge 2330 ZOOM CD-ROM into the CD-ROM drive and put the check mark on “CD-ROM drive” and click [Next>].

# CONNECTING TO THE PERSONAL COMPUTER



4 When the device driver is detected and the dialog box as shown on the left appears, Click [Next>].



5 When the installation of the driver software is completed and the dialog box as shown on the left appears, click [Finish].



6 When “Add New Hardware Wizard” appears again, click [Next>].



7 When the dialog box as shown on the left appears, select “Search for the best driver for your device. (Recommended)” and click [Next>].

# CONNECTING TO THE PERSONAL COMPUTER



- 8 When the dialog box as shown on the left appears, confirm that “CD-ROM drive” is checkmarked and click [Next>].



- 9 When the device driver is detected and the dialog box as shown on the left appears, Click [Next>].



- 10 When the installation of the driver software is completed and the dialog box as shown on the left appears, click [Finish].



- 11 When “Add New Hardware Wizard” appears again, click [Next>].



# CONNECTING TO THE PERSONAL COMPUTER



- 12 When the dialog box as shown on the left appears, select “Search for the best driver for your device. (Recommended)” and click [Next>].



- 13 When the dialog box as shown on the left appears, confirm that “CD-ROM drive” is checkmarked and click [Next>].



- 14 When the device driver is detected and the dialog box as shown on the left appears, Click [Next>].



- 15 When the installation of the driver software is completed and the dialog box as shown on the left appears, click [Finish].  
The installation of the driver software is completed.

# CONNECTING TO THE PERSONAL COMPUTER

On Windows®, when this camera is connected to the computer correctly (and the driver software is installed correctly if you use the Windows®98/98 Second Edition), the CF card in this camera is detected as the removable disk and the icon of “Removable disk” is displayed in “My Computer” on Windows® as shown below.

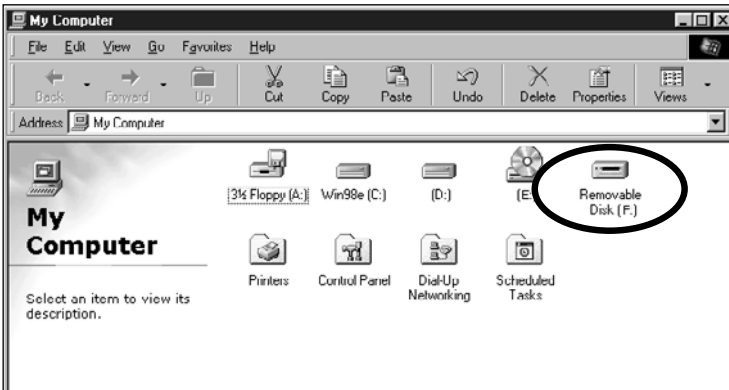

On Macintosh, when this camera is connected to the computer correctly, the CF card in this camera is detected as the removable media and mounted in the finder on Macintosh as shown below.

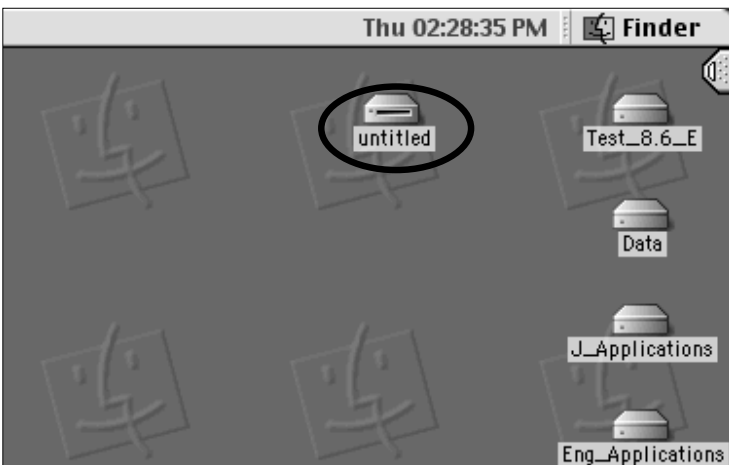

## CONNECTING TO THE PERSONAL COMPUTER

By dragging and dropping the data, you can copy the images from the CF card to the appropriate location of your computer and vice versa in “My Computer” or “Explorer” on Windows® or in the finder on Macintosh.

- \* When the icon of the “Removable disk” is not displayed or when the removable media is not mounted, restart your computer.
- \* The image file is saved in the “100mlt02” folder of the “Dcim” folder of the removable disk (media).
- \* For the operation of copying a file in “My computer”, “Explorer” or in the finder, refer to the operating instruction manual supplied with the computer, “Help”, etc.

### **When this camera cannot be connected to the computer correctly, check the followings:**

- Is the camera set to the PC connecting mode ?
  - Rotate the function dial to PC and turn on the power of the camera. (See page 132)
- Is the power of the camera turned on ?
  - Connect them when the power of the camera and the computer is turned on.
- Is the CF card inserted into the camera ?
  - Insert the CF card into the camera correctly. (See page 28)
- Is the USB cable connected to the USB connector of the camera and the USB port of the computer securely ?
  - Connect the USB cable securely. (See page 133)
- Is the camera connected to the computer via the USB hub ?
  - Connect to the USB port of the computer directly. Otherwise, the operation may not be performed correctly depending on the condition of other USB equipment or the USB hub.

If there is no problem with the items described above, connect the camera to the computer again following the procedure described on page 132.

# WHEN DISCONNECTING THE USB CABLE

---

When disconnecting the USB cable, perform the procedure as described below.

## For Windows®98/Windows®98 Second Edition

---

1 **Confirm that the focus lamp (green) does not light or blink** and then disconnect the USB cable.

## For Windows®2000 Professional

---

1 Click the “Unplug or Eject Hardware” icon displayed on the task bar on the lower right of the screen using the right button of the mouse and click “Unplug or Eject Hardware” using the left button of the mouse. Or double click the icon of “Unplug or Eject Hardware”.

2 In the dialog box to Unplug or Eject Hardware, select “USB Mass Storage Device” using the left button of the mouse and click “Stop” using the left button of the mouse.

3 In the dialog box to Stop a Hardware device, select “MINOLTA DIMAGE 2330 ZOOM USB Device” using the left button of the mouse and click “OK” using the left button of the mouse.

4 When the message of “The ‘USB Mass Storage Device’ device can now be safely removed from the system.” appears, click “OK” using the left button of the mouse.

5 Disconnect the USB cable.

## For Windows®Me

---

1 Click the “Unplug or Eject Hardware” icon displayed on the task bar on the lower right of the screen using the right button of the mouse and click “Unplug or Eject Hardware” using the left button of the mouse. Or double click the icon of “Unplug or Eject Hardware”.

2 In the dialog box to Unplug or Eject Hardware, select “USB Disk” using the left button of the mouse and click “Stop” using the left button of the mouse.

3 In the dialog box to Stop a Hardware device, select “MINOLTA DIMAGE 2330 ZOOM:” using the left button of the mouse and click “OK” using the left button of the mouse.

4 When the message of “The ‘USB Disk E:’ device can now be safely removed from the system.” appears, click “OK” using the left button of the mouse.

5 Disconnect the USB cable.

• *In this case, “Drive E:” is allocated to the Removable Disk (i.e. CF card in the Dimâge 2330 ZOOM). This drive letter may vary depending on your PC system.*

# WHEN DISCONNECTING THE USB CABLE

---

## For Macintosh

---

1 **Confirm that the focus lamp (green) does not light or blink** and then drag the icon of the removable media and drop it to “Trash”.

- The same icon is displayed again on the desk top.

2 Disconnect the USB cable.

- When the USB cable is disconnected without performing step 1, the alerting message appears. So be sure to perform step 1 before disconnecting the USB cable. (However, you can go on the procedure if you click “OK” even when the alerting message is displayed.)

# CAUTIONS WHEN CONNECTING TO THE PERSONAL COMPUTER

---

- While this camera is connected to the computer or transferring the image data between this camera and the computer, do not perform the following operations. Otherwise, the error may occur, the camera and the computer may not function correctly, or the image data recorded in the CF card may be erased or damaged.
  - Turn off the power of the camera
  - Disconnect the USB cable
  - Rotate the function dial
  - Remove or insert the CF card
- 
- When disconnecting the USB cable, be sure to confirm that the focus lamp (green) does not light or blink, and perform the procedure described on pages from 140 to 141.

Especially for Windows®2000 Professional, be sure to confirm that the access lamp of the hard disk does not light (it does not access to the hard disc) and perform the procedure described on pages from 140 to 141

On Windows®2000 Professional, the data transfer is not actually completed due to the delay of writing even when the display on the computer shows that copying is finished. As the data is transferred for a while even after the copying message disappears, do not turn off the power of the camera, disconnect the USB cable or rotate the function dial during the time. Otherwise, the error may occur, and the camera and the computer may not function correctly.

- When the camera is connected to the computer, the time for the auto power off function is fixed in 30 minutes automatically regardless of the power supply you use or the settings in the SETUP mode (see page 113).

## **CAUTIONS WHEN CONNECTING TO THE PERSONAL COMPUTER**

---

- When connecting the camera to the computer and transferring the image data between them, be sure to check that the battery capacity is full. If the battery power is low, the power of the camera may be turned off while transferring data. If this happens, the error may occur, the camera and the computer may not function correctly, or the image data recorded in the CF card may be erased or damaged.

When the camera is connected to the computer, we recommend you to use new batteries with a full power capacity or the AC adapter AC-2 (sold separately).

# INSTALLING ADOBE PHOTODELUXE

---

To use the supplied image editing application Adobe PhotoDeluxe 4.0 Family Edition (Windows® version) or Adobe PhotoDeluxe 2.0 (Macintosh version), the following systems are required.

## For the IBM-PC/AT and the compatible unit

CPU	Intel Pentium II processor of 233 MHz or more, or the computer equipped with the fully compatible processor.
OS	Windows®95, Windows®98, Windows®NT 4.0 (Service Pack 5)
Memory	32 MB or more of built-in memory (For Windows®NT, 64 MB or more of built-in memory).
Hard disk space	100 MB or more of available hard disk space.
Monitor	Resolution 800 x 600/the colour monitor for 16-bit colour video display
CD-ROM drive	Necessary (when installing and using the software)

## For Apple Macintosh

CPU	68040 or later processor or better, or Macintosh or Power Macintosh
OS	Mac OS 8
Memory	A minimum of 16 MB in addition to the requirements for the Mac OS.
Hard disk space	70 MB or more of available hard disk space.
Monitor	The colour monitor capable of displaying 256 colours.
CD-ROM drive	Necessary (when installing and using the software).



# INSTALLING ADOBE PHOTODELUXE

---

**If you have some problems or difficulties about installing Adobe PhotoDeluxe, please contact to Adobe Systems Inc., <http://www.adobe.com/>.**

## Installing to the IBM-PC/AT and the compatible unit

---

- 1 Turn on the computer and start up Windows®.
- 2 Insert the Adobe PhotoDeluxe 4.0 CD-ROM into the CD-ROM drive.
- 3 When the setup program starts up automatically (Auto-Run), click [Next>].  
After that, follow the operations according to the indication displayed on the screen.

\* When the setup program does not start up automatically, select “Start” → “Run” and input “D:\ENGLISH\INSTALL\SETUP.EXE” in the box of “Open” (when your CD-ROM drive is the D drive) and click [OK].

## Installing to the Apple Macintosh

---

- 1 Turn on the computer and start up Mac OS.
- 2 Insert the Adobe Photodeluxe 2.0 CD-ROM into the CD-ROM drive.
- 3 When the icon of Adobe PhotoDeluxe 2.0 CD-ROM is displayed on the desk top, double-click its icon.
- 4 Double-click “English” folder to open it.
- 5 Double-click “PhotoDeluxe™ Installer” icon.  
After that, follow the operations according to the indication displayed on the screen.

---

# APPENDIX

## WATCHING THE CAPTURED IMAGES ON TV

---

By connecting this camera to your TV with the supplied video cable, you can watch the captured images on TV.

- 1** Confirm that the video out signal from the video-out terminal is set to NTSC or PAL according to the colour system in your country. (see page 122).
- 2** Turn off the power of the this camera and TV.
- 3** Open the terminal cover on the left side of the camera and connect the mini plug of the supplied video cable to the video-out terminal of the camera.
  - The LCD monitor is turned off.
- 4** Connect the other side of the video cable to the video input terminal on TV.
- 5** Turn on the power of TV.
- 6** Rotate the function dial to .
- 7** Slide the power switch to turn on the camera.
- 8** Switch the video input of TV according to the terminal to which the video cable is connected.
  - The images recorded in the CF card can be displayed both on the LCD monitor and TV.
- 9** You can watch the images in the various play modes performing the procedure described on pages from 71 to 78.
  - The images can be played back in the slide show mode (see page 79), etc.

# TROUBLESHOOTING

If you have any trouble with this camera, check the following items. Should the difficulty persist, contact the Minolta Service Facility listed on the back cover of this manual.

Problem	Check	Solution	Page
<p>The focus cannot be adjusted in the autofocus mode (The focus lamp (green) blinks quickly (about 8 times in a second) when the shutter-release button is pressed part-way down.</p>	<p>Do you attempt to adjust the focus on the subject which is difficult to focus in the autofocus mode?</p>	<p>Take a picture with the focus lock function or in the manual focus mode.</p>	<p>38 39</p>
	<p>Do you attempt to take a picture when the subject is closer than the minimum focus distance (40 cm), or farther than 40 cm in the close up mode?</p>	<p>Take a picture when the subject is farther than 40 cm, or when the subject is within the distance from 4 cm to 40 cm (is not apart more than 40 cm from the camera) in the close up mode.</p>	<p>36</p>
<p>The shutter-release button is not released.</p>	<p>Is the power of the camera turned off?</p>	<p>Rotate the function dial to  and slide the power switch to turn on the camera.</p>	<p>32</p>
	<p>Is the camera set to other mode except the recording mode?</p>		
	<p>Is the focus lamp (green) blinks slowly (about 2 times in a second) and "Recording" blinking on the LCD monitor?</p>	<p>The image is recorded in the CF card. Wait until the recording is completed and the focus lamp (green) and "Recording" stop blinking.</p>	<p>33</p>



# TROUBLESHOOTING

Problem	Check	Solution	Page
The shutter-release button is not released.	Is "CARD FULL" displayed on the LCD monitor?	The CF card is full. Delete unwanted images or transfer the image data to the computer and then delete all images, or use other CF card which has a memory space.	86 90
The live view is not displayed on the LCD monitor.	Is the power of the camera turned off?	Rotate the function dial to  and slide the power switch to turn on the camera.	32
	Are the batteries exhausted?	Replace all four batteries or use the AC adapter (sold separately).	24 27
	Are the batteries inserted with the correct polarity?	Remove the batteries and then insert the batteries by following the +/- diagram indicated in front of the battery-chamber door.	24
	Is the LCD monitor turned off?	Press the display button to turn on the monitor.	34
	The auto power off function activates.	Slide the power switch to turn on the camera again.	27

# TROUBLESHOOTING

Problem	Check	Solution	Page
The image cannot be played back on the LCD monitor.	Is the power of the camera turned off?	Rotate the function dial to  and slide the power switch to turn on the camera.	71
	Are the batteries exhausted?	Replace all four batteries or use the AC adapter (sold separately).	24 27
	Are the batteries inserted with the correct polarity?	Remove the batteries and then insert the batteries by following the +/- diagram indicated in front of the battery-chamber door.	24
	Is the CF card is inserted in the camera? (Is "NO CARD" displayed on the LCD monitor?)	When "NO CARD" is displayed on the LCD monitor and "CF" is displayed on the data panel, the CF card is not set. Insert the CF card.	28
	The auto power off function activates.	Slide the power switch to turn on the camera again.	27
	Is the focus lamp (green) blinks slowly (about 2 times in a second) and "PLAY BACK" blinks on the LCD monitor?	The camera reads out the image data from the CF card. Wait until the reading is completed and the focus lamp and "PLAY BACK" stop blinking.	15
The image recorded in the flash mode is dark.	Did you take a picture within the flash range?	Take a picture within the flash range (0.4 to 3 m).	41

# TROUBLESHOOTING

Problem	Check	Solution	Page
The zoom play cannot be performed.	Did you take a picture with the digital zoom function?	The picture captured with the digital zoom function cannot be played back in the zoom play mode.	51 78
The image is too dark or bright.	Is the exposure compensation value specified?	Specify 0 for the exposure compensation value.	55
Even when the lens comes out, the data panel is turned off and the camera can not function.	Has the  battery-condition indicator blinked (all the indicators disappeared after 5 seconds)?	If the  battery-condition indicator blinks, all the indicators will disappear after 5 seconds while the lens is protruding.	26
The recorded image file is damaged.	Did you remove the CF card when the image data was recorded in or read out from the CF card?	The data is being recorded in or read out from the CF card while the focus lamp (green) blinks slowly (about 2 times in a second). Do not remove the CF card from the camera.	33
The camera does not function correctly due to the strong static electricity, etc.	Remove the batteries and insert them again. When using the AC adapter (sold separately), disconnect the plug of the AC adapter from the AC outlet and then connect it again. After that, turn on the power of the camera. * If the power of the camera cannot be turned off correctly, the CF card may be damaged. In this case, transfer the image data in the CF card to the computer and then format the CF card.		--

# NOTES ON THE HANDLING

---

## Batteries

- Battery performance decreases with lower operating temperatures. In a cold place, we recommend you to prepare new batteries and keep the spare batteries in a warm place such as inside your coat.

As the performance of Ni-MH battery less decreases, we recommend you to use the Ni-MH battery in a cold place. Even if the battery performance decreases due to a cold environment, the battery can recover its power when the battery warms up.

- Remove the batteries when they are not in use for an extended period. The battery leakage may damage the battery-chamber.
- Occasionally, when using alkaline batteries, the battery-condition indicator shows that the battery power is low even if there is enough power capacity. Continue to use the camera. The low-battery symbol will disappear.
- As the batteries heat up just after the camera is used, be careful when removing or replacing the batteries. Turn off the power of the camera and allow the batteries to cool down.

## Battery Performance

- The recordable frames: about 120 frames

Test condition:

Temperature:	20°C/68°F
Batteries:	4 AA-size alkaline batteries (supplied accessory)
LCD monitor:	ON

- The playback time: Approx. 100 minutes

Test condition:

Temperature:	20°C/68°F
Batteries:	4 AA-size alkaline batteries (supplied accessory)
LCD monitor:	displaying images sequentially

\* The values given above is determined by Minolta tests.

\* The battery performance may differ from the values given above upon the brand/grade of battery used, operating temperatures, etc.



# NOTES ON THE HANDLING

---

## Operating Temperatures and Conditions

- This camera has been designed for use in temperatures from 0°C to 40°C (32°F to 104°F).
- Never leave the camera exposed to extreme high temperatures, such as in a car parked in the sun, or to extreme humidity.
- To prevent condensation from forming, place the camera in a sealed, plastic bag when bringing it from a cold place to a warm place. Allow it to come to room temperature before removing it from the bag.

## Safety and Handling for the CF card

- Read and follow the instructions manual supplied with the CF card.
- The following may cause data loss or damage. **We have no responsibility for it.** We recommend you to copy a backup data in other media such as ZIP disc, hard disk, CD-ROM, etc.
  - 1 Improper use of card.
  - 2 Static electrical discharge near card or electric noise.
  - 3 Removing the card or interrupting power supply while camera or equipment is accessing the card (reading, writing, formatting etc.).
  - 4 Non-use of card for an extended period.
  - 5 Using the card over its life
- When the card is formatted, the recorded data is deleted. Be sure to record a backup data if it is necessary.
- The storage capability of the CF card will diminish with extended use. In this case, buy a new card.
- Keep away from static electricity and electric noise.
- Do not bend, drop, or subject the card to impact.
- The strong static electricity or shock may damage the card so that recording or writing in the card cannot be performed. In this case, buy a new card.
- Do not touch the electrical contacts of the card with your fingers or a metal object.
- Keep away from heat, moisture, and direct sunlight.
- Keep away from small children.
- When not in use, return the card to its protective case.

# NOTES ON THE HANDLING

---

## LCD Monitor Care

- The LCD monitor is manufactured using high precision technology. However, there may rarely be a lack of colour or bright points on the LCD monitor.
- Do not apply pressure on the surface of the LCD monitor. Permanent damage may occur.
- In a cold environment, the LCD monitor may be temporarily dark. When the camera warms up, normal display will be restored.
- The LCD monitor may be slow to react in a low temperature or may be dark in a hot environment. When the camera warms up, normal display will be restored.
- If there are fingerprints on the LCD monitor surface, gently wipe it with a soft, clean, dry cloth.

## Copyright

- TV program, films, video tapes, and other materials may be copy righted. Unauthorized recording of such materials may be contrary to the provision of the copyright laws. And in some performance and exhibition, etc. taking pictures are prohibited. The image which has a copyright cannot be used except for the use within the copyright laws.

## DPOF

- If the CF card including the DPOF data specified by other camera is set in this camera, the DPOF data will be cancelled.
- Even if you insert the CF card including the data recorded with other digital camera supporting the DCF format, the DPOF data for the images captured with other digital camera (the images in the folder made by other digital camera supporting the DCF format) cannot be specified in this camera.

# NOTES ON THE HANDLING

---

## Others

- Do not subject the camera to shock or impact.
- Turn off the power of the camera when transporting.
- This camera is neither waterproof nor splashproof.

Inserting or removing batteries and the CF card, or operating the camera with wet hands may damage the camera.

When using the camera at the beach or near water, take care not to drop water or sand on the camera. If water, sand, dust or salt content accumulates on the camera, it may cause the malfunction.

- Do not leave the camera under direct sunlight. Do not point the lens at direct sunlight. Doing so, CCD may be damaged.

# CARE AND STORAGE

---

## Cleaning

- If the camera or the outside of the lens is dirty, gently wipe it with a soft, clean, dry cloth. If the camera or lens comes in contact with sand, gently blow away loose particles. Wiping may scratch the surface.
- To clean the lens surface, first blow away any dust or sand, then, if necessary, moisten a lens tissue or soft cloth with lens cleaning fluid and gently wipe the lens.
- Never use organic solvents to clean the camera.
- Never touch the lens surface with your fingers.

## Storage

- Store in a cool, dry and well-ventilated place away from dust and chemicals. For very long periods, store the camera in an airtight container with a silica gel drying agent.
- Remove the batteries or the CF card from the camera when not in use for an extended period.
- Do not store the camera in the closet with mothballs.
- We recommend you to press the shutter-release button sometimes during the storage. Also, check the camera's operation to make sure it is functioning properly before using.

## Before Important Events such as a Wedding Ceremony, Overseas Travel

- We recommend you to check the camera's operation beforehand or take test pictures, and to prepare spare batteries.
- Minolta has no responsibility for damages incurred by equipment malfunction.

## Questions and Service

- If you have questions about your camera, contact your local camera dealer or write to the Minolta distributor in your area.
- Before shipping your camera for repair, please contact a Minolta Service Facility for details.

# TECHNICAL DETAILS

---

## Camera Type

Removable recording media type digital camera with LCD monitor, built-in flash

## CCD

### Pickup elements:

1/1.75 inch-type inter line CCD, 2,310,000 pixels, with a base colour filter

### Pickup system:

single

### ISO sensitivity:

Equivalent to ISO 100

### Number of bit converted to A/D:

10 bit

## Lens Unit

**Focal length:** 8 to 24 mm (38 to 114 mm in the 35mm film format equivalent)

**Aperture:** F 3.4 to 3.6

**Construction:** 9 elements in 6 groups including 3 aspheric surfaces

**Focusing range:** 40 cm to infinity (The close up mode: 4 cm to 40 cm)

**Digital zoom:** maximum zoom in the telephoto mode X2.5

## Image Storage

### Recording medium:

CF card (Type I)

### Image file format:

Exif 2.1 (JPEG), DCF standards, DPOF 1.0

### Number of pixels (W x H):

1,792 x 1,200 pixels (Full size),

896 x 600 pixels (Half size)

### Storage capacity (Using a 8 MB CF card):

	Full size	Half size
FINE	approx. 8 images	approx. 28 images
STD. (Standard)	approx. 13 images	approx. 43 images
ECON. (Economy)	approx. 33 images	approx. 99 images

The number of images to be recorded varies depending on the subject.

### Others:

Delete function (Single image, All images)

Format function for the CF card

# TECHNICAL DETAILS

---

## Autofocus

- System:** AF system by CCD  
Focus locked when the shutter-release button is pressed halfway.
- Focus mode:** One shot AF
- Manual Focus:** Available (operated with ◀, ▶, ▲ and ▼ keys.)

## Auto Exposure (AE) Control

- Exposure mode:** Programmed AE  
AE locked when the shutter-release button is pressed halfway.
- Metering:** Center weighted TTL metering
- Shutter:** CCD electrical shutter (with a Mechanical shutter)  
Shutter speed: 1/500 sec. to 1 sec.
- Exposure compensation:**  
±2EV in 0.5 EV increments
- White balance:** Automatic, Manual setting available (outdoors, tungsten, fluorescent)

## LCD Monitor

- Type:** 46 mm (1.8-inch) TFT-LCD module
- Pixels:** Approx. 60,000
- Bright level:** 9 steps
- Language display:** Switchable between English and Japanese
- Display:** Single frame display, index display (9 frames), slide show, magnification display (the zoom play, X2.5, changing magnification area available)

## Viewfinder

- Type:** Real image zoom finder
- Field of view (3 m):** Approx. 80%
- Eye-relief:** 14 mm
- Magnification:** X 0.35 to X1.0

# TECHNICAL DETAILS

---

## Drive Mode

**Mode:** Single shot, sequence shot (approx. 1 frame/sec.), self-timer shot

**The recordable number of images:**

Full size	Half size	
FINE	Approx. 2 frames	Approx. 6 frames
STD. (Standard)	Approx. 4 frames	Approx. 12 frames
ECON. (Economy)	Approx. 8 frames	Approx. 12 frames

**Self-timer:** Approx. 10 seconds delayed release

## Built-in Flash

**Charge time:** Approx. 8 seconds at fill flash

**Flash modes:** Autoflash, Fill-flash, Flash cancel, Autoflash with red-eye reduction, Fill-flash with red-eye reduction (Flash cancel in the close up mode)

**Flash intensity control:**

Adjusted automatically by an external light

## Interface

**Video output:** Composite video signal, switchable between NTSC and PAL

**PC interface:** USB port

## Power Supply

**Batteries:** AA-sized alkaline battery x 4 or AA-sized Ni-MH battery x 4 (AA-sized lithium battery is not available.)

**External power:** AC adapter (supplied) available (a DC terminal is provided on the camera body.)

**Operating temperature:**

0 to 40°C (32 to 104°F)

## Dimensions and Weight

**Dimensions (W x H x D) :**

116 x 73 x 62 mm (4.57 x 2.87 x 2.44 inches) (not including the projecting parts)

**Weight:**

Approx. 280g (9.88 oz.) (without batteries and the CF card)

Specifications are based on the latest information available at the time of printing and are subject to change without notice.

A	<p>Minolta Austria Ges.m.b.H  Amalienstr. 59-61, A-1131 Wien, Österreich  Tel: 01 87868 176  Fax: 01 87868 153  <a href="http://www.minoltaeurope.com">http://www.minoltaeurope.com</a></p>	GB	<p>Minolta (UK) LTD. Photographic Division  Precedent Drive,  Rooksley, Milton Keynes, MK13 8HF,  England  Tel: 01 908 208 349  Fax: 01 908 208 334  <a href="http://www.minoltaeurope.com">http://www.minoltaeurope.com</a></p>
B	<p>Minolta Belgium Branch  Prins Boudewijnlaan 1  B-2550 Kontich, België  Tel: 03 451 07 00  Fax: 03 458 50 48  <a href="http://www.minolta.be">http://www.minolta.be</a>  <a href="http://www.minolta.nl">http://www.minolta.nl</a></p>	IRL	<p>Photopak Sales  241 Western Industrial Estate, Naas Road,  Dublin 12, Ireland  Tel: 01 45 66 400  Fax: 01 45 00 452  <a href="http://www.minoltaeurope.com">http://www.minoltaeurope.com</a></p>
CAN	<p>Minolta Canada Inc., Head Office  369 Britannia Road East,  Mississauga, Ontario L4Z 2H5, Canada  Tel. 0905 890 66 00  Fax 0905 890 71 99  <a href="http://www.minolta.com">http://www.minolta.com</a></p>	I	<p>Rossi &amp; C. S.p.A.  Via Ticino 40,  I – 50019 Osmannoro Sesto Fiorentino (Fi),  Italy  Tel.: 055 323141  Fax: 055 32314252  <a href="http://www.minoltafoto.it">http://www.minoltafoto.it</a></p>
CH	<p>Minolta (Schweiz) AG  Riedstr. 6, CH-8953 Dietikon, Schweiz  Tel: 157 57 11 (sFr 2.15/min)  Fax: 01 741 33 12  <a href="http://www.minolta.ch">http://www.minolta.ch</a></p>	N	<p>Scandiafilm AS  Enebakkveien 304, N-1188 Oslo 11, Norge  Tel: 022 28 00 00  Fax: 022 28 17 42  <a href="http://www.minoltaeurope.com">http://www.minoltaeurope.com</a></p>
D	<p>Minolta Europe GmbH  Minoltaring 11,  D-30855 Langenhagen, Deutschland  Reparatur/Repair  Senator-Helmken-Strasse 1,  D-28279 Bremen, Deutschland  Hotline: Tel: 0221 5 60 60 31  Fax: 0221 5 60 60 40  <a href="http://www.minolta.de">http://www.minolta.de</a></p>	NL	<p>Minolta Camera Benelux B.V.  Zonnebaan 39, Postbus 6000  3600 HA Maarssen, Nederland  Tel: 030 247 08 09  Fax: 030 247 08 88  <a href="http://www.minolta.nl">http://www.minolta.nl</a></p>
DK	<p>Paul Westheimer A/S  Erhvervsvej 30, DK-2610 Rødovre, Danmark  Tel: 44 85 34 00  Fax: 44 85 34 01  <a href="http://www.minoltaeurope.com">http://www.minoltaeurope.com</a></p>	P	<p>Minolta Portugal Lda  Av. do Brasil 33-a, P-1700 Lisboa, Portugal  Tel: 01793 00 16  Fax: 01 793 10 64  <a href="http://www.minoltaeurope.com">http://www.minoltaeurope.com</a></p>
E	<p>Videosonic S.A.  c/ Valportillo II, 8, Pol. Ind. de Alcobendas,  E-28108 Alcobendas/Madrid, Spain  Tel: 91 4840077  Fax: 91 4840079  <a href="http://www.minoltaeurope.com">http://www.minoltaeurope.com</a></p>	S	<p>Minolta Svenska AB  P. O. Box 9058, Albygatan 114, S-17109  Solna, Sverige  Tel: 08 627 76 50  Fax: 08 627 76 21  <a href="http://www.minolta.se">http://www.minolta.se</a></p>
F	<p>Minolta France S. A.  365, Route de Saint-Germain,  F-78420 Carrières-Sur-Seine, France  Tel: 0130 86 62 37  Fax: 0130 86 62 82  <a href="http://www.minolta.fr">http://www.minolta.fr</a></p>	Sin	<p>Minolta Singapore (Pte) Limited  10 Teban Gardens Crescent, Singapore  2260  Tel: 56 35 533  Fax: 56 10 217  <a href="http://www.minolta.com">http://www.minolta.com</a></p>
FIN	<p>Minolta Finland Branch  Niittykatu 6, PL 37 SF-02201 Espoo, Finland  Tel: 435 565 0  Fax: 435 565 56  <a href="http://www.minolta.fi">http://www.minolta.fi</a></p>		